

FD-243024

EPA 550/9 - 81-420
N-96-01
II-A-169

COMMUNITY NOISE ASSESSMENT MANUAL
COMPUTER PROGRAMS FOR THE STRATEGY GUIDELINES FOR
DEVELOPING A COMMUNITY NOISE CONTROL PROGRAM

July 1981



U.S. ENVIRONMENTAL PROTECTION AGENCY
Office of Noise Abatement and Control
Washington, D.C. 20460

This report has been approved for general availability. The contents of this report reflect the views of the contractor, who is responsible for the facts and the accuracy of the data presented herein. This report does not necessarily reflect the official views or policy of EPA. This report does not constitute a standard, specification, or regulation.

TECHNICAL REPORT DATA		
(Please read instructions on the reverse before completing)		
1. REPORT NO. EPA 550/9-81-420	2.	3. RECIPIENT'S ACCESSION NO. N-96-01 II-A-169
4. TITLE AND SUBTITLE Computer Programs for the Strategy Guidelines for Developing a Community Noise Control Program	5. REPORT DATE July 1981	6. PERFORMING ORGANIZATION CODE
7. AUTHOR(S) Patrick K. Glenn	8. PERFORMING ORGANIZATION REPORT NO.	
9. PERFORMING ORGANIZATION NAME AND ADDRESS Wyle Research El Segundo, CA 90245	10. PROGRAM ELEMENT NO.	11. CONTRACT/GRANT NO.
12. SPONSORING AGENCY NAME AND ADDRESS U.S. Environmental Protection Agency 401 M Street, S.W. Washington, D.C. 20460	13. TYPE OF REPORT AND PERIOD COVERED	14. SPONSORING AGENCY CODE
15. SUPPLEMENTARY NOTES		
16. ABSTRACT This report was prepared by EPA, Office of Noise Abatement and Control, in support of its function to provide technical assistance to communities. It is one of nine which comprises the Community Noise Assessment Manual. The Manual provides a comprehensive and computerized system for assessing the noise problems of a community and then planning a noise control strategy for its abatement. This report provides a copy of the computer programs required for running the "Strategy Guidelines for Developing a Community Noise Control Program." The programs have been written for a UNIVAC 1108. The source language used is FORTRAN IV. A listing of the source programs are included in the report.		
17. KEY WORDS AND DOCUMENT ANALYSIS		
a. DESCRIPTORS	b. IDENTIFIERS/OPEN ENDED TERMS	c. COSATI Field/Group
18. DISTRIBUTION STATEMENT Releasable to the public	19. SECURITY CLASS (This Report) Unclassified	21. NO. OF PAGES 144
	20. SECURITY CLASS (This page) Unclassified	22. PRICE

FOREWORD

This report was prepared for the Motor Vehicle Manufacturers Association of the United States under Agreement Number WYL 7704-C2.1 entitled 'Community Noise Countermeasures Cost Effectiveness Computer Program (NOIZOP) and Documentation', effective September 20, 1976.

The original version of NOIZOP was written by Charles Coughlin in 1974, and implemented on an IBM 370 operated by Tymshare, Inc. The version of NOIZOP described in this manual represents a significant improvement over the original version and was developed by the author of this manual in 1976 on a Univac 1108 operated by University Computing Company. For reference purposes, the version of NOIZOP described herein will be referred to as version 2.1. The source language (FORTRAN IV) used conforms to ANSI standards to facilitate possible transfer of NOIZOP to other computers.

This document consists of three volumes. Volume I is the User's Guide. Volume II contains Appendix A, the listing of the source programs. Volume III contains Appendices B and C. Appendix B discusses the theory behind program generation as well as the general command and data flow. Appendix C gives an explanation of the program variables contained in COMMON blocks (storage areas jointly used by several subroutines).

The concepts according to which NOIZOP operates were developed in a study for the Motor Vehicle Manufacturers Association of the United States documented in Wyle Research Report WCR 75-2, by Racki, R., Sutherland, L., Swing, J., entitled COMMUNITY NOISE COUNTERMEASURES COST-EFFECTIVENESS ANALYSIS, and dated July 1975. That study was performed on the city of Spokane, Washington, as a typical community, using the original NOIZOP version. Since then, many significant improvements to concepts as well as to NOIZOP have been made. At the time of this writing, it was contemplated to reexamine the Spokane study in the light of these improvements.

Chapter 1 of this volume provides a general overview and introduction, briefly examining the program's purpose, capabilities, and limitations. This should provide a potential user enough information to decide whether NOIZOP can suit his application.

All subsequent chapters are intended for the actual user, supplying all information necessary to utilize NOIZOP to the

FOREWORD

fullest of its capabilities, Chapter 3 is a reference for debugging input data errors. The examples of Chapter 5 present actual applications to clarify the text of the previous chapters. The user may find it helpful to refer to these examples as he is reading through the text.

DEPT. OF AERONAUTICS AND SPACE

TABLE OF CONTENTS

	Page Number
1. Introduction and Basic Concepts.....	1-1
1.1 Background.....	1-1
1.2 Basic Concepts and Program Limitations.....	1-2
1.3 Definitions.....	1-5
1.4 N01Z0P Flow Diagram.....	1-6
2. Input Deck Structure.....	2-1
2.1 Input of Master Data Set.....	2-5
2.2 Countermeasure Definition.....	2-14
2.3 Cost Function Input.....	2-24
2.4 Barrier Definitions.....	2-29
2.5 Soundproofing Data and Path Receiver Options Selection.....	2-34
2.6 Stationary Source Data.....	2-38
2.7 Transfer Function Options.....	2-41
2.8 Data Factoring.....	2-51
2.9 Base Index Calculation.....	2-54
2.10 Source Ranking.....	2-56
2.11 Countermeasures Cost Effectiveness Optimization.....	2-58
2.11.1 Control Parameters.....	2-58
2.11.2 Interpretation of Output.....	2-61
2.11.3 Short Form Output.....	2-68
2.12 Program Termination.....	2-71

TABLE OF CONTENTS

	Page Number
3. Diagnostic and Error Messages.....	3-1
4. Special Considerations for NOIZBP Application.....	4-1
4.1 System Control Cards for Execution of NOIZBP on University Computing Company Univac 1108.....	4-1
4.2 Two Dimensions with Type 15 Countermeasures.....	4-5
5. Examples of NOIZBP Data Input.....	5-1
5.1 A Simple Demonstration Case.....	5-1
5.2 Example: San Francisco Bay Region Study Area II.....	5-18

LIST OF TABLES

	Approximate Page Number
Table 2-1	Codewords Recognized by N0IZ0P.....2-1
Table 2-2	Suggested Usage of Land Use Codes.....2-7
Table 2-3	Stationary Source Countermeasure Options.....2-18
Table 2-4	Path-Receiver Countermeasure Options.....2-19
Table 2-5	Countermeasure Type Codes.....2-20
Table 2-6	Countermeasure Definition Data.....2-21
Table 2-7	Default Transfer Function Conditions.....2-41
Table 2-8	Use of Option Parameters with CRIT Option....2-41
Table 2-9	Summary of Option Parameters.....2-65

LIST OF FIGURES

	Approximate Page Number
Figure 1-1	N81Z8P General Flow Diagram.....1-7
Figure 2-1	Input Deck Structure.....2-2
Figure 2-2	Output Resulting from Cell Data Input.....2-12
Figure 2-3	Example of Cell Data Echo Print.....2-12
Figure 2-4	Sample Printout Due to CM Codeword.....2-22
Figure 2-5	Sample Printout Due to CBST Codeword.....2-27
Figure 2-6	Sample Printout Due to BAR Codeword.....2-33
Figure 2-7	Sample Printout Due to PARE Codeword.....2-37
Figure 2-8	Sample Printout Due to STAS Codeword.....2-40
Figure 2-9	Linear and Power Law Transfer Functions.....2-45
Figure 2-10	Cosine Transfer Function.....2-46
Figure 2-11	Inverse Sine Transfer Function.....2-47
Figure 2-12	Inverse Power Law Transfer Function.....2-48
Figure 2-13	Sample Printout Due to CRIT Codeword, Changing Transfer Function Shape.....2-49
Figure 2-14	Sample Printout Due to CRIT Codeword, Changing Criterion Levels.....2-49
Figure 2-15	Sample Printout Due to FAC Codeword.....2-53
Figure 2-16	Sample Printout Due to BASE Codeword.....2-54
Figure 2-17	Sample Printout Due to RANK Codeword.....2-56
Figure 2-18	Sample Printout Due to OPT Codeword.....2-61
Figure 2-19	Three-Dimensional Illustration of Steepest Descent Path Optimization Method.....2-65
Figure 2-20	Sample Short Form Output.....2-69

DEPT. OF CIVIL ENGINEERING

LIST OF FIGURES

Approximate
Page Number

Figure 4-1 Illustration of Scale Transformation for
Type 15 Countermeasure:.....4-7

Figure 4-2 Practical Example of Scale Transformation
for Type 15 Countermeasure.....4-7

Figure 5-1 Input Stream for Simple
Demonstration Case.....5-2

Figure 5-2 Output of Simple Demonstration Case.....5-3

Figure 5-3 Input Stream for San Francisco Example.....5-21

Figure 5-4 San Francisco Example Secondary Output.....5-28

Figure 5-5 Noise Impact Index as a Function
of Expenditures.....5-30

Figure 5-6 Output of San Francisco Example.....5-31

NOISE USER'S GUIDE

INTRODUCTION

CHAPTER 1

INTRODUCTION AND BASIC CONCEPTS

1.1 Background

Historically, the need for this computer program (NOISE) arose when a study was begun that had as its ultimate goal the development of a tool for rational and objective decision making in policy and regulatory activity concerning environmental acoustic noise from all sources. Simply stated, the problem was to distribute a given hypothetical sum of money in such a way as to obtain the greatest possible benefit in terms of reduction of the number of people adversely affected by environmental noise. This is a problem of operations research, and it was quickly recognized that an involved computer program would be required to properly handle the task. The inherent non-linearity of the mathematics describing the problem prevented the use of well developed methods of linear algebra. A step-by-step gradient method was developed and implemented for finding the most cost-effective way of distributing the given sum of money.

For purposes of a mathematical formulation of the problem, a quantity was defined that rates the quality of the environmental noise climate of a community. This quantity is called the Noise Impact Index, abbreviated to NII:

$$NII = \frac{\text{NUMBER OF PEOPLE ADVERSELY AFFECTED BY NOISE}}{\text{TOTAL NUMBER OF PEOPLE}}$$

*NII = 0 means
no people impacted
by noise*

Clearly, the NII may vary between zero and one. The noise climate quality improves with declining NII. In operations research language, the NII is the objective function (i.e., it is the single function to be minimized by the judicious distribution of the given sum of money).

In order to evaluate changes in the NII, the concept of the 'countermeasure' was created. Countermeasures relate expenditures of money to specific effects of removing people from the list of those adversely affected by noise. Examples of countermeasures

NOIZOP USER'S GUIDE

INTRODUCTION

are:

- Reducing the noise level emitted by trucks,
- Changing the flight path of commercial jet aircraft,
- Moving people to quieter areas,

The community is specified to NOIZOP as a collection of cells grouped into zones. A cell usually comprises several city blocks and has a population which is exposed to the noise from all sources.

The basic task performed by NOIZOP is, for a specified distribution of expenditures, to apply the countermeasures at each cell, noting the number of people no longer adversely affected by noise, and computing a new (reduced) NII. This task is performed a large number of times during any one execution of NOIZOP as it searches for the distribution of expenditures which gives the greatest NII reduction for a given budget. x4

1.2 Basic Concepts and Program Limitations

The concept of the 'countermeasure' was introduced above. The concept of the 'cell' was created in order to organize the community under analysis into manageable portions. Cells are grouped into zones. A cell is assumed to be acoustically homogeneous, i.e., it is reasonable to lump all of its population into a central point of the cell; it is at that point that the noise levels from all sources (traffic, aircraft, etc.) are evaluated (for more details and justification of the concepts refer to the Spokane study mentioned in the preface). As far as the computer program is concerned, a cell exists simply by having been given an identification number. It is important to note that the program does not know a cell's geographical location, nor its location relative to other cells. This means that the program does not perform calculations which depend on geographical location, or on the separation of the receiver from a noise source. Such calculations (e.g., propagation losses) must be carried out beforehand during the stage of input data preparation for NOIZOP which then provides a sophisticated bookkeeping system for noise countermeasures, and cost-effectiveness optimization algorithms. Nor is the program concerned with the physical nature of the noise sources. The existence of a noise source is made known to the program by giving it a name and a sequence number, and by

Later Wyle position groups cells under a zone (which has homogeneity)

NOIZOP USER'S GUIDE

INTRODUCTION

specifying as input data the noise level the source generates at each cell. The program is therefore not concerned with such things as traffic density and speed, aircraft altitude, thickness of a building wall, etc., Of course, the person preparing the input data will deeply concern himself with these items, and possibly use other computer models (such as traffic noise models) for calculating noise levels, transmission losses, and cost data, etc.

Up to two cells may be specified at one cell 'location': day cells are different from night cells in that they contain different populations, are exposed to different noise levels, and exhibit different sensitivity of people to noise. If two cells are specified at one cell location, two cells must be counted when adding up the total number of cells.

See Wyle
Obtain copy of
sampling method
for selecting
representative
cell samples.

NOIZOP Version 2.1 is designed to accept up to a total of 200 cells. This may not be sufficient if a good size community is to be fully analyzed. However, a method of judiciously (not randomly) selecting a representative cell sample has been developed and is documented elsewhere (*). Use of this deterministic sampling method will rarely necessitate the use of more than 100 cells for one community. The program can be modified to accept more cells. Depending on the computer configuration, this may necessitate the use of 'large core' options, or of peripheral devices for intermediate data storage, such as is available with 'virtual core' systems.

NOIZOP can also be used for evaluating the relative merits of strategies in noise regulation for future time periods. A data factoring facility is available which allows making selective and overall adjustments to the input data in order to model a time period different from that for which the input data was generated.

NOIZOP uses the energy summation principle throughout for adding and subtracting noise levels; two levels, L1 and L2, are added according to:

$$L = 10 \cdot L_{10} (10^{L1/10} + 10^{L2/10})$$

where the ' \cdot ' signifies multiplication and the ' ** ' signifies exponentiation. In the cell-by-cell input data, all noise levels

(*) As yet unpublished work by Wyle Research.

*MUST OBTAIN
JAPRA 10/24/76*

DRIFT CORRECT SYSTEM

NOIZOP USER'S GUIDE

INTRODUCTION

should be specified in terms of energy equivalent levels (Leq), separately for day and night.

When the number of people adversely affected by noise at a cell is calculated, the above noise level summation is carried out for all noise sources. The resulting noise level is used to enter a 'transfer function' which relates the noise level to the fraction of people expected to suffer an adverse affect due to noise.

NOIZOP will issue an error message and not execute when one of the following conditions exist (this is not an exhaustive list):

- More than 200 cells,
- More than 20 stationary sources,
- More than 20 types of noise sources (other than stationary),
- More than 20 countermeasures,
- More than 100 sound barriers.

Most of the above restrictions are due to memory limitations imposed by storage assignment values. Moderate expansion of the above restrictions may involve some minor modifications to basic program functions.

The next section in this chapter defines several terms and concepts more rigorously. The last section of this chapter presents a simplified flow diagram of NOIZOP.

NOI20P USER'S GUIDE

INTRODUCTION

1.3 Definitions

Throughout this manual, there are references to terms and concepts which may be better understood with the establishment of the following definitions.

- ** A countermeasure is an action or a series of coordinated actions leading to a reduction of the degree of noise exposure of people.
- ** An expenditure is the commitment of funds required to implement a countermeasure.
- ** Cost functions define the effectiveness of each countermeasure in utilizing expenditures for reducing the degree of noise exposure of people.
- ** Baseline refers to the condition when no countermeasures have been applied.
- ** Present year refers to a point in time for which the raw input data applies. Target year refers to a later point in time and a condition of the input data as modified by the data factoring facility in NOI20P (see Section 2.8). The final analysis (expenditure allocation optimization) is carried out for the target year.
- ** An indicator is an auxiliary data item used in conjunction with countermeasures. It may have various functions depending on the countermeasure type. Many indicators must be calculated by the user and specified in the input data.

N01Z0P USER'S GUIDE

INTRODUCTION.

1.4 N01Z0P Flow Diagram

Figure 1-1 shows a simplified flow diagram of N01Z0P. The control module accepts commands from the input stream and reacts in basically three ways:

- Read more input data.
- Perform calculations on the side.
- Evaluate the NII and modify expenditures until the budget is exhausted; at which time (due to the process described in Section 2.11) the minimum NII for the given budget and the associated most cost-effective expenditure distribution over the defined countermeasures has been found.

NOIZOP USER'S GUIDE

INTRODUCTION

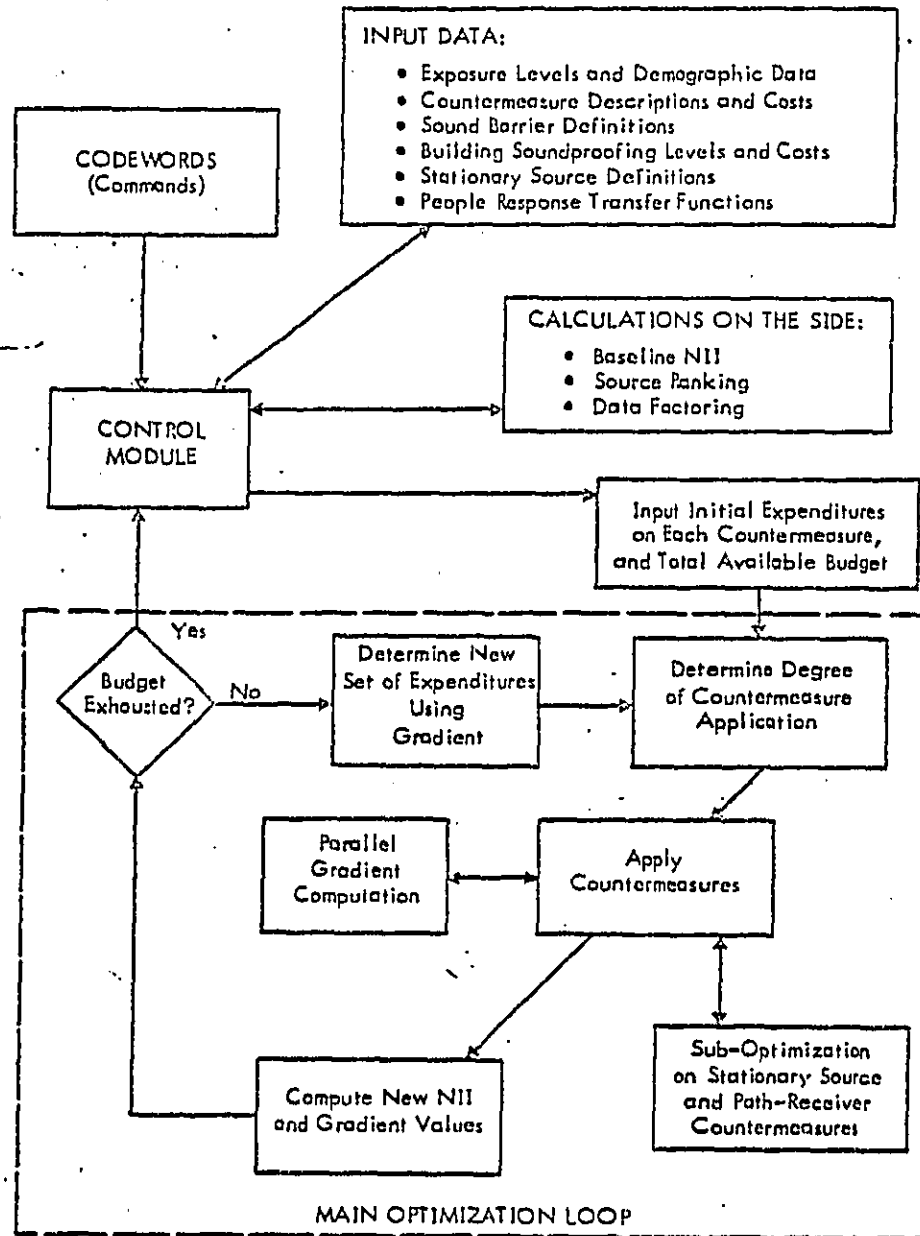

Figure 1-1. NOIZOP General Flow Diagram

NOIZOP USER'S GUIDE

DATA INPUT

CHAPTER 2

INPUT DECK STRUCTURE

Program operation is controlled by codewords which initiate program functions. The input deck consists of a number of sections which are identified by the codeword on the first card of each section. Each section causes execution of a certain program function module.

Each codeword consists of a pre-defined string of two, three, or four alphabetic characters descriptive of the function. Table 2-1 is a listing of these pre-defined codewords (in alphabetical order) recognized by the program.

These codewords occupy the first four columns of the codeword card and must be left justified in the field. A codeword initiated program function may have up to two associated option parameters. These two option parameters are input as integers and must be right-justified in each of two fields on the codeword card, columns 5 and 6, and columns 7 and 8. A blank field initiates the default handling of that option. A specific description of these option parameters will be included in each section describing the associated codeword.

Following the option parameters, starting in column 9 of the codeword card, the user may insert any title pertinent to the user's application for that codeword. This title may be up to 40 characters long and will appear on the printed output.

The user may note the prolific use of title cards in this program. It is suggested that the user make full use of titles; reasons for certain actions and references for data identification tend to be items of information that become very valuable when later referring to your work.

The following sections in this manual will describe in detail the sub-structure of each of the program modules in the approximate order in which they would appear in the input deck.

NOIZ8P USER'S GUIDE

DATA INPUT

Table 2-1
Codewords Recognized by NOIZ8P

CSDWORD	BASIC FUNCTION
BAR	Input of Barrier Definitions.
BASE	Compute Noise Impact Index for Baseline Case.
CM	Definition of Countermeasures.
CSST	Definition of Cost Functions.
CRIT	Transfer Function Modifications.
DTA	Input of Cell Data Set.
END	Termination of Job.
FAC	Data Factoring.
GPT	Initiate Optimization Process.
PARE	Input of Soundproofing Data.
RANK	Compute a Ranking of the Noise Sources by Adverse Effect.
STAS	Input of Stationary Source Data.

Immediately preceding the collection of codeword sections (see Figure 2-1) in the input deck there must appear three cards.

Card 1 contains the necessary information regarding an optional auxiliary or secondary print file to be sent to a teletypewriter type terminal. This file will contain a short-form of the program output which will give the user, who does not have immediate access to a line printer, the essential results of the program as well as any error

N01Z0P USER'S GUIDE

DATA INPUT

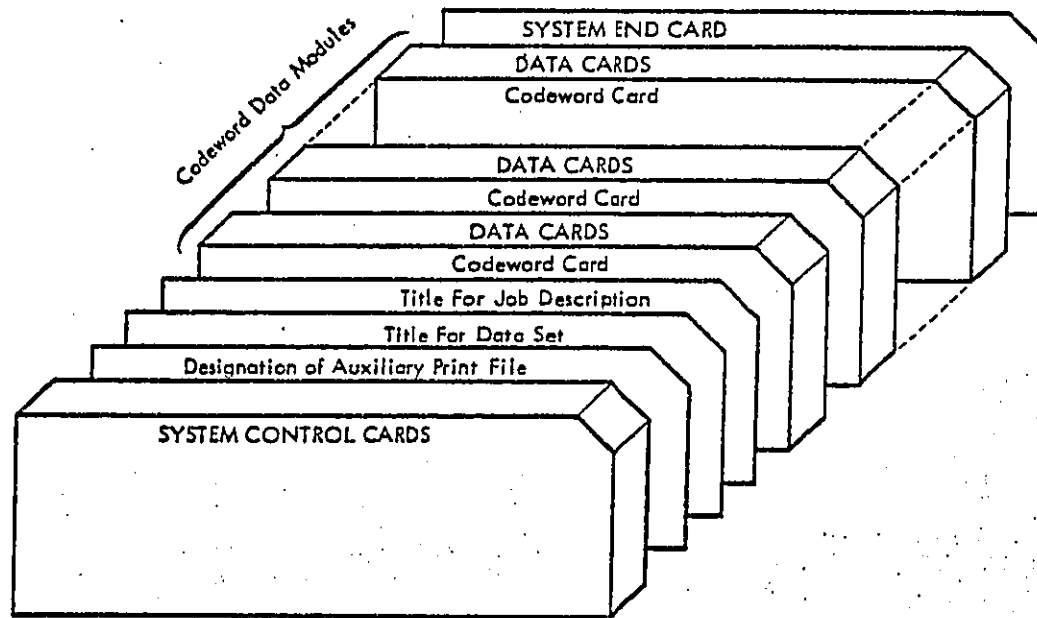

Figure 2-1. Input Deck Structure (see Section 4.1 for a detailed description of the control cards needed to execute the program on the University Computing Company UNIVAC 1100).

N01Z0P USER'S GUIDE

DATA INPUT

messages that may have resulted from improper input data. An example of this short-form output is presented in section 2.11.3.

This auxiliary file will be created if the user places a 'T' in column 1 of the first card. An 'F' or a blank in column 1 will suppress the creation of the auxiliary print file. If the auxiliary file is desired, the user must also input the Fortran logical unit number of the device to which this secondary print file will be output in column 4 of this card. Note that this unit number must also appear in an 'FCL' command before N01Z0P is executed (see SYSTEM CONTROL CARDS, section 4.1).

Card 2 is a title card describing the cell data set for the current job. All 80 columns may be used.

Card 3 is another title card which is used as a description for the job. This description can be useful when referring to a particular run. All 80 columns may be used. This title will also appear in the optional short-form output, however, in the shortened form the first 40 columns will be printed on one line and the second 40 columns on a second line. Hence, a word may appear broken in the short form output.

NB120P USER'S GUIDE

DATA INPUT

At each cell location, the user may specify levels from up to two stationary sources. The user might specify source titles such as 'STATIONARY SOURCE NO. 1' and 'STATIONARY SOURCE NO. 2'. These are source titles which are used to describe data fields in the master data set and are not related to the numbers (up to 20) assigned to the individual stationary sources in the community. The program is informed as to which actual stationary sources affect a particular cell by the use of countermeasure manipulation indicators (see Section 2.2, countermeasure definition, CM).

Following the source title cards, the user must place the array of elements (ones or zeroes) for source contribution for baseline case index evaluation. This array consists of 20 integers, one for each source, Format 20I2. A zero in the i-th field indicates that the i-th source is not to be considered in the computation of the baseline index. The user will normally define a source that should not be considered when a type 1 countermeasure is defined for that source (see section 2.2, countermeasure definition, CM). A source not to be considered will usually refer to alternate levels from another defined source. An example of such a source may be rerouted aircraft. In the baseline condition no aircraft are rerouted and, therefore, there should be no contribution from the rerouted source.

The remainder of the data cards following contain the necessary data specific to each defined cell. Up to five cards per cell may be needed to enter all the data.

Field:	1	2	b	3	4	5	6	7	8
Column:	1	4		1 1	1	2	3	3	3
				0 1	8	5	2	9	

157
Input

Card 1 (see above diagram; 'b' indicates a blank field) contains various parameters necessary for cell definition.

Field 1 - the zone number for the cell, I format.

Field 2 - the number of the cell within the zone, I format. A cell number greater than 100 implies the cell is defined during the nighttime period. As such, there is a maximum of 99 cell locations per zone. A day is generally acknowledged to be defined from 7 a.m. to 10 p.m., and a night from 12 p.m. to 7 a.m. and 10 p.m. to 12 p.m. Therefore, the program assumes that the day is 15 hours long.

NO120P USER'S GUIDE

DATA INPUT

and the night is 9 hours long. To define a cell over 24 hours, two cells must be defined, one for the day, and one for the night. The night cell number will be the day cell number plus 100.

- Field 3 - must contain a '1' signifying card type 1.
- Field 4 - the population of the cell during the specified time period, F format. If a person is present in the cell during both day and nighttime, then he should be counted twice, once in the population of the day cell, and once in the population of the night cell. The program will weight the input population figures for the time over which the cell is defined.
- Field 5 - contains the cost to relocate all people in the cell in thousands of dollars, F format. (Relocation costs usually consist of property values plus moving expenses). Specifying a cost greater than 999 million dollars is equivalent to inhibiting consideration of people relocation in this cell (see sections 2.2 and 2.5, Path-Receiver Countermeasures).
- Field 6 - the total floor area within the cell in thousands of square feet, F format. This value is used in the computation of soundproofing costs for this cell (see sections 2.2 and 2.5, Path-Receiver Countermeasures).
- Field 7 - specifies the lower criterion level for this cell, either I or F format is acceptable. The value specified must be an integer, that is, it must not have a fractional part. The lower criterion level is the decibel level at which zero percent of the people will be adversely affected by noise. These levels are usually a function of the land use type. Table 2-2 contains suggested values for lower criterion levels. That section also provides a facility for entering the lower criterion levels on the basis of land use. If that facility is used, field 7 can be left blank.
- Field 8 - contains the land use code for the cell, either I or F format is acceptable. The land use code is an integer value ranging from 1 to a maximum of 15. Table 2-2 contains suggested uses of land use codes.

NOISEP USER'S GUIDE

DATA INPUT

Table 2-2
Suggested Usage of Land Use Codes

Land Use Code	Suggested Usage	Suggested Lower Criterion Levels (0 per-cent adverse response, dB)	
		DAY	NIGHT
1	Single and Two-family Residential	54	46
2	Open for Additional Residential Use	54	46
3	Single, Two, and Multifamily Residential	54	46
4	Multifamily Residential	59	46
5	Business and Commercial	59	59
6	Wholesale and Warehousing	59	59
7	Central Business District	59	59
8	Industrial	70	70
9	Public and Semi-public Areas		
10	Parks	55	—
11	Schools	55	—
12	Hospitals and Nursing Homes	50	50
13	Open		
14	Open		
15	Open		

NOIZOP USER'S GUIDE

DATA INPUT

Field:	1	2	3	4	5	6	7	8
Column:	1	4	1 1	1	2	3	3	
			0 1	8	5	2	9	
(cont.)				9	10	11	12	13
				4	5	6	6	7
				6	3	0	7	4

Card 2 (see diagram above which is also applicable to cards 3, 4, and 5) contains the decibel levels for noise sources 1-10.

Fields 1-2 - are the same as for card type 1

Field 3 - contains a '2' for card type 2.

Fields 4-13 - are the source levels for noise sources, 1-10 respectively, F format.

Card 3 contains the decibel levels for noise sources 11-20.

Fields 1-2 - are the same as for card type 1.

Field 3 - contains a '3' for card type 3.

Fields 4-13 - are the source levels for noise sources 11-20, respectively, F format.

Card 4 contains countermeasure manipulation indicators 1-10.

Fields 1-2 - are the same as for card type 1.

Field 3 - contains a '4' for card type 4.

Fields 4-13 - are countermeasure indicators 1-10, respectively, F format. Although the input is in F format, indicators are always integer values. The user can ignore the format by right-adjusting the number in the field. The user should also note that any indicators which are equivalent for both the day and the night cell must be entered in the appropriate field for both cells. Note that if indicator values are the same over all cells, they may be input using the 'IND' feature described below. In this case, the appropriate field may be left blank.

NOIZOP USER'S GUIDE

DATA INPUT

Card 5 contains countermeasure manipulation indicators 11-20.

Fields 1-2 - are the same as for card type 1.

Field 3 - contains a '5' for card type 5.

Fields 4-13 - are countermeasure indicators 11-20, respectively, F format.

A blank card must follow the last cell data card. The program has room for up to 200 cells, counting day cells and night cells as separate cells.

There is an important restriction placed on the order in which the cell data cards must be placed. The cells must be input in order of ascending zone numbers. In addition, within a zone the cells must be placed in order of ascending cell number. Ane zone can contain from 1 to 99 cell locations. There is no restriction to the total number of zones as long as the maximum number of cells does not exceed 200. The usefulness of grouping cells into zones becomes apparent when studying the section on data factoring of this manual. When a large community is analyzed, cells will be naturally grouped into zones by their geographical proximity. Those cells designated as nighttime cells, numbers greater than 100, should not be treated as having large cell numbers for the purpose of numerically arranging cells within a zone. In fact, the '1' in the 1xx is stripped away and used separately. As such, for cell ordering within a zone, the night version of a cell must be placed immediately following the associated day version.

Card type 1 must precede cards type 2-5 within a cell, however, there is no restriction on the order of cards type 2-5 following card 1. There is no necessity to include cards type 2, 3, 4, and 5 if they are not all needed. For example, if there are only 8 defined sources and 3 indicators, then cards type 3 and 5 would be omitted. The program will not allow the user, however, to omit card type 1.

Following the blank card which terminates the cell data cards, the user may place a card with the letters 'IND' in columns 1-3. Following this card the user may input countermeasure indicators which are constant (have the same numerical value) for all cells. This feature relieves the user of the tedious chore of entering the same number in the appropriate field for every cell. Since 'IND' is an option apart from the main program, the user must indicate beforehand that the option will be employed. This is

NOIZ8P USER'S GUIDE

DATA INPUT

done by placing a non-zero integer in the option parameter field indicated by 'J' on the DTA codeword card. Following the 'IND' card, if that option has been implemented, the user places cards containing the constant indicator values. As many cards as necessary can be input, one card per indicator. A blank card signals an end to the constant indicator cards and returns control back to the main program. The constant indicator cards have the following format:

```
Field:      1          2
           |----|-----|
Column:  1          6
```

Field 1 - indicator number, I format,

Field 2 - actual indicator value, I format,

Figure 2-2 illustrates a sample output resulting from cell data input. This output was the result of card input lines 4 through 218 in Figure 5-3. Figure 2-3 indicates the format of the 'echo input' feature (initiated with a non-zero integer in the 'I' option parameter field). This output reflects the constant indicators which are input in lines 219 through 226 of Figure 5-3. The first line of each data set at the right hand side of the page is the levels from noise sources 1 through 10, line number 2 is for noise sources 11 through 20, Line number 3 is for indicators 1 through 10, line number 4 is for indicators 11 through 20. This feature is also an option of the data factoring facility (see section 2.8, data factoring, FAC). Also note that indicator numbers 19 and 20 may be reserved for special use (see section on barrier definition, BAR).

DTA 11

MASTER DATA FOR SA II, LOW RELOC. COSTS

SOURCES

INDICATORS

1 AUTOMOBILES LOW SPEED LINE SRC	1 NEW AUTOS LO SP+LOC.TRAFF.SRC.RED., CM = 1
2 AUTOMOBILES HIGH SPEED LINE SRC	2 EXIST.AUTOS LO SP+LOC.TRAFF.SC.RED, CM = 3
3 AUTOMOBILES LOCAL TRAFFIC SOURCE	3 TRUCKS LO SP NEW VEH SOURCE RED., CM = 4.
4 TRUCKS LOW SPEED LINE SRC.	4 TRUCKS LO SP ENFORC.+RETROF.SC.RED, CM = 5
5 TRUCKS HIGH SPEED LINE SRC.	5 TRUCK TIRES SOURCE RED., CM = 6
6 MOTORCYCLES LOW SPEED LINE SRC.	6 AIRCRAFT SAM TREATMENT, CM = 9
7 MOTORCYCLES LOCAL TRAFFIC SOURCE	7 RAILROAD LOCO SOURCE RED, CM = 12
8 BUSES LOW SPEED LINE SRC.	
9 RAILROAD LOCOMOTIVES, LINE S.	
10 RAILROAD CARS, LINE SOURCE	
11 AIRCRAFT COMMERCIAL, FLIGHT	

SOURCE CONTRIBUTION ELEMENTS FOR BASELINE INDEX:

1 1 1 1 1 1 1 1 1 1 1 0 0 0 0 0 0 0 0 0 0

DATA ENTERED FOR 78 CELLS

Figure 2-2. Output Resulting From Cell Data Input.

DATA INPUT

N9129P USER'S GUIDE

MCR 76-15

2-12

NOIZOP USER'S GUIDE

DATA INPUT

2.2 Countermeasure Definition

```
CM          ANY APPROPRIATE TITLE
|-----|-----|-----|-----|-----|-----|-----|-----|
| 1       | 5       | 7       | 9       |
```

To examine possible noise abatement strategies, the user may define up to 20 countermeasures. This section will describe in detail the various types of countermeasures the user may define and how to implement them. The CM codeword has no associated option parameters. In the following, 'indicators' are referred to which are used in countermeasure manipulation and have different meanings for different countermeasure types. Indicator values are contained in the master data set and are specified individually for each cell. They are utilized by the countermeasures as described below. A 'countermeasure variable' indicates the quantity varied by a countermeasure when money is spent on that countermeasure.

The exact input format is given after the description of all countermeasure types. The format will illustrate the mechanics of countermeasure definition and specification.

Type 1. A type 1 countermeasure is used for effecting cumulative noise reduction either through reducing the frequency of noise source generation or by rerouting the path of a moving noise source. There is no associated indicator. If the countermeasure is used to describe a reduction in the frequency of operations of a noise source, the countermeasure variable becomes the fraction of operations that are curtailed. This variable can have extreme limits of 0. (no operations curtailed) to 1.0 (all operations curtailed). The reduction is the same for both day and nighttime periods; i.e., the same for all cells. In general, countermeasures may be defined to apply to two sources. However, a frequency reduction countermeasure can apply to one source only, hence, a second source must not be defined. The user may, of course, define more than one frequency reduction countermeasure, each applying to a different source.

If a second source is defined for a type 1 countermeasure, then this countermeasure is treated as implying source relocation or rerouting. The first source number refers to field elements in the input cell data set that contain exposure from the source in its original position. The second source number refers to exposure that would be measured if the entire source were relocated or

NR12SP USER'S GUIDE

DATA INPUT

rerouted. The countermeasure variable becomes the fraction of the source population moved. This variable must fall in the range 0, to 1.0.

Type 3. This type of countermeasure refers to frequency reductions in night operations only. It may apply to one or two sources. There is no associated indicator. The countermeasure variable is the fraction of night operations eliminated.

Type 5. Curfews are type 5 countermeasures. To the program a curfew is defined as an operation that transfers nighttime activity into the daytime period. A reduction in night operations will be accompanied by a corresponding increase in daytime operations. The curfew may apply to one or two sources. An indicator is required for each source defined to be affected by this countermeasure. This indicator contains the portion (expressed in hundredths of a percent) of total acoustic energy that is received from that source during the nighttime period at each cell location. A cell location refers to the actual space occupied by both the day and the night versions of a cell. Each cell location may have a different exposure value. The countermeasure variable is the fraction of the night operations shifted to day. If the variable is negative, it refers to the fraction of day operations shifted to the nighttime period. Thus the variable may range from -1.0 to +1.0. However, under normal application (night operations to day) the feasible range will be specified as 0.0 to 1.0.

The user should note that the program does not verify the existence of the day or night cell into which the noise energy will be transferred. If the user neglects to define the night version of a cell location the application of this countermeasure will be erroneous because the energy increase during the day version will not be compensated for by a decrease in the night version. Note also that the nocturnal energy indicator must be input with both the day and night version of the cell location in the data set.

Type 10. A type 10 countermeasure is used to describe the application of a device which produces a fixed noise reduction. This device is applied to a fraction of the source population. This fraction is the countermeasure variable and may range from 0, to 1.0. The device may be applied to two sources. An example of how two sources may be utilized follows:

NOISE USER'S GUIDE

DATA INPUT

If the countermeasure consisted of applying new mufflers to locomotives, but freight and passenger trains were separate noise sources in the input data, both sources would be used in the countermeasure definition. If, however, the mufflers were to be applied preferentially to the locomotives pulling freight trains, two separate type 10 countermeasures would be required; one for each source.

A type 10 countermeasure utilizes one indicator to be calculated by the user: Given dB1 and dB2 as the source level reductions at the cell location from sources 1 and 2 respectively, and both reductions are expressed to the nearest 0.5 dB, then the indicator is defined at that cell as:

$$I = (dB1 \times 2 + 200) \times 1000 + (dB2 \times 2 + 200)$$

Note that either dB1 or dB2, or both, may be zero; in the latter case the resulting indicator would be equal to 200200. The program will recognize an indicator value of zero (or a blank data field) as being equivalent to 200200. Since indicators of this type will tend to be constant for every cell, the user may find the 'IND' feature of cell data input to be convenient (see DTA codeword description). The alternative would be to place the same number in the appropriate indicator field for every cell in the data set.

Type 12. This type of countermeasure defines straight Leq reductions in source levels. The countermeasure variable is the decibel reduction in the source level. One or two sources may be considered and there are no associated indicators. If the countermeasure applies to two sources the reduction is the same for each of them. The source Leq reduction is the same for all cells in the community.

Type 15. This type of countermeasure is very similar to a type 10 countermeasure. The difference lies in the fact that if two different devices are applied to the same source population, the second device is applied exclusively to that portion of the source population left untreated by the first device. Whereas with type 10 countermeasures, the second device would be applied proportionately to treated and untreated segments of the source population alike. Hence, type 15 countermeasures are useful only when more than one is defined to affect the same source. The countermeasure variable for each type 15 countermeasure is the

NSIZOP USER'S GUIDE

DATA INPUT

fraction of the source noise energy produced by the fraction of the source population to be treated with the device. The user should take care that the total fractional application of all type 15 countermeasures applying to any single source does not exceed unity. This can be assured by careful selection of the feasible range of each of these countermeasures which is input with the cost functions. An error message will be printed if, during the optimization process, it is found that the fractional application on any one source exceeds unity. An example of the use of type 15 countermeasures follows:

Two-dimensional cost functions can be synthesized by the use of two type 15 countermeasures. Two-dimensional cost functions determine a single noise reduction parameter by the application of two countermeasures. Assume that two sources are also affected by the countermeasures: 1.) Vehicle noise produced by automobiles on arterials, and 2.) Vehicle noise produced by traffic on collector type streets.

During the preliminary stage of input data preparation these two sources required different mathematical models to predict the levels. One axis of the two-dimensional countermeasure cost function describes retrofit of a muffler device on vehicles in non-compliance with municipal statutes. The other axis of the function specifies alternatives for new vehicle noise regulations. The user wishes to obtain the optimum combination of retrofit regulations and new vehicle regulations. Two type 15 countermeasures are defined, each with arterial traffic as the first noise source and collector traffic as the second source. The user has determined that 10 percent of the noise energy from vehicles is due to new vehicles and 90 percent from older vehicles. Note that these fractions are portions of energy rather than the composition of the vehicle fleet. The user has also calculated that the maximum decibel reduction possible from retrofit of older vehicles is 8 dB and a maximum benefit from new vehicles of 6 dB. These decibel values apply to both noise sources defined. The user defines the feasible range of the countermeasure variable for new vehicles as 0. to 0.1 and the range for older vehicles of 0. to 0.9. This would physically be entered with the cost functions. Finally, the decibel values (placed in the correct format, see type 10) would be entered with the cell data as the actual indicator values, which would be constant over all cells and identical for both sources. In fact,

NOISE USER'S GUIDE

DATA INPUT

the indicator could be entered once, and the field number in which the indicator was placed could be referred to for both sources. Refer to Section 4.2 for further details on the use of type 15 countermeasures.

Type 18. All stationary source countermeasures are grouped into a single countermeasure definition. The actual countermeasure options within the stationary source countermeasure are listed in Table 2-3.

Table 2-3
Stationary Source Countermeasure Options

- | |
|--|
| 1. Minimum Reduction |
| 2. Maximum Reduction |
| 3. Elimination of Night Operations |
| 4. Elimination of the Source |
| 5. Elimination of Night Operations and Minimum Reduction |
| 6. Elimination of Night Operations and Maximum Reduction |

Up to 20 stationary sources may be defined in the community (see STAS codeword description, Section 2.6). The program will decide which options are to be taken with each source. A listing of the results will be contained in the output following the optimization results (see OPT codeword description).

The master data set contains noise exposure levels for up to two stationary sources at each cell. The numbers of these stationary sources are given by two indicators also contained in the master data set for each cell (see DTA codeword description).

Type 20. Type 20 refers to path-receiver countermeasures. As

NOISEP USER'S GUIDE

DATA INPUT

with stationary sources, all path-receiver measures are combined into one countermeasure definition. A listing of all possible path-receiver measures is shown in Table 2-4. There are no associated sources or indicators to consider in the definition.

Table 2-4
Path-Receiver Countermeasure Options

1. Minimum Soundproofing
2. Medium Soundproofing
3. Maximum Soundproofing
4. Low Barriers
5. High Barriers
6. Relocation
7. Minimum Soundproofing and Low Barriers
8. Medium Soundproofing and Low Barriers
9. Maximum Soundproofing and Low Barriers
10. Minimum Soundproofing and High Barriers
11. Medium Soundproofing and High Barriers
12. Maximum Soundproofing and High Barriers

→ The following paragraphs describe the actual countermeasure definitions. Two cards are required for each countermeasure. A blank card follows the last set of definitions cards to signal return of control to the main program for input of another codeword. However, if the maximum number, 20, of countermeasures is defined, the blank card would not be necessary. Numbering of the countermeasures is done automatically as they are input. The

NOI20P USER'S GUIDE

DATA INPUT

user should note that the cost functions must appear in the same order as the countermeasures to which they correspond (see COST codeword description). The program will allow input of the countermeasure definitions before or after the cost functions have been input.

The countermeasures may be defined in any sequence the user wishes with one restriction: countermeasure types 18 and/or 20 (stationary source and path-receiver) must be the last to appear in the definition cards. The reason for this restriction is explained in the section on cost function input (COST). Tables 2-5 and 2-6 contain a summary of the countermeasures, their indicators and variables. Figure 2-4 is a sample printout resulting from countermeasure definition. This output is the result of cards number 227 through 254 in Figure 5-3. The countermeasure definition card format follows:

Card 1 contains titling information for this countermeasure. The first 72 characters of the card may be used.

Card 2 consists of five data fields, Format 515.

Field:	1	2	3	4	5
Column:	1	6	1	1	2
			1	6	1

Field 1 - specifies the countermeasure type code (see Table 2-5).

Field 2 - the noise source number affected by this countermeasure.

Field 3 - the noise source number of a second source, if any, affected by this countermeasure.

Field 4 - contains the number of the indicator, if any, utilized in the computation for this countermeasure. The 'number of the indicator' actually refers to the position that the indicator value occupies on card types 4 and 5 (see master data input); beginning with indicator number one in field 4 of card 4, card type 4 contains indicators 1 through 10, and type 5 contains 11 through 20.

NOISE USER'S GUIDE

DATA INPUT

Table 2-5
Countermeasure Type Codes

Code Number	Countermeasure Definition
1	A reduction in the frequency of operation of the noise source. The fractional reduction is the same during the day and at night.
3	A reduction in the frequency of nighttime operation of the noise source.
5	A shifting of nighttime activity into the daytime period, or vice versa.
10	Application of a device that produces a fixed Leq reduction to a portion of the source population.
12	An overall Leq reduction.
15	Like 10, except that no further modifications are allowed to the treated portion of the source population.
18	Stationary source countermeasures.
20	Path or receiver modifications.

Field 5 - contains the number of a second countermeasure indicator, if required. Note that only countermeasure types 5 and 18 can have more than one indicator.

Table 2-6
Countermeasure Definition Data

Countermeasure Code Number	Indicator	Countermeasure Variable	
		Units	Extreme Range
1	NA	Fraction	0, to 1.
3	NA	Fraction	0, to 1.
5	Fraction of energy emitted during nighttime period (hundredths of a per-cent).	Fraction	-1, to 1.
10	Decibel reduction (special format, see text).	Fraction	0, to 1.
12	NA	Decibel	0, to (no program imposed limit)
15	Decibel reduction (special format, see text).	Fraction	0, to 1.
18	Stationary source number	NA	NA
20	NA	NA	NA

NOI20P USER'S GUIDE
DATA INPUT

```

*****
CM -0-0
*****
SA II COUNTERMEASURE DEFINITIONS

----- AUTOMOBILES LOW SPEED NEW VEHICLES SOURCE REDUCTION
COUNTERMEASURE 1 TYPE 15 'EXCL TRT' APPLIES TO: AUTOMOBILES LOW SPEED LINE SRC INDICATOR NO. 1
AUTOMOBILES LOCAL TRAFFIC SOURCE -0

----- AUTOMOBILES LOW SPEED ODS ENFORCEMENT
COUNTERMEASURE 2 TYPE 12 'ODS RED' APPLIES TO: AUTOMOBILES LOW SPEED LINE SRC INDICATOR NO. -0
AUTOMOBILES LOCAL TRAFFIC SOURCE -0

----- AUTOMOBILES LOW SPEED EXISTING VEHICLES RETROFIT SOURCE REDUCTION
COUNTERMEASURE 3 TYPE 15 'EXCL TRT' APPLIES TO: AUTOMOBILES LOW SPEED LINE SRC INDICATOR NO. 2
AUTOMOBILES LOCAL TRAFFIC SOURCE -0

----- TRUCKS LOW SPEED NEW VEHICLES SOURCE REDUCTION
COUNTERMEASURE 4 TYPE 15 'EXCL TRT' APPLIES TO: TRUCKS LOW SPEED LINE SRC. INDICATOR NO. 3

----- TRUCKS LOW SPEED ODS ENFORCEMENT AND RETROFIT SOURCE REDUCTION
COUNTERMEASURE 5 TYPE 15 'EXCL TRT' APPLIES TO: TRUCKS LOW SPEED LINE SRC. INDICATOR NO. 4

----- TRUCKS HIGH SPEED TIRE NOISE REDUCTION
COUNTERMEASURE 6 TYPE 10 'PART TRT' APPLIES TO: TRUCKS HIGH SPEED LINE SRC. INDICATOR NO. 5

----- BUSES LOW SPEED SOURCE REDUCTION, NEW AND EXISTING VEHICLES
COUNTERMEASURE 7 TYPE 12 'ODS RED' APPLIES TO: BUSES LOW SPEED LINE SRC. INDICATOR NO. -0

----- MOTORCYCLES LOW SPEED ODS ENFORCEMENT
COUNTERMEASURE 8 TYPE 12 'ODS RED' APPLIES TO: MOTORCYCLES LOW SPEED LINE SRC. INDICATOR NO. -0
MOTORCYCLES LOCAL TRAFFIC SOURCE -0

----- AIRCRAFT SOUND ABSORPTION MATERIAL FACELLE TREATMENT SOURCE REDUCTION
COUNTERMEASURE 9 TYPE 10 'PART TRT' APPLIES TO: AIRCRAFT COMMERCIAL, FLIGHT INDICATOR NO. 6

----- AIRCRAFT FLIGHT PATH REROUTING (EFFECTIVELY A FLIGHT FREQUENCY RED.)
COUNTERMEASURE 10 TYPE 1 'RED FREQ' APPLIES TO: AIRCRAFT COMMERCIAL, FLIGHT INDICATOR NO. -0

----- AIRCRAFT REDUCTION OF NIGHT OPERATIONS
COUNTERMEASURE 11 TYPE 3 'NITE RED' APPLIES TO: AIRCRAFT COMMERCIAL, FLIGHT INDICATOR NO. -0

----- RAILROAD LOCOMOTIVE MUFFLERS, SOURCE REDUCTION
COUNTERMEASURE 12 TYPE 10 'PART TRT' APPLIES TO: RAILROAD LOCOMOTIVES, LINE S. INDICATOR NO. 7

----- PATH-RECEIVER CONTROL INSULATION, BARRIERS, LAND ACQ. AND PEOPLE RELOC.
COUNTERMEASURE 13 TYPE 20 'P-R MOD' APPLIES TO: ALL SOURCES INDICATOR NO. -0

```

Figure 2-4. Sample Printout Due to CM Codeword

NOI20P USER'S GUIDE

DATA INPUT

2.3 Cost Function Input

```
      COST          ANY APPROPRIATE TITLE
-----|-----|-----|-----|-----|
      1      5 7 9
```

For each defined countermeasure, except types 18 and 20, there must be an associated cost function. These cost functions must be input in the same order as the countermeasure definitions. There are no option parameters recognized for this codeword.

The program will allow either the cost functions or the countermeasure definitions to be input first. This facility can allow the user to conduct several optimizations, each based on a different set of cost functions. The user simply initiates another COST codeword after the OPT codeword. The program will then have the new set of cost functions stored in memory and will compute an optimized expenditure scenario based on the new cost functions following the implementation of another OPT codeword.

It is important to note that costs for the stationary source and path-receiver countermeasures (types 18 and 20) are not input in this section. Since the cost functions must be input in the same order as the defined countermeasures, the user should verify that the stationary source and path-receiver countermeasures (if desired) are the last two that are defined. That is, the countermeasure definition cards (see section 2.2, countermeasure definition, CM) for these two countermeasures must follow the definition cards for all other countermeasure types. The user must input cost functions for all the other countermeasure types in the sequence in which they are defined in the countermeasure definition section.

Four data cards are required to define a cost function. A blank card must be placed following the last defined cost function to signal a return to the main program for input of another codeword. However, if the maximum number of cost functions, 20, was input, the blank card would not be necessary. Note that in this case there would be neither a stationary source nor a path receiver countermeasure defined.

Card 1 contains titling information for the cost function defined on the subsequent three cards. The first 72 columns of the card may be used.

NOI29P USER'S GUIDE

DATA INPUT

Card 2 contains the feasible range of the countermeasure variable. The countermeasure variable is either a decibel reduction or a fractional application of a device which produces a fixed decibel reduction (see section 2.2 on countermeasure definition, CM, for a complete description of countermeasure variables). The feasible range defines the limits of allowed countermeasure variable application. The Format is 2F10.0 with the first field defining the minimum allowed value and the second the maximum allowed value.

Card 3 contains the values of the countermeasure variable for which corresponding costs will be input on card 4. Up to eight values are allowed. Format 8F10.0. Extreme values at the feasible range defined on card 2 need not be defined. The program will perform a linear interpolation between the data points to create a piece-wise linear curve of up to seven segments. The feasible range values on card two define the bounds of the cost function regardless of the range of data points specified on this card. If necessary, linear extrapolation is performed to extend the function. If only one data point is specified, that countermeasure will remain fixed at that value of countermeasure application. The countermeasure variables should otherwise be listed in order of increasing countermeasure effectiveness.

Card 4 contains corresponding costs for each of the countermeasure variable data points specified on card 3. Costs must be input in thousands of dollars. Format 8F10.0.

It is conceptually important that the cost functions be strictly increasing and contain no discontinuities. The cost functions should not contain any discontinuous jumps in the countermeasure variable or have regions of constant countermeasure variable application for variable cost. In addition, negative numbers are not allowed and will result in an error message. The reason for these limitations on the form of the cost functions lies in the technique used by the program for optimization. The program calculates a countermeasure cost-effectiveness gradient based on a user-supplied expenditure increment. The components of the gradient vector determine which countermeasures are the most cost-effective at the current expenditure level. Discontinuous jumps are nonsensical because the function would not be single valued at that point. Discontinuous jumps at the origin to simulate an automatic noise reduction with no cost may not achieve the intended purpose because the program will not recognize that there is no cost associated with the benefit and, hence, may never

NOIZOP USER'S GUIDE

DATA INPUT

implement that countermeasure. Regions of constant benefit for variable cost will cause the program to stall on that countermeasure because the gradient of the function at that point is zero. Refer to the section on data factoring, FAC for simulation of certain desirable discontinuities.

Figure 2-5 illustrates a sample output which is the result of card images as seen in lines 255 through 304 of Figure 5-3.

HCR 76-15

2-27

COST -0-0

SA II (MENLO PARK) LOW COST FUNCTIONS

----- COST FUNCTION FOR AUTOMOBILES LOW SPEED NEW VEHICLES SOURCE RED., CASE 3

FEASIBLE RANGE OF CM VARIABLE:	.00	.000 TO	.432					
NOISE RED PARAMETER:	.00	.10	.20	.30	.43	-.00	-.00	-.00
CORRESPONDING COSTS:	.00	14.31	47.72	162.23	248.12	-.00	-.00	-.00

----- COST FUNCTION FOR AUTOMOBILES LOW SPEED QDS ENFORCEMENT

FEASIBLE RANGE OF CM VARIABLE:	.00	.000 TO	6.200					
NOISE RED PARAMETER:	.00	4.50	5.50	5.00	6.20	-.00	-.00	-.00
CORRESPONDING COSTS:	.00	.25	.76	3.12	12.44	-.00	-.00	-.00

----- COST FUNCTION FOR AUTOMOBILES LOW SP. EXIST. VEH. RETROFIT, CASE 2

FEASIBLE RANGE OF CM VARIABLE:	.00	.000 TO	.500					
NOISE RED PARAMETER:	.00	.21	.38	.51	.57	-.00	-.00	-.00
CORRESPONDING COSTS:	.00	.00	.21	.73	1.11	-.00	-.00	-.00

----- COST FUNCTION FOR TRUCKS LOW SPEED NEW VEH. SOURCE REDUCTION

FEASIBLE RANGE OF CM VARIABLE:	.00	.000 TO	.436					
NOISE RED PARAMETER:	.00	.20	.35	.41	.44	-.00	-.00	-.00
CORRESPONDING COSTS:	.00	31.81	63.62	143.15	222.67	-.00	-.00	-.00

----- COST FUNCTION FOR TRUCKS LOW SPEED QDS ENFORCEMENT AND RETROFIT SOURCE R

FEASIBLE RANGE OF CM VARIABLE:	.00	.000 TO	.564					
NOISE RED PARAMETER:	.00	.33	.41	.51	.56	-.00	-.00	-.00
CORRESPONDING COSTS:	.00	.09	4.00	32.00	143.00	-.00	-.00	-.00

----- COST FUNCTION FOR TRUCKS HI SPEED TIME NOISE REDUCTION

FEASIBLE RANGE OF CM VARIABLE:	.00	.000 TO	1.000					
NOISE RED PARAMETER:	.00	1.00	-.00	-.00	-.00	-.00	-.00	-.00
CORRESPONDING COSTS:	.00	42.00	-.00	-.00	-.00	-.00	-.00	-.00

----- COST FUNCTION FOR BUSES LOW SP. SOURCE RED., NEW AND EXIST. VEHICLES

FEASIBLE RANGE OF CM VARIABLE:	.00	.000 TO	6.780					
NOISE RED PARAMETER:	.00	.23	2.35	6.78	-.00	-.00	-.00	-.00
CORRESPONDING COSTS:	.00	.05	1.78	16.22	-.00	-.00	-.00	-.00

NOI20P USER'S GUIDE

DATA INPUT

Figure 2-5. Sample Printout Due to COST Codeword

WYLE LABORATORIES

DRIVE COPY/AVOID COPY

----- COST FUNCTION FOR MOTORCYCLES LOW SPEED DCS ENFORCEMENT									
FEASIBLE RANGE OF CM VARIABLE:	.000	TO	17.000						
NOISE RED PARAMETER:	.00		5.04	9.46	12.75	17.00	-.00	-.00	-.00
CORRESPONDING COSTS:	.00		.02	.06	.16	.50	-.00	-.00	-.00
----- COST FUNCTION FOR AIRCRAFT SAM SOURCE REDUCTION									
FEASIBLE RANGE OF CM VARIABLE:	.000	TO	1.000						
NOISE RED PARAMETER:	.00		1.00	-.00	-.00	-.00	-.00	-.00	-.00
CORRESPONDING COSTS:	.00		19.26	-.00	-.00	-.00	-.00	-.00	-.00
----- COST FUNCTION FOR AIRCRAFT FLIGHT PATH MANEUVERING (#FREQ. REDUCTION)									
FEASIBLE RANGE OF CM VARIABLE:	.000	TO	1.000						
NOISE RED PARAMETER:	.00		1.00	-.00	-.00	-.00	-.00	-.00	-.00
CORRESPONDING COSTS:	.00		9.07	-.00	-.00	-.00	-.00	-.00	-.00
----- COST FUNCTION FOR AIRCRAFT NIGHT OPERATIONS REDUCTION									
FEASIBLE RANGE OF CM VARIABLE:	.000	TO	1.000						
NOISE RED PARAMETER:	.00		1.00	-.00	-.00	-.00	-.00	-.00	-.00
CORRESPONDING COSTS:	.00		32.76	-.00	-.00	-.00	-.00	-.00	-.00
----- COST FUNCTION FOR LOCOMOTIVE MUFFLERS, SOURCE REDUCTION									
FEASIBLE RANGE OF CM VARIABLE:	.000	TO	1.000						
NOISE RED PARAMETER:	.00		1.00	-.00	-.00	-.00	-.00	-.00	-.00
CORRESPONDING COSTS:	.00		16.22	-.00	-.00	-.00	-.00	-.00	-.00

SUMMARY OF ALLOWED COST RANGES (\$000'S):

COUNTERMEASURE NUMBER	RANGE	
1	\$.00 TO \$	246.12
2	\$.00 TO \$	12.44
3	\$.00 TO \$	1.11
4	\$.00 TO \$	222.67
5	\$.00 TO \$	193.00
6	\$.00 TO \$	92.09
7	\$.00 TO \$	16.22
8	\$.00 TO \$.59
9	\$.00 TO \$	19.26
10	\$.00 TO \$	9.07
11	\$.00 TO \$	32.76
12	\$.00 TO \$	16.22

Figure 2-5 (Continued)

NOI20P USER'S GUIDE

DATA INPUT

MCR 76-15

2-28

UNCLASSIFIED

BEST COPY AVAILABLE

NOISE USER'S GUIDE

DATA INPUT

2.4 Barrier Definitions

```
BAR  I   ANY APPROPRIATE TITLE
|----|---|-----|
1    5 7 9
```

This section is used to input data defining barriers for the path-receiver countermeasure. This codeword is optional and is used only if the user has defined a path-receiver countermeasure. There is only one option parameter, identified by 'I' above and described later.

The first data card contains titling information. The first 72 columns of the card can be used.

The second and third cards contain the barrier effectiveness ratios. Card 2 contains effectiveness ratios for the 20 possible sources and a low barrier height. Card 3 contains the same information for a high barrier height.

The effectiveness ratio for a particular source is the dB reduction achieved by the barrier on that source divided by the dB reduction achieved by the barrier on a standard source of the user's choosing. Effectiveness ratios are used to allow for the fact that barrier effectiveness generally varies with the type of source.

For example, a barrier 15 feet high is found to attenuate automobile traffic levels by 10 dB. This same barrier has an effectiveness of only 8 dB on locomotive generated noise. It is decided that the height of the traffic noise source will be the standard height. The effectiveness ratio for the traffic noise source is 1.0 and the effectiveness ratio for the locomotive noise source is 0.8. Note that the effectiveness ratios for aircraft noise sources should be zero since barriers have no effect on airborne noise sources. Since the program allows the definition of two barrier heights at each location, effectiveness ratios must be supplied for a low barrier height and a high barrier height.

The array of effectiveness ratios for the high barrier height is independent of the array for the low barrier height. A standard source is selected to have an effectiveness ratio of 1.0 for the high barrier height and then the ratio is calculated for each of

N81ZGP USER'S GUIDE

DATA INPUT

the other sources at the high barrier height. This process is repeated for the low barrier height. A different standard source may be selected to have a ratio of 1.0 and the ratios are recalculated for the low barrier height. Note also that these ratios will be applicable to all defined barriers. The effectiveness ratio for any unused source number must be zero. Each of the two ratio cards has Format 20F4.0.

The remainder of the data cards contain the actual barrier definitions, one card per barrier. A blank card must appear after the last barrier definition card to return control to the main program for input of another codeword. The card contents are described below.

Fields:	1	2	3	4	5	6	7					
Column:	1	5	1 3	2 1	2 4	2 6	3 1					
(cont.)	8	9	10	11	12	13	14	15	16	17	18	19
	3	3	4	4	5	5	5	6	6	6	7	7
	6	9	1	6	1	4	6	1	6	9	1	6

Field 1 - Format I4, contains the barrier number. Up to 100 barriers are allowed. The barrier numbers do not need to be consecutive or sequential, no individual barrier number greater than 100 is allowed. Barrier numbers are actually barrier location numbers since both the low barrier and high barrier are referred to with the same number. Even though there is a limit of 100 barrier locations, there can actually be 200 defined barriers, 100 low, and 100 high. The computer program will decide which barrier height (if any) is the most cost-effective to build at the defined location.

Field 2 - Format F8.0, is the cost of building a low barrier at this location in thousands of dollars. Presumably, the user calculated this cost from the knowledge of the barrier length and the cost per linear foot of building low barriers.

Field 3 - Format F8.0, is the cost of building a high barrier at this location, in thousands of dollars. Note that the actual height of the barrier is not an input data item.

BEST COPY AVAILABLE

N01Z0P USER'S GUIDE

DATA INPUT

Only barrier effectiveness is specified in fields 6-7, 10-11, 14-15, 18-19 (they may not all be used). The user decides on the actual barrier heights, low and high, which, in turn, determine the effectiveness of each barrier.

Field 4 - Format I3, contains the zone number of the primary (adjacent) cell affected by this barrier (see section 2.1 for zone and cell specification).

Field 5 - Format I2, contains the cell number of the primary cell affected by this barrier. Only the day cell number is necessary, the program will automatically assign the barrier to the night cell (if any) as well.

Field 6 - Format F5.0, is the base attenuation at the population centroid of the primary cell for the low barrier. The base attenuation is the effectiveness of the barrier in decibels on the selected standard source. The standard source is one which has an effectiveness ratio of 1.0 for the low barrier height. The attenuation value may only be entered to a maximum accuracy of a tenth of a dB.

Field 7 - Format F5.0, is the base attenuation at the population centroid of the primary cell for the high barrier. This value is input in similar fashion to the low barrier attenuation. Maximum attenuation of a barrier is limited by the program at 24 dB. This value is considered to be a practical engineering limitation.

The previous four field definitions (4-7) are then repeated for up to three additional cells also affected by this barrier. These additional cells are not immediately adjacent to the barrier and are referred to as secondary cells for this barrier. A cell may be a secondary cell to more than one barrier.

Barrier data is stored in the program as indicators 19 and 20 (see section on countermeasure input, CM, for a definition of indicators). This assignment occurs automatically and requires no physical action on the part of the user. The user should also be aware that any countermeasure indicators numbered 19 or 20 will be lost if barriers are defined. That is, barrier input overwrites any information stored as indicators 19 and 20. Use of indicators

NOIZOP USER'S GUIDE

DATA INPUT

19 and 20 is allowable, however, if the BAR codeword is not implemented.

If a zone-cell combination is specified in the barrier definition cards which was not defined in the main cell data set, a message to that effect will be printed (see Chapter 3, Error Messages) and program execution will terminate. However, the option parameter can be used to suppress these messages and override program termination. This is accomplished by placing a non-zero value in the position occupied by the 'I' in the option parameter field on the codeword card illustrated at the beginning of this section.

This option would normally be employed by the user in the event that a large set of barrier definition cards had been developed for a large community. The user would be able to select separate sections of the community for analysis and leave the large set of barrier definition cards intact.

A sample printout resulting from barrier input is shown in Figure 2-6. See Figure 5-3, lines 305 through 318 for the card images which caused this output.

 BAR -0-0 BARRIER DATA 3A 11 LOW COST

----- BARRIERS FOR STUDY AREA 11 (MENLO PARK), LOW COST

BARRIER EFFECTIVENESS RATIOS:

			LOW	HIGH
1	AUTOMOBILES	LOW SPEED LINE SNC	1.25	1.50
2	AUTOMOBILES	HIGH SPEED LINE SNC	1.25	1.50
4	TRUCKS	LOW SPEED LINE SNC	1.00	1.40
5	TRUCKS	HIGH SPEED LINE SNC	1.10	1.50
6	MOTORCYCLES	LOW SPEED LINE SNC	1.25	1.50
8	BUSES	LOW SPEED LINE SNC	1.00	1.40
9	RAILROAD	LOCOMOTIVES, LINE 3.	.50	1.00
10	RAILROAD	CARS, LINE SOURCE	1.50	1.50

NBW	COSTS(\$1000'S)		PRIMARY CELL			SECONDARY CELLS					
	HT 1	HT 2	ID	DB1	DB2	ID	DB1	DB2	ID	DB1	DB2
* 1 *	37.6	55.0	23	1	0.0	0.0	0.0	0.0	0.0	0.0	0.0
* 2 *	167.2	248.4	22	1	10.0	10.0	22	2	0.0	0.0	0.0
* 3 *	167.2	248.4	21	1	10.0	10.0	21	2	0.0	0.0	0.0
* 4 *	51.9	77.1	20	1	10.0	10.0	0	0	0.0	0.0	0.0
* 6 *	192.9	289.7	6	1	10.0	10.0	6	2	0.0	0.0	0.0
* 7 *	505.1	759.0	17	1	10.0	10.0	17	2	0.0	0.0	0.0
* 8 *	257.0	386.0	10	1	10.0	10.0	0	0	0.0	0.0	0.0
* 9 *	432.7	649.9	9	1	10.0	10.0	9	2	0.0	0.0	0.0
* 10 *	171.3	257.3	16	1	10.0	10.0	0	0	0.0	0.0	0.0

Figure 2-6. Sample Printout Due to BAR Codeword

NOIZOP USER'S GUIDE

DATA INPUT

2.5 Soundproofing Data and Path Receiver Options Selection

```
PARE          ANY APPROPRIATE TITLE
|-----|-----|-----|-----|-----|
1      5 7 9
```

This section is used to input soundproofing data associated with the path-receiver countermeasure. If the user has not defined a path-receiver countermeasure, this codeword would not be implemented. If there is a path-receiver countermeasure this codeword must be implemented. There are no associated option parameters recognized by the program.

The codeword card must be followed by the following six data cards.

Card 1 is an additional title card which may be used for any purpose. The first 72 columns of the card may be used. The title will appear on the output.

Card 2 contains the path-receiver countermeasure option override array. One of the many NOIZOP program functions is to perform a cost/benefit analysis and to apply in an optimal manner the various path-receiver countermeasure alternatives. There are twelve such alternatives which are listed in Table 2-4. The user may, at his discretion, decide to eliminate any of these options from consideration. For example, the user may disallow barriers and soundproofing to be implemented in combination. This is accomplished through the use of the path-receiver countermeasure override array. The array consists of twelve integers. Format 1215, input on one card. A zero in the *i*-th field instructs the program to eliminate that option from consideration. A positive integer instructs the program to include that option. In our example just mentioned, the user would place a zero in fields 7 through 12, corresponding to options 7 - 12.

The relocation path-receiver option has additional features. As mentioned in the section on cell data input (DTA), an individual cell may be eliminated from consideration for relocation by specifying a relocation cost greater than 999 million dollars. In addition, possible relocation of any cells can be overridden by placing a zero in the sixth field of the override

NR120P USER'S GUIDE

DATA INPUT

array. The method the program uses to evaluate the potential benefits of relocation can also be controlled through the use of the override array. A positive integer in the sixth field will correct the benefit of relocation by considering the noise level of the area into which people are being moved. The program does not actually decide where to move people but assumes a noise level which will produce an adverse effect equal to one-half of a standard deviation below the mean residential adverse effect in the community. The residential cells are scanned and the mean and standard deviation are calculated. The current noise levels (i.e., after all non path-receiver countermeasures have been applied) are used in the calculation of these statistics. If there are no residential cells in the data set then the effect would be equivalent to removing the entire population as next described. A negative integer in the sixth field will instruct the program to treat relocation as a simple removal of people from the area, no attempt is made to maintain a closed system with a fixed number of people as is done with the alternate (statistical) option. The choice the user makes may affect the manner in which the user calculates the relocation costs.

Card 3 contains three decibel levels, Format 315, corresponding to the basic noise reduction for minimum, medium and maximum soundproofing, respectively, in residential dwellings. Residential cells are identified by a land use code of 1, 2, 3, or 4. Zeroes in any of the fields are normally not allowed and will result in an error message. If the user has cost data for only one or two levels of soundproofing, he may input a zero in an unwanted field and by-pass the error-checking facility just mentioned by placing a zero in the proper option field of the path-receiver option override array (card 2).

For example, only two levels of soundproofing are known. The user leaves the maximum soundproofing field blank and places a zero in the third field of the override array. Note, in this example, that any maximum soundproofing levels defined for non-residential cells (card 5) will also be by-passed.

Card 4 contains costs per square foot in dollars for each of the three levels of residential soundproofing defined on Card 3. The same rules for zeroes as on Card 3 also apply. The format is 3F10.0.

Card 5 contains three soundproofing levels for non-residential

NBIZQP USER'S GUIDE

DATA INPUT

cells in the same format as on Card 3.

Card 6 contains corresponding costs for the three non-residential soundproofing levels in the same format as on Card 4.

Figure 2-7 illustrates a sample printout resulting from the PARE codeword. See lines 319 through 325 of Figure 5-3 for the cards which caused this output.

PARE -0-0

----- SOUNDPROOFING DATA SA II (MENLO PARK), LOW COST ESTIMATES; ALL PR OPTION

P/R MOD OVERRIDE ARRAY:

1 1 1 1 1 1 1 1 1 1 1 1

RESIDENTIAL SOUNDPROOFING AND COST FACTORS (\$/SQ FT):

5 DB	10 DB	15 DB
2.25	6.44	11.68

COMMERCIAL SOUNDPROOFING AND COST FACTORS (\$/SQ FT):

5 DB	10 DB	15 DB
2.25	6.44	11.68

NOISEP USER'S GUIDE
DATA INPUT

Figure 2-7. Sample Printout Due to PARE Codeword

NOIZOP USER'S GUIDE

DATA INPUT

2.6 Stationary Source Data

```
STAS          ANY APPROPRIATE TITLE
|-----|---|-----|
1      5 7 9
```

This section is used to input data describing stationary sources. No option parameters are recognized. If there are no stationary sources or no stationary source countermeasure, this section is not used.

The first data card is a title card containing any appropriate information. The first 72 columns are read and the title appears on the output.

The second data card contains the stationary source countermeasure option override array, Format 615.

One of the many NOIZOP program functions is to decide, based on a cost/benefit analysis, which stationary source countermeasure options should be applied to which stationary source, constrained by the allowable expenditure on the stationary source countermeasure. These six options are listed in Table 2-3. The user may instruct the program to overlook the i-th option by placing a zero in the i-th field on the card. There are six possible stationary source countermeasure alternatives. Any or all of these may be eliminated from consideration. The following diagram illustrates a sample stationary source override array card.

```
      1 1 1 0 1 1
      |--|--|--|--|--|
Column: 1 3 5 7 9 1
              1
```

Following the override array are the actual stationary source data cards, one for each of up to twenty stationary sources. A blank card following the last stationary source data card returns control to the main program for input of another codeword.

The stationary source data card must contain seven items of information.

NOISZOP USER'S GUIDE

DATA INPUT

Field:	1	blank	2	3	4	5	
Column:	1		1	2	3	4	
			1	1	1	1	
				(cont.)		6	7
					5		6
					1		1

- Field 1 - Stationary source number, I format. These must be sequential beginning with number 1.
 - Field 2 - A minimum source level reduction for this stationary source, in decibels, F format.
 - Field 3 - A maximum source level reduction in decibels, F format.
 - Field 4 - Cost for the minimum level reduction, F format.
 - Field 5 - Cost for the maximum level reduction, F format.
 - Field 6 - Cost for elimination of nighttime operations.
 - Field 7 - Cost for elimination of the source altogether, F format.
- All costs are input in thousands of dollars.

Note that zeroes in any of the fields are normally not allowed. However, the stationary source override array may be used to allow input of zeroes in the fields if certain countermeasure alternatives have not been costed by the user or are simply not feasible options. For example, a zero in the fourth field of the override array card (see example diagram above) would allow an input cost of zero for the cost of source elimination. Note that any positive cost value in the cost field will be ignored if the appropriate override array field is zero. The reason for not allowing zeroes in the cost fields is to eliminate the 'something for nothing' cases which the program cannot handle directly. Also note that a zero entry in the override array applies to all stationary sources.

Figure 2-8 illustrates a sample output resulting from stationary source data input. This output is the result of input from cards as seen in lines 75 through 80 in Figure 5-1.

STAS -0-0 STATIONARY SOURCE INPUT

----- STATIONARY SOURCE SAMPLE INPUT

STATIONARY SOURCE OVERRIDE ARRAY:
1 1 1 1 1 1

STATIONARY SOURCES-

SOURCE	MIN.		MAX.		COSTS IN THOUSANDS		ELIM. SOURCE
	RED.	REQ.	RED.	REQ.	MAX. RED.	ELIM. NIGHT	
1	3.	5.	20.00	30.00	40.00	100.00	
2	6.	8.	20.00	30.00	40.00	100.00	

Figure 2-8. Sample Printout Due to STAS Codeword

NOIZOP USER'S GUIDE

DATA INPUT

2.7 Transfer Function Options

```
CRIT II J ANY APPROPRIATE TITLE
|-----|-----|-----|-----|
1      5 7 9
```

The transfer function, Φ , is used to relate the fraction of people adversely affected to the overall noise level.

The independent variables needed for function evaluation are the equivalent A-weighted level (L_{eq}) plus upper and lower bound criterion levels, L_{cu} and L_{cl} , respectively. For levels greater than L_{cu} , Φ equals 1 (see exception below) and for levels less than L_{cl} , Φ equals 0. However, the shape of the function in between these limits is not usually known with any great precision. Consequently, the user is given a choice of transfer function shapes for the intermediate region. The shape options are plotted in Figures 2-9 to 2-12.

The CRIT option is used to specify the shape and/or criterion limits of the transfer function to be used.

'II' and 'J' are the option parameters that control the transfer function changes to be made. Table 2-7 describes the default conditions in effect before the implementation of the CRIT option. These would be in effect if the CRIT codeword were not used.

As can be determined from Table 2-7 the transfer function takes on different limits depending on the land use type of the cell in question or whether the cell is defined over a day or a nighttime period.

Remember that the lower criterion level (zero percent adversely affected) is input with the cell data set separately for each cell and as such can be different for each cell; it is not confined to uniformity within the land use type. However, use of the CRIT option to change the lower criterion levels will change those levels to the same specified value at all cells within the land use type indicated. That is, no cell-selective changes are possible.

NOISEP USER'S GUIDE

DATA INPUT

Table 2-7
Default Transfer Function Conditions

Land Use Code	Upper Criterion Level (100 Percent Adverse Response), dB	
	Day	Night
1	85	77
2	85	77
3	85	77
4	90	77
5	90	85
6	90	85
7	90	85
8	90	85
9	85	85
10	85	85
11	85	85
12	85	85
13	85	85
14	85	85
15	85	85

Note: Default transfer function shape is linear (Type 1), default bulge factor is 0., and default maximum value is 1, i.e., not more than 100 percent people adversely affected. See Table 2-2 for suggested usage of those land use codes. The above levels were the product of a preliminary criterion analysis. It is recommended that the user specify upper criterion levels that are 20 dB greater than the lower criterion levels in Table 2-2. The 20 dB window is consistent with EPA recommended levels.

Table 2-8 summarizes the use of the 'II' and 'J' option parameters.

Note that if the transfer function for more than one but not all land use types are to receive modification, the CRIT option must be invoked as many times as is necessary.

There are a variable number of data cards depending on the

N0120P USER'S GUIDE

DATA INPUT

Table 2-8
Use of Option Parameters with CRIT Option

'II'	'J'
Land Use Types 1-15 0 = All Types	0 = Upper and lower criterion levels 1 = Lower criterion levels only 2 = Upper criterion levels only 3 = Transfer Function shape (0,1,2 - any one or all land use types 3 - always all land use types)

option indicated by the option parameters. If a single land use type is specified, then one card is required to change the upper criterion level and one card is required to change the lower criterion level. If 'J' equals 1 or 2, only one card is necessary; if 'J' equals 0, two cards are necessary; the first card containing the new day/night lower levels and the second card containing the new upper levels for the land use type indicated by 'II'. The levels card has Format 215.

Field 1 - contains the new criterion level (upper or lower) for each day cell of the specified land use type.

Field 2 - contains the new criterion level (upper or lower) for each night cell of the specified land use type.

If 'II' equals 0, 30 following data cards are required. The first 15 contain the new lower criterion levels for each of the 15 possible land use types, respectively, and the second 15 contain upper criterion levels for each of the 15 possible land use types. Blank cards or dummy values must be included for any unused land use types.

NOIZOP USER'S GUIDE

DATA INPUT.

If 'J' equals 3 then the 'II' parameter has no effect. There is only one data card. This card contains the new transfer function type number (1-5) and the new bulge factor, r. The format is: IS, FS, 0.

A Type 1 (linear) transfer function can be made to extend beyond the 100 percent adverse effect level ($\Phi = 1$). Normally the actual bulge factor value has no effect on a Type 1 transfer function, however, the function can be made to extend beyond the $\Phi = 1$ point by specifying any positive value for the bulge factor. Figures 2-9 to 2-12 also show the shape option number and the equation used for each option where:

$$X = (L - Lcl) / (Lcu - Lcl)$$

and,

$$Lcu > L > Lcl$$

L = Equivalent A-weighted Level (Leq)

Figures 2-13 and 2-14 show sample printouts from each of the two general types of usage of the CRIT option. Figure 2-13 was the result of cards from lines 326 through 327 of Figure 5-3. Figure 2-14 resulted from cards in lines 328 through 358 also from Figure 5-3.

NOIZOP USER'S GUIDE

DATA INPUT

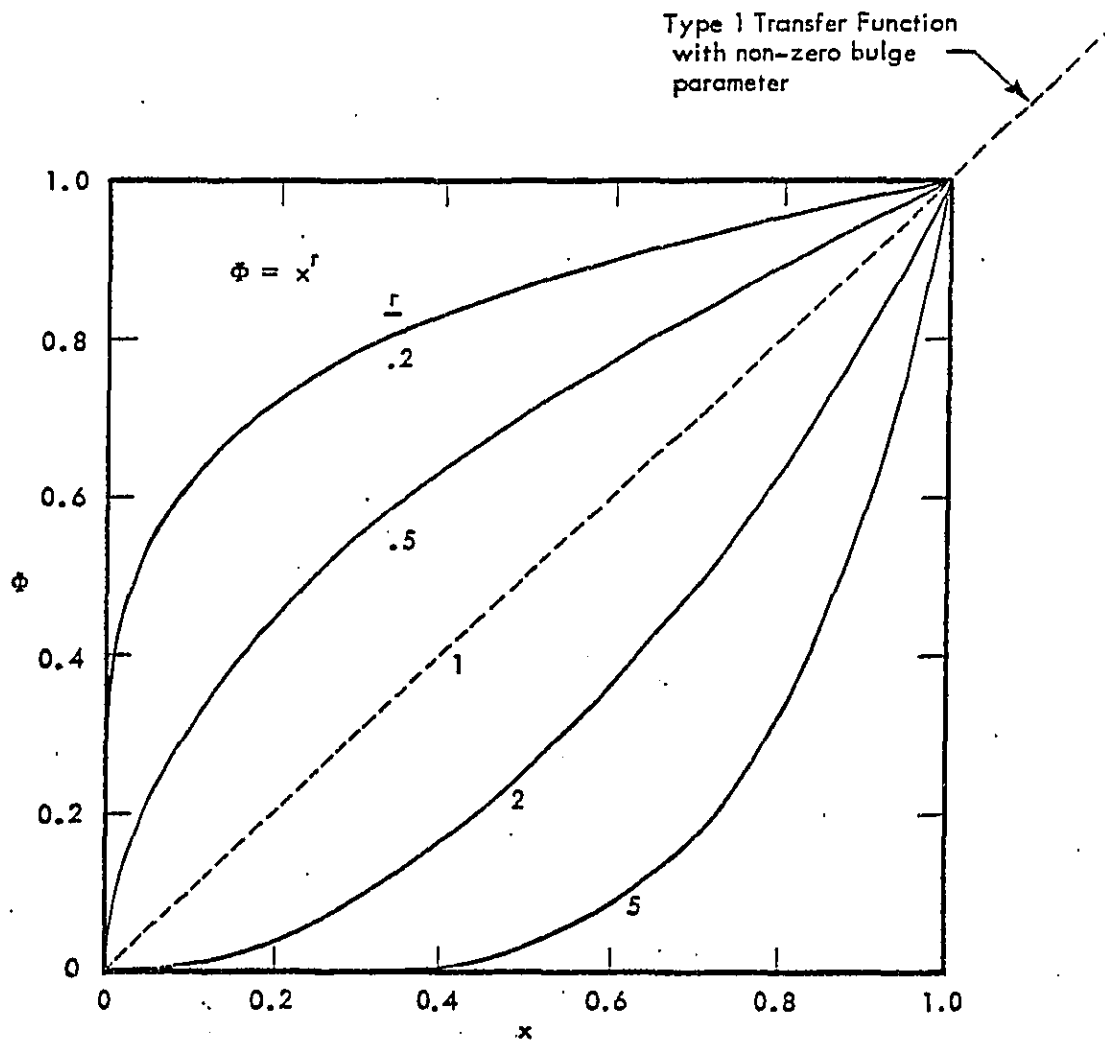

Figure 2-9. Linear Transfer Function, Type 1 (dashed line), and Power Law Transfer Function, Type 4 (solid lines).

(Linear Transfer Function, Type 1, occurs for $r = 1$ on a Type 4 transfer function. However, the bulge parameter has no effect on a Type 1 Transfer Function other than to indicate the maximum function value: 1.0 or greater than 1.0.)

NOISEP USER'S GUIDE

DATA INPUT

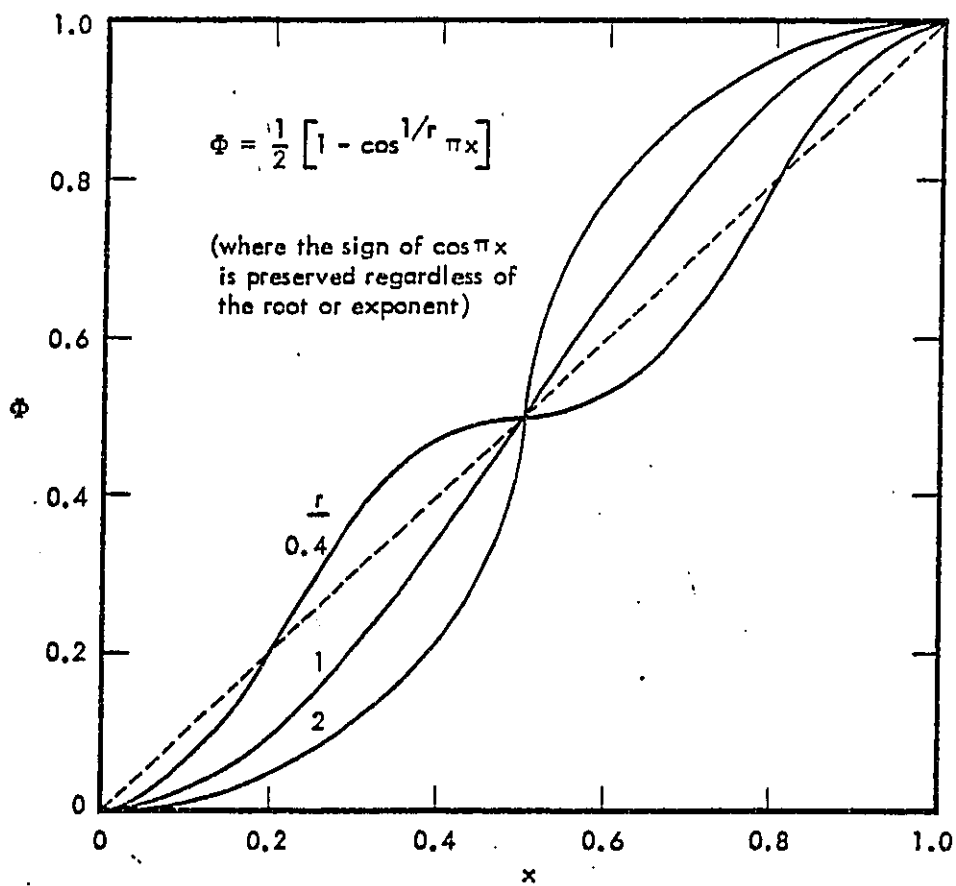

Figure 2-10. Cosine Transfer Function, Type 2

N01Z0P USER'S GUIDE

DATA INPUT

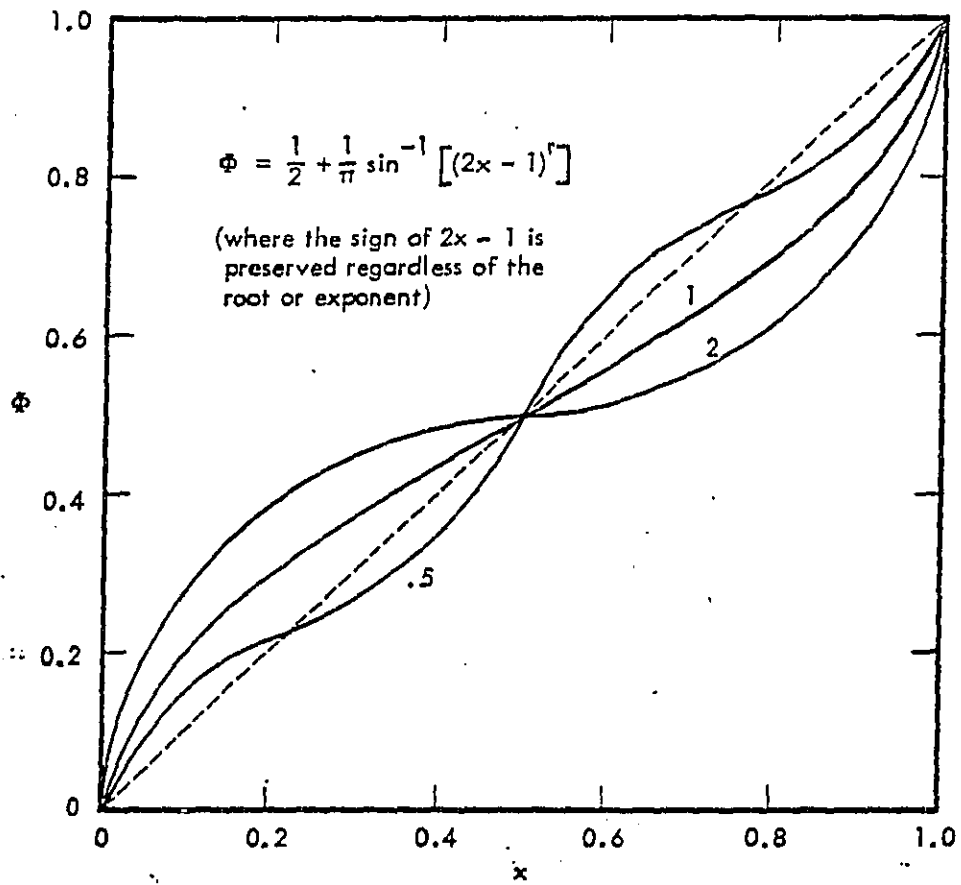

Figure 2-11. Inverse Sine Transfer Function, Type 3

N91Z8P USER'S GUIDE

DATA INPUT

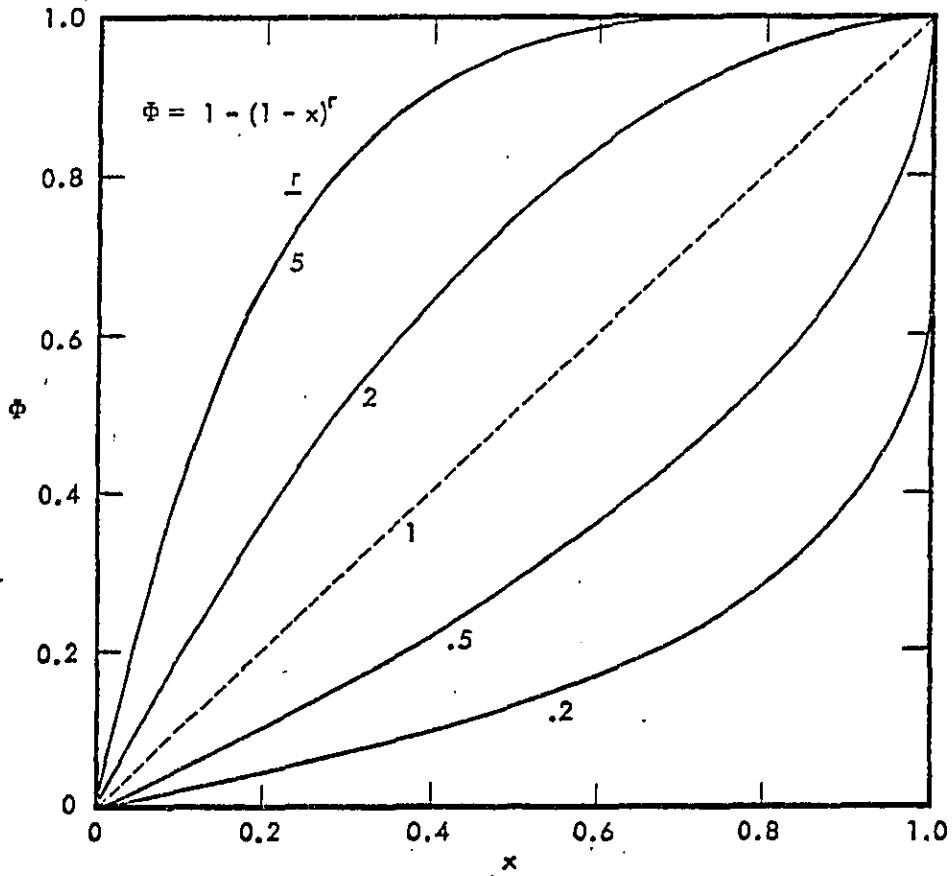

Figure 2-12. Inverse Power Law Transfer Function, Type 5

CRIT -0 3

ALLOW MORE THAN 100 PERC. ADV. EFFECT

TRANSFER FUNCTION TYPE 1 IN EFFECT WITH BULGE FACTOR OF 1.00

LINEAR FUNCTION ALLOWING MORE THAN 100 PERCENT ADVERSE EFFECT

Figure 2-13. Sample Printout Due to CRIT Codeword,
Changing Transfer Function Shape

CRIT 0 0 TRANSF.FCT. FOR SFU STUDY, 20 DB RANGE

LOWER CRITERION LEVELS OF	60	CELLS	TYPE	1	CHANGED TO	57	DBA(D)	AND	49	DBA(N)
LOWER CRITERION LEVELS OF	6	CELLS	TYPE	4	CHANGED TO	62	DBA(D)	AND	49	DBA(N)
LOWER CRITERION LEVELS OF	2	CELLS	TYPE	5	CHANGED TO	62	DBA(D)	AND	62	DBA(N)
LOWER CRITERION LEVELS OF	0	CELLS	TYPE	8	CHANGED TO	70	DBA(D)	AND	70	DBA(N)
LOWER CRITERION LEVELS OF	8	CELLS	TYPE	11	CHANGED TO	57	DBA(D)	AND	50	DBA(N)
LOWER CRITERION LEVELS OF	2	CELLS	TYPE	12	CHANGED TO	60	DBA(D)	AND	57	DBA(N)

UPPER CRITERION LEVELS OF	ALL	CELLS	TYPE	1	CHANGED TO	77	DBA(D)	AND	69	DBA(N)
UPPER CRITERION LEVELS OF	ALL	CELLS	TYPE	2	CHANGED TO	0	DBA(D)	AND	0	DBA(N)
UPPER CRITERION LEVELS OF	ALL	CELLS	TYPE	3	CHANGED TO	0	DBA(D)	AND	0	DBA(N)
UPPER CRITERION LEVELS OF	ALL	CELLS	TYPE	4	CHANGED TO	82	DBA(D)	AND	69	DBA(N)
UPPER CRITERION LEVELS OF	ALL	CELLS	TYPE	5	CHANGED TO	82	DBA(D)	AND	82	DBA(N)
UPPER CRITERION LEVELS OF	ALL	CELLS	TYPE	6	CHANGED TO	0	DBA(D)	AND	0	DBA(N)
UPPER CRITERION LEVELS OF	ALL	CELLS	TYPE	7	CHANGED TO	0	DBA(D)	AND	0	DBA(N)
UPPER CRITERION LEVELS OF	ALL	CELLS	TYPE	8	CHANGED TO	90	DBA(D)	AND	90	DBA(N)
UPPER CRITERION LEVELS OF	ALL	CELLS	TYPE	9	CHANGED TO	0	DBA(D)	AND	0	DBA(N)
UPPER CRITERION LEVELS OF	ALL	CELLS	TYPE	10	CHANGED TO	0	DBA(D)	AND	0	DBA(N)
UPPER CRITERION LEVELS OF	ALL	CELLS	TYPE	11	CHANGED TO	77	DBA(D)	AND	0	DBA(N)
UPPER CRITERION LEVELS OF	ALL	CELLS	TYPE	12	CHANGED TO	80	DBA(D)	AND	77	DBA(N)
UPPER CRITERION LEVELS OF	ALL	CELLS	TYPE	13	CHANGED TO	0	DBA(D)	AND	0	DBA(N)
UPPER CRITERION LEVELS OF	ALL	CELLS	TYPE	14	CHANGED TO	0	DBA(D)	AND	0	DBA(N)
UPPER CRITERION LEVELS OF	ALL	CELLS	TYPE	15	CHANGED TO	0	DBA(D)	AND	0	DBA(N)

NOI29P USER'S GUIDE
DATA INPUT

Figure 2-14. Sample Printout Due to CRIT Codeword,
Changing Criterion Levels

NOISE USER'S GUIDE

DATA INPUT

2.8 Data Factoring

```
FAC 1 ANY APPROPRIATE TITLE
|-----|---|---|-----|
1 5 7 9
```

The FAC codeword is used to factor noise exposure values, population, and relocation cost. The purpose of the factoring is to update the data set from the year for which the data was calculated to a target year in which the countermeasures are to be implemented.

For example, operational data may be available for the noise sources in the current year 1976, but the countermeasures are to be implemented over a five year period and as such the cost functions reflect the costs to the year 1981. The countermeasure optimization is, therefore, to be based on the noise environment in the target year, 1981. The data factoring capability is used to simulate the noise environment in this target year using constant factors based on predicted trends.

Another example illustrates an application to simulate a 'something for nothing' countermeasure cost function.

Current vehicle noise regulations will result in a decrease in the overall vehicle fleet noise level in the target year even without the application of extra noise countermeasures. However, the cost-function for the vehicle noise countermeasure should not have any regions where noise reduction is achieved with zero additional cost (see section 2.3, cost function input, COST). Therefore, to force the program to accept the automatic noise reduction in the target year, the user employs the data factoring option to reduce overall vehicle noise to the predicted level. The cost function can thus be redefined to eliminate the troublesome region.

Factors for population growth (or decline) and property value can also be specified. These data factors can be made to apply to specific zones and/or specific land use types.

A nonzero integer in the option parameter field indicated by 'I' above will initiate a formatted output of the master cell data

NOISEP USER'S GUIDE

DATA INPUT

set as it appears following the data factoring. Note that if barriers are defined (BAR codeword), indicator fields 19 and 20 have been filled with data on barriers. The data consists of a number of up to six digits. The first three digits are the barrier number. The second three digits are the barrier attenuation in tenths of a dB.

FAC may be invoked as often as required. Five data cards are required each time:

Card 1 is a title card which will appear on the output, the first 72 characters may be used.

Card 2 contains zones and land use codes for which ratios apply. Format 615.

Field 1 - The number of the first zone for which ratios apply. A zero implies a start from the beginning of the data, i.e. the first zone.

Field 2 - The number of the last zone for which ratios apply. A zero implies that zones will be considered to the end of the data, i.e. the last zone.

Fields 3-6 - Land use codes for which ratios apply. Up to four may be specified. If none are input, i.e. four zeroes or blanks, all land uses will be considered.

Card 3 contains factors for population and property values respectively. Format 2F8.0.

Cards 4-5 contain noise energy factors for the 20 possible sources. Format 10F8.0. Example: If noise reduces by 4.3 dB, then the factor to input is $10^{*(-4.3/10)} = 0.3715$ (the two asterisks ** signify exponentiation).

Note that a factor of 1.0 will result in no change to the corresponding data item. Figure 2-15 illustrates a sample printout resulting from implementation of the data factoring option. This output was the result of card images as seen in lines 359 through 364 of Figure 5-3.

FAC 1-0

SFO BA II (HENLO PARK)

----- SIMULATE BASELINE MOTOR VEHICLE LEVELS (I.E., FOR NO ENFORCEMENT)

THE FOLLOWING FACTORS APPLY TO ZONES: 1- 25 AND CELLS: 1- 76
LAND USES: ALL

POPULATION AND PROPERTY VALUE FACTORS:

1.000000 1.000000

EXPOSURE FACTORS:

1.548100	1.000000	1.548100	2.236700	1.000000	1.724400	1.724400	1.000000	1.000000	1.000000
1.000000	-0.000000	-0.000000	-0.000000	-0.000000	-0.000000	-0.000000	-0.000000	-0.000000	-0.000000

Figure 2-15. Sample Printout Due to FAC Codeword

NOI20P USER'S GUIDE

DATA INPUT

2.9 Base Index Calculation

```
BASE      ANY APPROPRIATE TITLE
|-----|-----|-----|-----|-----|-----|-----|-----|
| 1      5      7      9
```

The BASE codeword is used to calculate the baseline Noise Impact Index (NII) for the community. The NII is the fraction of the people in the community which are adversely affected by their noise environment. There are no options or data cards for this codeword. The baseline index is calculated using the current data either in the raw form as input by the DTA codeword, or in an amended form due to the FAC codeword. Hence, the BASE codeword should appear after the DTA codeword in the input deck.

Normally the baseline index is meaningful in the target year before actual source level reductions are achieved through countermeasures. Therefore, the FAC codeword would normally be invoked before the BASE codeword. However, if all the input noise data is consistent to the present year, the user might be interested in the present day NII as well. As such, the BASE codeword may be invoked more than once, before and after data factoring (FAC codeword).

Calculation of the baseline index is optional, that is, this codeword does not have to be invoked. If it is, however, it will allow a comparison to be made between baseline and final NII. The final NII being the noise impact index which has been optimized using the input countermeasure and cost functions together with budgeted expenditures. The comparison will be presented in the form of an NII reduction from the baseline and a final cost/benefit ratio. The cost/benefit ratio is defined to be dollar amount spent per person in the community to achieve the reduction in NII.

Figure 2-16 is a sample output from the BASE function. This output was caused by the codeword card seen in line 365 of Figure 5-3. The NII value seen is for the cell data also defined in Figure 5-3.

BASE -0-0

FOR AN AVE POPULATION OF 3305. PERSONS, THE BASELINE NOISE IMPACT INDEX/101 .579245

Figure 2-16. Sample Printout Due to BASE Codeword

NOISEP USER'S GUIDE
DATA INPUT

RCR 76-15

2-55

WYLE LABORATORIES

REPORT NUMBER: 76-15-2-55

NOISE USER'S GUIDE

DATA INPUT

2.10 Source Ranking

```
RANK      ANY APPROPRIATE TITLE
|-----|-----|-----|-----|
1      5  7  9
```

The RANK command initiates the computation of a ranking of the noise sources by adverse effect. There are no option-parameters or following data cards for this codeword.

The basis for the source ranking is the contribution to the Noise Impact Index (NII) which is due to each of the defined sources. The most offending noise source will be responsible for having the most adverse effect on the population.

The output of this calculation is the contribution to the NII from each of the 20 possible sources, the fractional contributions (sum to unity) to the NII from each of the 20 possible sources, and a listing of the noise sources in order of decreasing adverse impact. Figure 2-17 illustrates a sample output. The input card causing this output can be seen in line 366 of Figure 5-3. The sources and cell data used in this ranking are also defined in Figure 5-3.

This option functions much like the BASE codeword in that it employs the cell data set as it exists at the time the codeword is implemented; which may be before or after the optional data factoring (FAC) has been carried out. Hence, the user may be interested in obtaining a source ranking before and after the data factoring has taken place.

RANK -0-0

POPULATION WEIGHTED AVE INDICES FOR SOURCE RANKING:										SOURCES (1-10) / (11-20)	
.067116	.015178	.005290	.053056	.039825	.183512	.122751	.000376	.081579	.008599		
.001963	.000000	.000000	.000000	.000000	.000000	.000000	.000000	.000000	.000000	.000000	.000000

FRACTIONAL CONTRIBUTION TO NOISE IMPACT INDEX:										SOURCES (1-10) / (11-20)	
.115868	.026203	.009152	.091595	.068753	.316813	.211916	.000650	.140836	.014005		
.001389	.000000	.000000	.000000	.000000	.000000	.000000	.000000	.000000	.000000	.000000	.000000

MOST OFFENDING SOURCES:		SOURCE NO.
1	MOTORCYCLES LOW SPEED LINE SRC.	(6)
2	MOTORCYCLES LOCAL TRAFFIC SOURCE	(7)
3	RAILROAD LOCOMOTIVES, LINE 3.	(9)
4	AUTOMOBILES LOW SPEED LINE SRC.	(1)
5	TRUCKS LOW SPEED LINE SRC.	(4)
6	TRUCKS HIGH SPEED LINE SRC.	(5)
7	AUTOMOBILES HIGH SPEED LINE SRC.	(2)
8	RAILROAD CARS, LINE SOURCE	(10)
9	AUTOMOBILES LOCAL TRAFFIC SOURCE	(3)
10	AIRCRAFT COMMERCIAL, FLIGHT	(11)
11	BUSES LOW SPEED LINE SRC.	(8)

Figure 2-17. Sample Printout Due to RANK Codeword

NOI20P USER'S GUIDE

DATA INPUT

2.11 Countermeasure Cost Effectiveness Optimization

```
      SPT  I  J ANY APPROPRIATE TITLE  
|-----|-----|-----|  
1      5  7  9
```

2.11.1 Control Parameters

The SPT codeword is used to initiate the cost-effectiveness optimization process. The program uses a gradient method in the process of finding the optimal point representing that allocation of expenditures among the defined countermeasures which results in the smallest Noise Impact Index. The constraining factors in the NIJ minimization process consist of the maximum feasible application of any of the countermeasures and the user defined total budget for all countermeasure expenditures combined. In essence, then, the program will find the minimum Noise Impact Index that can be achieved with the amount of money that has been budgeted.

The option parameter indicated by 'I' above controls the detailed breakdown of the path-receiver countermeasure results. A zero in the field (default) will initiate a cell by cell listing of the particular path-receiver countermeasure options (see Table 2-4 for a listing of these options) employed at each of the cell locations. A nonzero integer in this field will suppress this listing. A detailed explanation of the printout is included later below.

The gradient value for a countermeasure is the change in the Noise Impact Index that would occur if an additional dollar were spent on that countermeasure alone.

The option parameter indicated by 'J' above controls the handling of the stationary source gradient evaluation. For various reasons, the calculation of the stationary source countermeasure gradient is quite complex, however, an approximation is very easily obtained. This approximation will always have a higher numerical value than the true gradient. The program will increase the expenditure level of only one countermeasure at a time. The criteria for selecting the countermeasure is based on gradient magnitude. The countermeasure with the largest gradient will receive the next expenditure increment (the determination of the

NOI20P USER'S GUIDE

DATA INPUT

actual increment value will be discussed later below). If the approximation to the stationary source gradient is not the largest of all the gradients then the actual magnitude of the stationary source countermeasure gradient is not important. A zero in the 'J' option parameter field (default) will allow the program to take advantage of this fact and suppress the procedure which calculates the actual gradient value. If the approximate gradient is the largest the actual value will then be calculated. Remember that the approximate value is always larger than the actual value. A non-zero integer in the 'J' option parameter field will cause the program to compute the actual gradient value at every point; resulting in increased execution time. This feature is included in the event that the user is interested in the true gradient values of the stationary source countermeasure at every point in the optimization process.

Up to three data cards are necessary to control the optimization process.

Cards 1-2 define the point at which the optimization process is to begin. These cards contain the initial expenditures on the countermeasures at which the user wishes the optimization process to commence. The initial values would normally be zero but this is not a restriction. The program will adjust these input expenditures to account for any minimum or maximum expenditure constraints on any of the countermeasures which were declared during countermeasure and cost definitions. The user must input an initial expenditure for each defined countermeasure. Ten expenditures can be placed on each card. Format 10F8.0. The values must be input in thousands of dollars. If there are ten or fewer defined countermeasures then only one card will be necessary; more than ten defined countermeasures requires the use of both cards.

Card 3 contains three control parameters, the total budget, the gradient stepsize, and the maximum initial expenditure ratio. The format is 3F10.0.

The total budget is the maximum allowed expenditure for all countermeasures together. The desired value is entered in millions of dollars.

The gradient step size is the dollar increment which the program will add to the current expenditure for each countermeasure to calculate the components of the gradient vector. Remember that the

N01Z0P USER'S GUIDE

DATA INPUT

gradient is calculated using the specified stepsize (not a step size of one dollar), but is presented as a per-dollar benefit. The stepsize must be entered in thousands of dollars. The default value (initiated by a blank field) is 10,000 dollars.

The initial maximum expenditure ratio governs the rate at which progress will be made toward reaching the optimum point. Beginning with the input initial expenditures, the program will spend additional funds on one countermeasure at a time until the total budget has been expended. The particular countermeasure that is selected for expenditure increase is the one that is the most cost-effective at that point (i.e., has the largest gradient). The actual additional dollar amount allocated to that countermeasure is determined by:

$$\text{Increment} = \text{MIN}(G1/Gn, \text{MAX}(Ir + Ca/Tb, 1)) * SS$$

where,

G1 = Largest component of the gradient vector
Gn = Second largest vector component
Ir = Initial maximum expenditure ratio
Ca = Current total expenditure on all countermeasures
Tb = Total allowed budget
SS = Gradient stepsize

'MIN' means take the smallest of the arguments within parentheses separated by commas, 'MAX' means take the largest of the arguments within the following parentheses,

As can be seen from the expression above, the initial ratio limits the coarseness of the steps which can be taken. The allowed coarseness is a decreasing linear function of expenditures which is why the input maximum expenditure ratio is referred to as 'initial'. Note that the increment is never allowed to fall below the gradient stepsize. A large ratio will potentially reduce the number of steps required to reach the optimum point, but it is likely that the result will be less accurate than a result achieved with a smaller ratio. The smallest allowed ratio is 1.0, meaning that the gradient stepsize will be the incremental value at every step. The default initial expenditure ratio (initiated by a blank field) is 10. Note that this incremental procedure is applicable for the countermeasures with continuous cost functions. Because the program can deal only with one whole stationary source or one whole cell at a time, the stationary source and path-receiver countermeasures have discrete expenditure steps and are independent of the controlled increment expression.

N01Z0P USER'S GUIDE

DATA INPUT

2.11.2 Interpretation of Output

This discussion is included to assist the user in interpreting the output of the optimization process appearing in the primary output. The results should be self-explanatory but there are some subtle points of which the user should be aware. A sample output is shown in Figure 2-18. See lines 367 through 370 of Figure 5-3 for the cards which caused this output, blank cards (lines 368 - 369) are equivalent to zero initial expenditures.

Two identical pages, each containing the program leader, are printed so that the user will be able to tear off his printout and always have a leader page facing upwards.

The adjusted input expenditures are the initial values specified by the user which have been corrected for minimum or maximum expenditure constraints placed on any of the countermeasures.

The total budget, gradient stepsize, and initial maximum expenditure ratio are all user defined variables described in section 2.11.1.

The program will output the current expenditures on each of the countermeasures as well as the associated components of the gradient vector. The resultant noise impact index and expenditure total are also output with each of the steps.

Note that if all the initial expenditures are zero then the resultant Noise Impact Index will be equal to the baseline case Noise Impact Index calculated as a result of the BASE codeword.

If any of the gradient values are negative, the user should suspect erroneous data preparation. A negative value implies that expenditures on this countermeasure will result in increased noise. This type of error may frequently occur for curfew countermeasures where noise energy is transferred into the community from non-existent cells. Since countermeasure-cost functions are assumed to give a monotonically increasing benefit with increasing expenditure, the program will suppress any further gradient calculation on this countermeasure. Note that any negative gradients will usually be spotted following the

OPT -0-0

ADJUSTED INPUT EXPENDITURES:

0.	0.	0.	0.	0.	0.	0.	0.	0.	0.	0.
0.	0.	0.	0.	0.	0.	0.	0.	0.	0.	0.

TOTAL = \$ 0.

TOTAL BUDGET \$ 763440.00
 GRADIENT STEPSIZE \$ 5000.00
 INITIAL MAX. EXPENDITURE RATIO 2.00

STEP	EXPENDITURES (1-10) / (11-20)				GRADIENTS (1-10) / (11-20)			
1	.000000	.000000	.000000	.000000	.000000	.000000	.000000	.000000
	.000000	.000000	.000000	.000000	.000000	.000000	.000000	.000000
	.163656-06	.014896-05	.398593-05	.133711-06	.158506-05	.836956-07	.251732-07	.377252-04
	.634941-08	.121269-05	.484519-06	.000000	.000000	.000000	.000000	.000000
INDEX	.579205	SUM = \$.00				
2	.000000	.000000	.000000	.000000	.000000	.000000	.496240+03	.000000
	.000000	.000000	.000000	.000000	.000000	.000000	.000000	.000000
	.267499-06	.726059-05	.008184-05	.237046-06	.289101-05	.140131-06	.410563-07	.000000
	.160439-07	.153068-05	.504032-06	.000000	.000000	.000000	.000000	.136368-06
INDEX	.393695	SUM = \$	896.24					.495864-06
3	.000000	.598877+04	.000000	.000000	.000000	.000000	.496240+03	.000000
	.000000	.000000	.000000	.000000	.000000	.000000	.000000	.000000
	.081561-07	.136581-06	.186549-05	.310690-06	.345291-05	.183861-06	.488382-07	.000000
	.204641-07	.159009-05	.498023-06	.000000	.000000	.000000	.000000	.633271-07
INDEX	.357493	SUM = \$	6485.01					.217671-06
4	.000000	.598877+04	.000000	.000000	.999350+04	.000000	.496240+03	.000000
	.000000	.000000	.000000	.000000	.000000	.000000	.000000	.000000
	.111322-06	.172798-06	.237247-05	.403381-06	.187350-06	.204736-06	.530671-07	.000000
	.200595-07	.164261-05	.502405-06	.000000	.000000	.000000	.000000	.746765-07
INDEX	.336765	SUM = \$	16478.51					.257644-06
5	.000000	.598877+04	.111300+04	.000000	.999350+04	.000000	.496240+03	.000000
	.000000	.000000	.000000	.000000	.000000	.000000	.000000	.000000
	.004000-07	.124568-06	.000000	.427178-06	.197374-06	.212202-06	.528878-07	.000000
	.259551-07	.165110-05	.502122-06	.000000	.000000	.000000	.000000	.780031-07
INDEX	.331039	SUM = \$	17591.51					.269409-06

Figure 2-18. Sample Printout Due to OPT Codeword

 PATH-RECEIVER BREAKDOWN BY CELL

ZONE	CELL	LND USE	CELL POP.	TOTAL ADV. AFF. NO P-R MODS	REMAINING ADV. AFF. N/ P-R MODS	PER-CENT ADV. AFF. NO P-R MODS	PER-CENT ADV. AFF. N/ P-R MODS	P-R MOD TYPE	P-R MOD EXPENDITURE
1	1	11	142.5	.0	.0	.000	.000	0	.00
2	1	8	7.5	.7	.7	9.287	9.287	0	.00
3	1	5	174.4	.0	.0	.000	.000	0	.00
4	1	1	40.9	.0	.0	.000	.000	0	.00
4	2	1	53.1	.3	.3	.554	.554	0	.00
5	1	1	102.9	35.8	35.8	34.752	34.752	0	.00
5	2	1	81.4	.0	.0	.000	.000	0	.00
6	1	1	55.9	24.2	24.2	43.359	43.359	0	.00
6	2	1	18.4	.0	.0	.000	.000	0	.00
7	1	1	29.6	11.5	11.5	38.779	38.779	0	.00
7	2	1	50.8	.0	.0	.000	.000	0	.00
8	1	1	163.9	69.4	69.4	42.335	42.335	0	.00
8	2	1	22.1	.2	.2	.778	.778	0	.00
9	1	1	102.9	62.6	62.6	60.840	60.840	0	.00
9	2	1	33.7	7.5	7.5	22.215	22.215	0	.00
10	1	1	22.1	12.9	7.4	54.483	33.520	1	23625.00
10	2	1	3.8	.0	.0	.000	.000	0	.00
11	1	1	12.2	2.4	2.4	19.452	19.452	0	.00
11	2	1	9.9	.0	.0	.000	.000	0	.00
12	1	11	142.5	.0	.0	.000	.000	0	.00
13	1	1	87.9	7.9	7.9	9.045	9.045	0	.00
13	2	1	29.6	.0	.0	.000	.000	0	.00
14	1	12	314.0	.0	.0	.000	.000	0	.00
15	1	1	32.4	.7	.7	2.109	2.109	0	.00
15	2	1	33.4	.0	.0	.000	.000	0	.00
15	3	1	271.5	.0	.0	.000	.000	0	.00
16	1	4	144.7	69.8	69.8	48.195	48.195	0	.00
17	1	1	64.7	28.1	28.1	43.382	43.382	0	.00
17	2	1	71.9	23.7	23.7	32.950	32.950	0	.00
18	1	1	41.0	17.1	17.1	40.894	40.894	0	.00
18	2	1	48.7	.0	.0	.000	.000	0	.00
19	1	11	142.5	.0	.0	.000	.000	0	.00
20	1	4	21.5	15.9	15.9	74.000	74.000	0	.00
21	1	1	98.1	85.0	28.1	64.814	28.596	4	167200.00
21	2	1	144.7	45.1	.0	29.770	.000	4	.00
21	3	1	72.9	9.6	.0	11.211	.000	4	.00
22	1	1	156.4	134.9	20.2	84.261	12.916	5	246400.00
22	2	1	155.0	50.6	.0	32.625	.000	5	.00
23	1	11	142.5	69.9	.0	49.083	.000	5	55800.00

Figure 2-18 (Continued)

MCR 76-15

2-63

N9129P USER'S GUIDE
 DATA INPUT

WYLE LABORATORIES

PATH-RECEIVER MODS COST BREAKDOWN

SP-1	SP-2	SP-3	R-1	B-2	RELOCATE	SP-1/R-1	SP-2/R-1	SP-3/R-1	SP-1/R-2	SP-2/R-2	SP-3/R-2
0.	0.	0.	0.	20000.	0.	0.	0.	0.	0.	0.	340000.

PATH-RECEIVER EXPENDITURE = \$ 360000.01
COST OF NEXT P-R MEASURE = \$ 400000.01

STATIONARY SOURCE SUMMARY

SOURCE	CH	TYPE	EXPENSE
1	2	S	30000.00
2	1	S	20000.00

STATIONARY SOURCE EXPENDITURE = \$ 50000.
COST OF NEXT STATIONARY SOURCE MEASURE = \$ 10000.00

FINAL EXPENDITURES:

15000.	12438.	1113.	66996.	29993.	92090.	5000.	496.	0.	9066.
0.	16223.	495025.	0.	0.	0.	0.	0.	0.	0.
									TOTAL = \$ 763440.

FINAL COUNTERMEASURE VARIABLES:

.163605-00	.620000+01	.560000-00	.370205-00	.500192-00	.100000+01	.333732+01	.170000+02	-.000000	.100000+01
-.000000	.100000+01	.495025+06	.000000	.000000	.000000	.000000	.000000	.000000	.000000

IMPACT GRADIENT VECTOR (REDUCTION IN HZ/5):

.114991-07	.000000	.000000	.551709-07	.513676-07	.000000	.179009-07	.000000	-.456201-12	.000000
-.456201-12	.000000	.000000	.000000	.000000	.000000	.000000	.000000	.000000	.000000

GRADIENT MAGNITUDE = .044102-07

COUNTERMEASURE WARNING:	4	5	1	7	13	12	3	10	2	0	6	11	9
SPENDING LIMIT REACHED:	0	0	0	0	0	1	1	1	1	1	1	0	0

Figure 2-18 (Continued)

NOISE IMPACT INDEX = .129561-00
RED. FROM BASELINE = .849604-00
COST/BENEFIT RATIO = .507579+03 \$/PERSON

NOI20P USER'S GUIDE

DATA INPUT

calculations at the initial expenditure level.

Due to inherent inaccuracies in some of the computer system mathematical functions, there may be occasions when a gradient value which should be identically equal to zero, will be output as a number with a very small magnitude. This situation occurred in the example of the San Francisco Study Area presented in Section 5. When the spending limit was reached on the aircraft rerouting countermeasure (all aircraft rerouted), the gradient values for the SAM (Sound Absorbing Material) retrofit and night frequency reduction countermeasures were reduced to zero; but, in some instances, appeared as very small numbers. This causes no problem with the operation of the program, but should be noted and ignored by the user.

When any of the countermeasures reach their spending limits, gradient calculation for them will subsequently be suppressed and will appear to be zero. The gradients for the stationary source and path-receiver countermeasures will be set to zero if it is determined that the next discrete expenditure on that countermeasure would cause the total budget to be exceeded.

Figure 2-19 shows the optimization concept in three dimensions: The NII surface as a function of two countermeasure expenditures with associated constraints. In real application, up to 20 dimensions (20 countermeasures) may be involved. Since the optimization process proceeds along the path of steepest descent, the intermediate results that are obtained are themselves optimum points for their respective expenditure levels. This assumes, of course, that the user has chosen gradient stepsize and initial maximum expenditure ratio values which allow the program to follow closely the actual optimum path. Remember that the selection of these parameters is normally based on achieving the most accurate result at the total target budget level.

Following the completion of the optimization process, the program will output a cell by cell breakdown detailing the sub-optimization of the path-receiver countermeasure options. This output may be deleted at user option by implementing one of the option parameters described earlier (see summary Table 2-9). The breakdown is by cell location; that is, day and night cells occupying the same physical space appear combined. The user determines the option that has been employed by comparing the 'P-R MOD TYPE' number with the option descriptions in Table 2-4. The cost to implement this option is disclosed in the expenditures column.

N01Z0P USER'S GUIDE

DATA INPUT

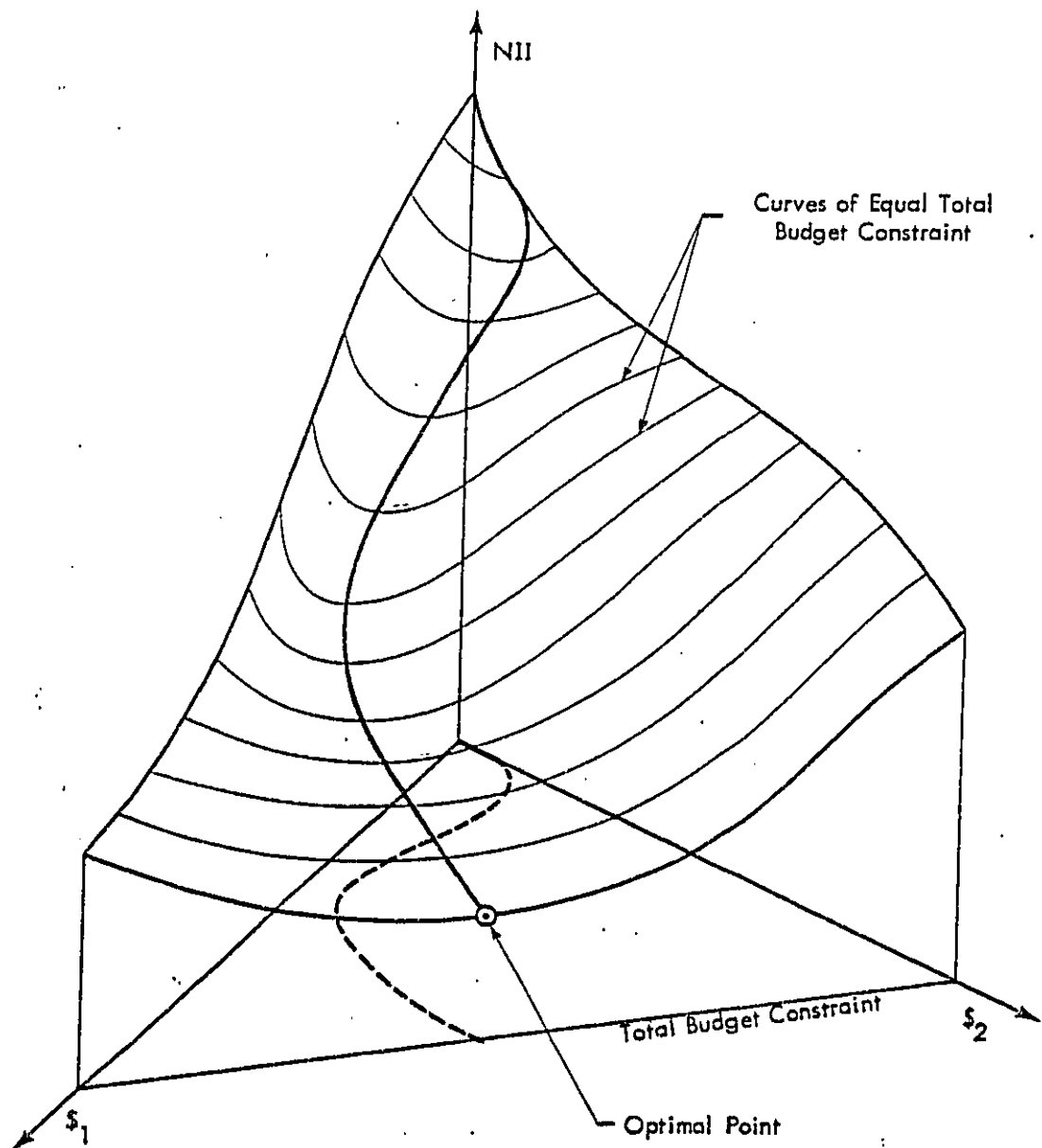

Figure 2-19. Three-Dimensional Illustration of Steepest Descent Path Optimization Method

NOIZOP USER'S GUIDE

DATA INPUT

Table 2-9
Summary of Option Parameters

Codeword	Parameter No. 1	Parameter No. 2
BAR	0 = Printout nonexistent cells 1 = No printout	NA
BASE	NA	NA
CM	NA	NA
CGST	NA	NA
CRIT	Land use type 1-15 0 = All	0 = Upper and lower bound 1 = Lower bound only 2 = Upper bound only 3 = Transfer function shape (0,1,2 = any one or all land use types 3 = always all land use types)
DTA	0 = No echo of input 1 = Echo input	0 = No constant indicators 1 = Input of constant indicators
END	NA	NA
FAC	0 = No printout of factored data 1 = Printout of data	NA
SPT	0 = Breakdown of Path Receiver measures by cell location 1 = No breakdown	0 = Evaluation of true Stationary source gradient only when necessary 1 = always calculate true Stationary Source Gradient
PARE	NA	NA
RANK	NA	NA
STAS	NA	NA

NOI20P USER'S GUIDE

DATA INPUT

In addition to the breakdown by cell, the program outputs a breakdown by option. The 'COST OF NEXT P-R MEASURE' is the next discrete expenditure that would be allocated to the path-receiver countermeasure.

The stationary source summary is a breakdown by source of the measures implemented on each of them. The user relates the type number specified with the listing of the options in Table 2-3.

SUMMARY
OF
OUTPUT

The final page of the output is a summary of the essential results. The final countermeasure variables indicate the relation of the final expenditures to the corresponding noise reduction parameters. You will remember that these noise reduction parameters are either fractions or decibels, depending on the countermeasure type. The final variables for stationary source and path-receiver countermeasures are simply the dollar amounts expended on them.

The countermeasure ranking is an ordered list of the countermeasures by final gradient magnitude. It gives an indication as to the manner in which funds would be allocated beyond the specified total budget. 'Spending limit reached' indicates (with a '1') whether the spending limit was reached on the countermeasure numbered immediately above it (in the ranking row).

The final noise impact index is repeated; if the BASE codeword was invoked, two additional parameters are output. The 'reduction from baseline' is the difference between the initial and final Noise Impact Indices. The cost/benefit ratio is the dollar amount per person in the community that was spent to achieve the reduction in the Noise Impact Index.

2.11.3 Short Form Output

The short form output appearing in the secondary print if so desired and indicated by appropriate controls at the beginning of the input deck (see the beginning of Chapter 2 and Section 4.1 on system control cards) contains abbreviated messages resulting from each of the implemented codewords.

NOIZOP USER'S GUIDE

DATA INPUT

The output for the optimization process indicates the step number, the countermeasure which received the expenditure increase, the current sum of all expenditures, and the resultant Noise Impact Index. Figure 2-20 illustrates a sample short form output.

N91Z9P USER'S GUIDE

DATA INPUT

```

20 JOB DESCRIPTION:
30 TEST DATA FOR SHORT SAMPLE CASE INCLUDIN
40 G STATIONARY SOURCE
50 ---- DTA 1-0
60 DATA ENTERED FOR 3 CELLS
70 ---- CM -0-0
80 8 COUNTERMEASURES DEFINED
90 ---- COST -0-0
100 6 COST FUNCTIONS READ
110 ---- PARE -0-0
120 INPUT OF SOUNDPROOFING DATA COMPLETE
130 ---- STAS -0-0
140 DATA READ FOR 2 STATIONARY SOURCES
150 ---- BAK 1-0
160 DATA READ FOR 2 BARRIERS
170 ---- BASE -0-0
180 BASELINE NII = .588147
190 ---- KANK -0-0
200 MOST OFFENDING SOURCES:
210 1 STATIONARY SOURCE ( 6)
220 2 BUSES ( 3)
230 3 AUTOMOBILES ( 1)
240 4 TRUCK TIRES ( 2)
250 5 RAILROAD ( 4)
260 6 AIRCRAFT ( 5)
270 ---- OPT -0-0
280 STEP CM TOTAL (ALL CM) NII
290 1 0 .00 .588147
300 2 8 10000.00 .498579
310 3 8 20000.00 .411951
320 4 8 40000.00 .371385
330 5 8 60000.00 .338580
340 6 8 160000.00 .292322
350 7 8 260000.01 .246192
360 8 7 280000.00 .236992
370 9 7 290000.01 .232913
380 10 8 340000.01 .208841
390 11 7 410000.00 .204301
400 12 1 420000.00 .202624
410 13 1 430000.01 .200910
420 14 1 440000.01 .199159
430 15 1 450000.00 .197369
440 16 1 460000.01 .195538
450 17 1 470000.01 .193665
460 18 1 480000.00 .191746
470 19 1 490000.00 .189780
480 20 1 500000.00 .187765
490 FINAL EXPENDITURES:
500 $ 90000. $ 0. $ 0. $ 0. $ 0.
510 $ 0. $ 50000. $ 360000. $ 0. $ 0.
520 $ 0. $ 0. $ 0. $ 0. $ 0.
530 $ 0. $ 0. $ 0. $ 0. $ 0.
540 FINAL NII = .187765-00
550 ---- END -0-0

```

Figure 2-20. Sample Short Form Output

N01Z0P USER'S GUIDE

DATA INPUT

2.12 Program Termination

```
END          ANY APPROPRIATE TITLE
|-----|-----|-----|-----|
1      5 7 9
```

The END card is the last codeword to be input, signalling that there are no more codewords coming, and terminates program execution. No option parameters are recognized.

NOIZOP USER'S GUIDE

PROGRAM MESSAGES

CHAPTER 3

DIAGNOSTIC AND ERROR MESSAGES

Incorporated into the program are many error checking routines which monitor the data that is input. This error checking facility is designed to catch errors resulting from data that is improperly formatted as well as those errors in the input data that would cause erroneous results to be computed. The detection of any error causing any of the following messages to be printed results in almost all cases in termination of execution. The messages will appear identically in the main print as well as in the auxiliary short-form file except where noted.

T00 MANY CELLS

The program is designed to handle a maximum of 200 cells. The user must reduce the number of cells he has defined. A reasonable approach is to select a representative sample.

INDEX OUT OF RANGE

The user has specified an illegal option parameter. See Table 2-9 for a listing of meaningful values.

ILLEGAL CODEWORD

Check for codewords spelled incorrectly or placed in the wrong columns. A likely occurrence is that the user did not inform the program that he is using the 'IND' feature of indicator input. See Table 2-9 for a description of the option parameters required for the 'IND' feature.

BLANK CODEWORD CARD ENCOUNTERED

This is a non-fatal error, the user has probably terminated some input with too many blank cards.

NOI20P USER'S GUIDE

PROGRAM MESSAGES

CELLS NOT INPUT IN NUMERICAL ORDER

Short form:
ERROR IN INPUT DATA, CARDS MISSING OR OUT OF ORDER

The cells must be input in a certain numerical sequence; in ascending order by zone number and in ascending order by cell number within each zone (refer to Section 2.1).

ERROR IN INPUT DATA
ZONE AND CELL WERE www AND xxx ON CARD NUMBER i;
DATA FOR ZONE AND CELL yyy AND zzz WAS EXPECTED

Short form:
ERROR IN INPUT DATA, CARDS MISSING OR OUT OF ORDER

Note that the short form message is the same as for the error above. This error will occur when a cell data card type 1 has been omitted from the cell data set. This error can also occur if a card type 2-5 is misplaced and does not immediately follow the associated card type 1 which has the same zone and cell number. In other words, whenever a type 1 card is encountered in the input stream the program expects any subsequent card type 2-5 to contain the same zone and cell numbers that appeared on the card type 1. This expectation process is repeated when a new card type 1 is encountered.

NIGHT CELL FOR CELL NO. xxx IN ZONE NO. yyy OUT OF SEQUENCE

Short form:
NIGHT CELL OUT OF SEQUENCE, ZONE = xxx CELL = yyy

Cell data cards for a night cell must be placed immediately following the associated day version in the input deck (refer to Section 2.1).

'IND' CARD NOT FOUND

This will normally occur if the user has indicated, by placing a non-zero integer in the second option parameter field of the DTA codeword card, that the constant indicator input feature is being employed. Following the blank card that terminates cell data input, the user must place an 'IND' card.

NOISEP USER'S GUIDE

PROGRAM MESSAGES

INVALID LAND USE CODE xx ZONE yyy CELL zzz

Valid land use codes range from 1-15.

INDICATOR NUMBER xxx IS NOT ALLOWED. 20 IS THE MAXIMUM.

The program can handle as many as 20 countermeasure manipulation indicators. Specifying a number greater than 20 while using the 'IND' feature will produce this message.

ERROR IN BARRIER DATA

This error can arise if any of the following data items have been specified:

1. Negative or zero barrier attenuation.
2. Barrier attenuation greater than 24 dB.
3. Barrier number greater than 100.
4. Cell not defined in master data set (see next message).

CELL xxx NOT FOUND - BARRIER yyy

The user has specified a cell in the barrier data which is not defined in the master data set. The xxx is the internal cell number in order of input in the master data set.

COUNTERMEASURE xx MISDEFINED

An unknown countermeasure type code number has been input. See Table 2-5 for a list of allowable type codes.

COUNTERMEASURES DO NOT MATCH COSTS

The user has defined more or less countermeasures than cost functions (refer to Sections 2.2 and 2.3).

CM TYPE 18 OR 20 OUT OF ORDER

NRIZOP USER'S GUIDE

PROGRAM MESSAGES

Stationary source and path-receiver countermeasures must be the final countermeasures to be defined.

NEGATIVE CM PARAMETERS NOT ALLOWED

Countermeasure parameters (variables) must always be positive in the cost functions.

NEGATIVE COSTS DISALLOWED

No negative values in the cost functions are permitted.

COSTS DO NOT MATCH COUNTERMEASURES

More or less cost functions have been input than countermeasures defined. Refer to Sections 2.2 and 2.3.

ERROR IN SOUNDPROOFING DATA

Zeros for decibel or cost specifications are not allowed unless the path-receiver override array has been prepared to allow them (see Section 2.5).

ERROR IN RATIO DATA

The user must take care to specify the first and last zones for which the ratios apply in the correct numerical order. In addition, the user must not specify zones which do not exist.

ERROR IN STATIONARY SOURCE DATA

Three separate types of errors can cause the above message to be printed.

1. More than 20 stationary sources are defined.
2. The sources are not input in numerical sequence.
3. There are unexpected zeros in the cost or decibel fields (See Section 2.6).

N01Z0P USER'S GUIDE

PROGRAM MESSAGES

INITIAL EXPENDITURES EXCEED BUDGET

The user has defined a set of initial expenditures which exceed the total budget he has allowed.

NEGATIVE INITIAL EXPENDITURE, CM xx

All initial expenditures must be non-negative.

ERROR IN TYPE 15 CM N0, xx AFFECTING SOURCE N0, yy

Short form:
ERROR TYPE 15 CM xx SOURCE N0, yy

The program has encountered a situation in which the sum of the countermeasure variables for type 15 countermeasures affecting a source exceeds unity. Refer to Section 2.2.

In addition to the above messages, there are a few messages remaining in the program which were inserted during the debugging phase of development. While these messages should no longer occur, they may have some value to anyone wishing to modify the program to suit his particular needs.

T00 MANY P/R COUNTERMEASURES

The bounds of the D0LPER array (see Appendix C, Common block descriptions) have been exceeded. This may happen if the user has attempted to increase the number of cells the program can contain but has neglected to increase the size of the D0LPER array sufficiently.

T00 MANY CELL LOCATIONS

This error is similar to the message above. The arrays in the /RECPAT/ Common block must be expanded.

T00 MANY SECONDARY CELLS

N01Z0P USER'S GUIDE

PROGRAM MESSAGES

The bounds of the NSEC array have been exceeded or the array was not zeroed before use. The array must be zeroed before every new expenditure scenario is evaluated.

PROGRAM ERROR x. CONTACT PROGRAMMING PERSONNEL.

This error can occur for a large number of reasons, most of which are in the area of arrays being overwritten or misused. If x is 2, 3, or 5, then the error has occurred in subroutines DISBRS, REPCAL, and REBEN, respectively.

N0IZ0P USER'S GUIDE
SPECIAL CONSIDERATIONS

CHAPTER 4
SPECIAL CONSIDERATIONS FOR N0IZ0P APPLICATIONS

4.1 System Control Cards for Execution of N0IZ0P on University
Computing Company Univac 1108.

It is assumed that the user has a basic familiarity with the University Computing Company-1108 Executive System Manual (*) and the FASBAC User's Guide (**) (FASBAC is an interactive teletype accessible timesharing system connected to the 1108 computer). The word 'card' is used here to denote one physical input record. In actual practice, this may indeed be a card, or it may be a line of information if input is from a file, for instance through the use of FASBAC, or through the use of the ADD UCC EXEC control card. In the following instructional control card setups the hypothetical University Computing Company-1108 user account number XXXYYY is used, and it is assumed that the primary printed output is to be routed to a line printer with the site code 2215 (every remote batch station is identified to the UCC system by a unique site code). Furthermore, it is assumed that the user wishes to direct the secondary output to his FASBAC account BZZZVVVO where this output will be stored as a 'common' file with the name N0ISEC. Also, an immediately executable copy of the N0IZ0P program is assumed to be stored in the file N0IZ0P/UCCABS (this is also called a 'pseudo-processor'). A typical card deck setup would look like this (the @-sign is a 7-8 multipunch on cards):

(*) University Computing Company, 'Univac 1108 Executive System Programmer's Reference Manual,' UCC Publication 3025, June 1974.

(**) University Computing Company, 'FASBAC User's Guide,' UCC Publication 3010, 07-01-75, updated June 2, 1975.

N0IZ0P USER'S GUIDE

SPECIAL CONSIDERATIONS

```
  @ RUN,D INTID,XXXYYY,3,100                                BZZZVVVO
  @ MSG PLEASE NOTIFY JOHN DOE, EXTENSION 345
  @ DIR 7=1/37(N0ISEC)
  @ FCL AUXPR,AUXPR
  PRINTER 8,ALTERNATE FILE 1
  @ N0IZ0P XQT
```

Input data (described in previous sections of this report)

@@

The RUN card says that the run is at normal priority ('D'), is identified by 'INTID' (this field is often used for the user's internal accounting; it will appear on University Computing Company's monthly billing sheet), the user's account number is XXXYYY, he is allowing for up to 3 minutes of central processing time, and up to 100 pages of printed output. He also identifies with BZZZVVVO his FASBAC account number, with the B in column 45.

Any number of MSG cards can be used to transmit messages to appear on the primary printed output.

The DIR card says direct the secondary printed output ('7') to FASBAC which has the site code 1/37, and store it there in the common file N0ISEC. The FCL card and the card that follows it sets up FORTRAN logical unit 8 as the secondary printed output.

N0IZ0P XQT actually loads the computer program into core and starts executing it. This card is followed by the input data cards. The card deck is ended by an end-of-file card which consists of two @-characters. This last card is not required if input is from a FASBAC file.

If the user now wishes to look at his secondary printed output in FASBAC after his run has been made, he would log in and could then obtain a printed copy by giving the command

TPC N0ISEC

N0IZ0P USER'S GUIDE
SPECIAL CONSIDERATIONS

It is recommended however, that the file N0ISEC be stripped of undesirable and confusing lines and characters before typing out the hard copy by the use of a command file here called AUX, looking like this:

```
TSP
LABEL 1
N
EOF 3
:IF/C2,2 /$/: JUMP 2
DELETE %L,%L
JUMP 1
LABEL 2
C/NP/W*/C1,2 /***//
JUMP 1
LABEL 3
TYPE
```

With this command file AUX in existence, the commands after logging in would be like this:

```
OLD N0ISEC C0
USE AUX
```

After a short time delay, the secondary print will be typed out. To avoid unnecessary storage charges, N0ISEC should be deleted after a hard copy has been obtained by commanding:

```
UNSAVE N0ISEC C0
```

For the next example, let us assume that the file N0IZ0P/PR0GS contains both the symbolic and object modules of all the routines that collectively make up the N0IZ0P program. Let us further assume that the main program is also called N0IZ0P. Also, this time, we do not wish to generate a secondary print. A typical card deck setup would then look like this:

```
@ RUN,D INTID,XXXYYY,3,100
@ MSG N0 SECONDARY PRINT
@ XGT CUR
FSTIN N0IZ0P/PR0GS
@N XGT N0IZ0P
.
.
.
data cards
.
.
.
@@
```

N0IZ0P USER'S GUIDE
SPECIAL CONSIDERATIONS

The XQT CUR commands the execution of the 'Complex Utility Routines', in this case loading the Fastrand file N0IZ0P/PROGS into the user accessible area of the magnetic storage drum, called the 'Program Complex File' (PCF). The next card, XQT N0IZ0P, directs that the object module called N0IZ0P/C0DE (which would have been generated from a symbolic element called N0IZ0P, i.e., the FORTRAN deck of the main program) be treated as a main program, assembling all the subroutines that it requires, loading it into core, and starting execution.

For the next example, let us assume that we wish to generate a secondary print in FASBAC, to use the absolute element N0IZ0P/UCCABS for executing the program, and that the Fastrand file SP0KAN/L0W contains card images of all the data we wish to supply to N0IZ0P except the first card. Then, the deck would be set up in the following manner:

```
  @ RUN,D INTID,XXXYYY,3,100                BZZZVVVO
  @ MSG INPUT FROM SP0KAN/L0W
  @ DIR 7=1/37(N0ISEC)
  @ FCL AUXPR,AUXPR
  PRINTER 8,ALTERNATE FILE 1
  @ XQT CUR
  FSTIN SP0KAN/L0W
  @ N0IZ0P XQT
  T 8
  @I ADD SP0DL0
  @@
```

The ADD command with the 'I'-option is transparent, i.e., it will not be echoed on the primary print like all the other control cards, but simply gives the instruction to add the symbolic card images contained in the PCF element SP0DL0 as if they all had been put into the run deck at this point. SP0DL0 would have been an element of the Fastrand file SP0KAN/L0W which was loaded into the PCF earlier by the FSTIN command after XQT CUR.

N6126P USER'S GUIDE
SPECIAL CONSIDERATIONS

4.2 Two Dimensions with Type 15 Countermeasures

Section 2.2 gives a general description of the type 15 countermeasure, and also a short example of how it can be used to simulate a two-dimensional cost function. Two dimensional means that the effect (noise reduction) depends on two expenditures. More details and a different application are discussed here.

The mathematically minded reader will notice that there is a restriction imposed on the form the two-dimensional cost function can take; it must be a product of functions, each depending only on one expenditure:

$$F(s,t) = f(s)g(t) \quad (4-1)$$

where F is the two-dimensional function, s and t are expenditures on two type 15 countermeasures, and f and g are one-dimensional functions of s and t , respectively.

A special problem arises when $f(s)$ and $g(t)$ are originally given in terms of 'decibels versus cost'. Remembering that the type 15 countermeasure accepts only information of the kind 'fractional application versus cost' (i.e., apply a constant noise reduction device to a fraction of a fleet of vehicles), a transformation of scale must be performed before the cost function is suitable for input to the computer program.

Let the range of f be from 0 to f_{max} . If we wanted to implement the 'fractional application' kind of countermeasure, then the noise reduction (NR) as a function of the fraction treated (a) would be:

$$NR(a, f_{max}) = -10 * \log\{[a + (1-a) * 10^{**}(f_{max}/10)] * 10^{**}(-f_{max}/10)\} \quad (4-2)$$

where a single asterisk denotes multiplication, and a double asterisk denotes 'raise to the power'.

However, if we want to implement the 'decibel versus cost' kind of countermeasure, f (the actual decibel noise reduction) is given directly as a function of cost s , whereas the type 15 countermeasure accepts only fractional application a versus cost s , a must therefore be calculated for any given $f(s)$ from the inverted equation (4-2), setting NR equal to $f(s)$:

N81Z8P USER'S GUIDE
SPECIAL CONSIDERATIONS

$$a = \frac{10^{(f_{\max}/10)} \cdot [1 - 10^{(-f(s)/10)}]}{10^{(f_{\max}/10)} - 1} \quad (4-3)$$

As an illustration, Figure 4-1 shows a as a function of s if $f(s)$ is linear. A practical example is given in Figure 4-2. There, $f(s)$ is given as a piecewise linear function. $a(f(s))$ would consist of pieces of curved functions which, for purposes of input to N81Z8P, are again approximated by linear segments.

Figure 4-2 also indicates on the right-most scale another feature of the simulation of two-dimensional cost functions. The example in Section 2.2, type 15, mentions that the fractions of noise energy contributed by each partial fleet must be known for the baseline case. In the example used in Figure 4-2, the total fleet is the fleet of all trucks; the partial fleet under consideration is the fleet of 'existing' or 'old' trucks, which, say, make up 53.1 percent of the fleet, and contribute 56.4 percent of the noise energy (details of how this number is obtained are not discussed here). The other partial fleet ('new' trucks) therefore contributes $100 - 56.4 = 43.6$ percent of the noise energy. The feasible range for the old trucks countermeasure would therefore be 0, to 0.564; this is shown on the right-most scale of Figure 4-2.

Two type 15 countermeasures would be defined, both to apply to the source 'trucks' as a whole, but each dealing with a partial fleet. How the cost functions would be transformed has been shown above for one countermeasure.

It is easily seen that this concept can be generalized to three- and more-dimensional cost functions as long as they can be written as products of one-dimensional cost functions. Also, note that 'decibel versus cost' and 'fractional application versus cost' can be mixed.

NOISE USER'S GUIDE
SPECIAL CONSIDERATIONS

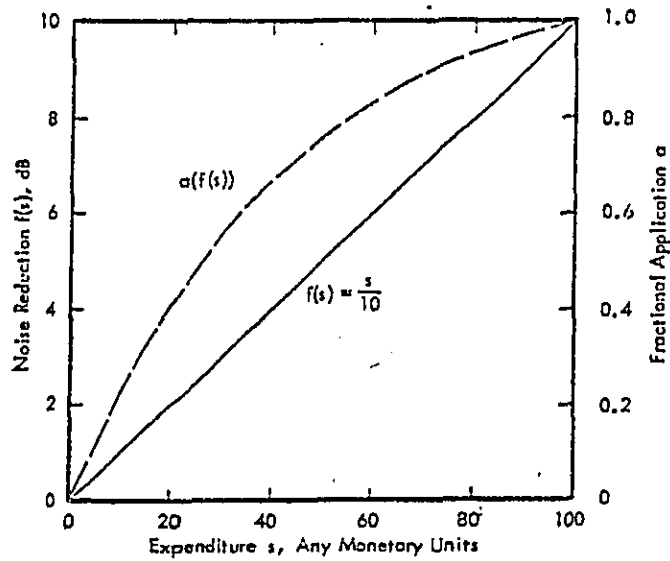

Figure 4-1. Illustration of Scale Transformation for Type 15 Countermeasure

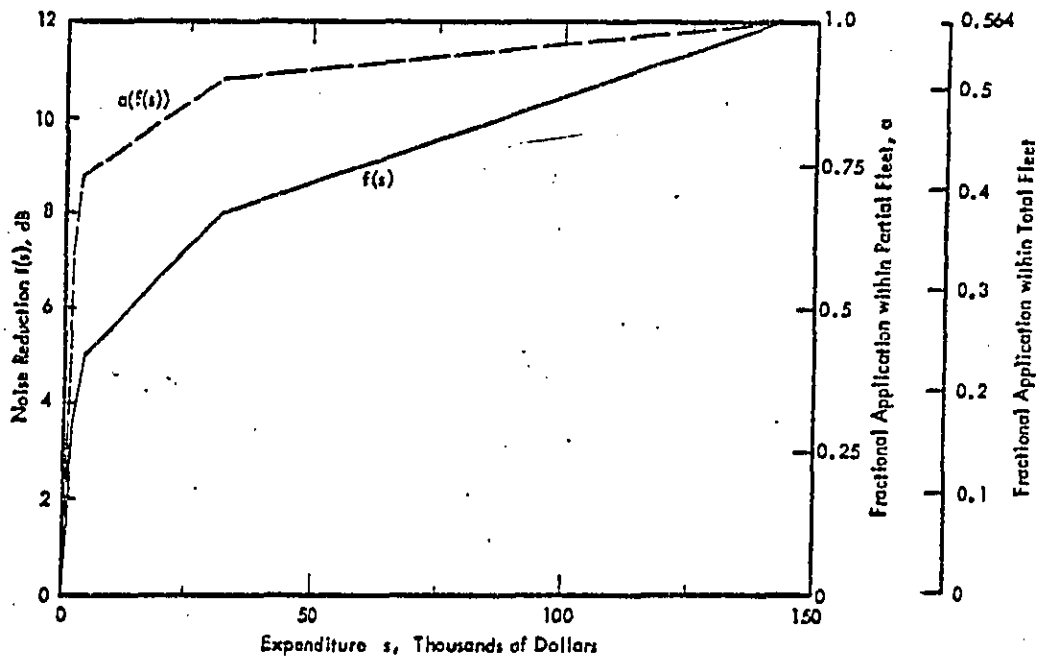

Figure 4-2. Practical Example of Scale Transformation for Type 15 Countermeasure

NOIZOP USER'S GUIDE

EXAMPLES

CHAPTER 5

EXAMPLES OF NOIZOP DATA INPUT

5.1 A Simple Demonstration Case

This example is a purely hypothetical demonstration case, i.e., it is not based on any real data. Particular numbers were chosen to test and demonstrate many capabilities of NOIZOP 2.1. The input stream is shown in Figure 5-1, the resulting output in Figure 5-2. The following chart relates input stream lines of Figure 5-1 to the page number where the resulting output may be found.

<u>LINES IN INPUT STREAM</u>	<u>OUTPUT CREATED PAGE NUMBER(S)</u>	<u>REFER TO SECTION NUMBER</u>
1	5-4	2.0
2-3	all	2.0
4-23	5-6	2.1
24-41	5-7	2.2
42-67	5-8	2.3
68-74	5-9	2.5
75-80	5-10	2.6
81-87	5-11	2.4
88	5-11	2.9
89	5-12	2.10
90-92	5-13 to 5-17	2.11.1
93	5-17	2.12

REST COPY AVAILABLE

N0128P USER'S GUIDE

EXAMPLES

```

000001      1 8
000002      SHUNT EXAMPLE CASE
000003      TEST DATA FOR SHUNT SAMPLE CASE INCLUDING STATIONARY SOURCE
000004      DTA 1 THREE CELL EXAMPLE CASE
000005      AUTOMOBILES
000006      TRUCK TIRES
000007      BUSES
000008      RAILROAD
000009      AIRCRAFT
000010      STATIONARY SOURCE
000011      REDOUTED AIRCRAFT
000012
000013      1 1 1 1 1 0
000014      1 1 1 100. 500. 100. 45. 1.
000015      1 1 2 80. 55. 90. 92. 85. 48.
000016      1 1 4 3800.210200.210200. 1.
000017      1101 1 200. 500. 100. 40. 1.
000018      1101 2 55. 50. 45. 52. 80. 48.
000019      1101 4 3800.210200.208200. 1.
000020      2 1 1 400. 800. 200. 55. 5.
000021      2 1 2 70. 68. 72. 85. 55. 85. 60.
000022      2 1 4 3800.210200.210200. 2.
000023
000024      CM COUNTERMEASURES FOR EXAMPLE CASE
000025      MUFFLERS ON CARS
000026      10 1 2
000027      QUIET TRUCK TIRES
000028      15 2 3
000029      LEV REDUCTION OF BUSES
000030      12 3
000031      AIRCRAFT REDOUTING
000032      1 5 7
000033      NIGHT FLIGHT CUMFER OF AIRCRAFT
000034      3 5 7
000035      SWITCHING NIGHT RAILROAD ACTIVITY TO DAY
000036      5 4 1
000037      STATIONARY SOURCE REDUCTION
000038      18 8 4
000039      BARRIERS AND SOUNDPROOFING
000040      20
000041
000042      COST SAMPLE NUMBERS TO SIMULATE COSTS
000043      COSTS TO INSTALL MUFFLERS ON CARS
000044      0. 1.
000045      0. 1.
000046      0. 100.
000047      COSTS FOR QUIET TRUCK TIRES
000048      0. 1.
000049      0. 1.
000050      0. 200.
000051      COSTS FOR QUIETING BUSES
000052      0. 5.
000053      0. 5.
000054      0. 500.
000055      REDOUTING COSTS
000056      0. 1.
000057      0. 1.
000058      0. 5000.

```

Figure 5-1. Input Stream for Simple Demonstration Case. The left-most column is not part of the input data; it provides a line count for this figure.

N9128P USER'S GUIDE

EXAMPLES

```

000059 NIGHT FLIGHT CURFEN COSTS
000060 0. 1.
000061 0. 1.
000062 0. 1000.
000063 RAILROAD CURFEN SWITCHING COSTS
000064 0. 1.
000065 0. 1.
000066 0. 200.
000067
000068 PATH-RECEIVER INPUT
000069 TEST VALUES FOR SOUNDPROOFING
000070 1 1 1 1 1 1 1 1 1 1 1
000071 5 10 15 2. 3.
000072 1. 2. 3.
000073 10 20 30 4. 5.
000074 2. 4. 5.
000075 STAS STATIONARY SOURCE INPUT
000076 STATIONARY SOURCE SAMPLE INPUT
000077 1 1 1 1 1 1
000078 1 3. 5. 20. 30. 40. 100.
000079 2 6. 8. 20. 30. 40. 100.
000080
000081 BAR 1 SAMPLE MANNERS FOR EXAMPLE
000082 BARRIER DEFINITION WITH NO SECONDARY CELLS
000083 1. 1. 1. .65 0. 1.
000084 1. 1. 1. .85 0. 1.
000085 1 20. 40. 1 1 5. 10.
000086 2 10. 20. 2 1 5. 10.
000087
000088 BASE BASELINE EVALUATION
000089 KARR ILLUSTRATIVE SOURCE LEVELS ONLY
000090 OPT 500X OPT RUN
000091
000092 .5 10. 1.
000093 END

```

Figure 5-1. (Continued)

N8128P USER'S GUIDE

EXAMPLES

```

20 JOB DESCRIPTION:
30 TEST DATA FOR SHORT SAMPLE CASE INCLUDIN
40 G STATIONARY SOURCE
50 ---- DTA 1=0
60 DATA ENTERED FOR 3 CELLS
70 ---- CM =0=0
80 8 COUNTERMEASURES DEFINED
90 ---- COST =0=0
100 6 COST FUNCTIONS READ
110 ---- PARE =0=0
120 INPUT OF SOUNDPROOFING DATA COMPLETE
130 ---- STAS =0=0
140 DATA READ FOR 2 STATIONARY SOURCES
150 ---- BAK 1=0
160 DATA READ FOR 2 BARRIERS
170 ---- BASE =0=0
180 BASELINE NII = .588147
190 ---- RANK =0=0
200 MOST OFFENDING SOURCES:
210 1 STATIONARY SOURCE ( 6)
220 2 BUSES ( 3)
230 3 AUTOMOBILES ( 1)
240 4 TRUCK TIRES ( 2)
250 5 RAILROAD ( 4)
260 6 AIRCRAFT ( 5)
270 ---- OPT =0=0
280 STEP CM TOTAL (ALL CM) NII
290 1 0 .00 .588147
300 2 8 10000.00 .498579
310 3 8 20000.00 .411951
320 4 8 40000.00 .371385
330 5 8 60000.00 .338560
340 6 8 100000.00 .292322
350 7 8 200000.01 .246192
360 8 7 280000.00 .236992
370 9 7 290000.01 .232913
380 10 8 340000.01 .208841
390 11 7 410000.00 .204301
400 12 1 420000.00 .202624
410 13 1 430000.01 .200910
420 14 1 440000.01 .199159
430 15 1 450000.00 .197369
440 16 1 460000.01 .195538
450 17 1 470000.01 .193665
460 18 1 480000.00 .191746
470 19 1 490000.00 .189780
480 20 1 500000.00 .187765
490 FINAL EXPENDITURES:
500 $ 90000. $ 0. $ 0. $ 0. $ 0.
510 $ 0. $ 50000. $ 360000. $ 0. $ 0.
520 $ 0. $ 0. $ 0. $ 0. $ 0.
530 $ 0. $ 0. $ 0. $ 0. $ 0.
540 FINAL NII = .187765-00
550 ---- END =0=0

```

Figure 5-2. Short Form Output of Simple Demonstration Case. The left-most column provides a line count which does not usually appear.

```
.....  
COMMUNITY NOISE OPTIMIZATION  
PROGRAM  
NOIZOP VERSION 2.1  
-----  
WYLE LABORATORIES  
.....
```

```
.....  
TITLE: DATA SET  
JOB DESCRIPTION:  
.....
```

```
SHORT EXAMPLE CASE  
TEST DATA FOR SHORT SAMPLE CASE INCLUDING STATIONARY SOURCE
```

 TITLE- DATA SET:
 JOB DESCRIPTION:

SHOW EXAMPLE CASE
 TEST DATA FOR SHORT SAMPLE CASE INCLUDING STATIONARY SOURCE

 CM -0-0

COUNTERMEASURES FOR EXAMPLE CASE

***** MUFFLERS ON CARS COUNTERMEASURE 1 TYPE 10 'PANT INT' APPLIES TO: AUTOMOBILES	INDICATOR NO. 2
***** QUIET TRUCK TIRES COUNTERMEASURE 2 TYPE 15 'EXCL INT' APPLIES TO: TRUCK TIRES	INDICATOR NO. 3
***** LED REDUCTION OF BUSES COUNTERMEASURE 3 TYPE 12 'DR RED' APPLIES TO: BUSES	INDICATOR NO. -0
***** AIRCRAFT REROUTING COUNTERMEASURE 4 TYPE 1 'RED FREQ' APPLIES TO: AIRCRAFT REROUTED AIRCRAFT	INDICATOR NO. -0 -0
***** NIGHT FLIGHT CURFEM OF AIRCRAFT COUNTERMEASURE 5 TYPE 3 'NITE RED' APPLIES TO: AIRCRAFT REROUTED AIRCRAFT	INDICATOR NO. -0 -0
***** SWITCHING NIGHT RAILROAD ACTIVITY TO DAY COUNTERMEASURE 6 TYPE 5 'CURFEM' APPLIES TO: RAILROAD	INDICATOR NO. 1
***** STATIONARY SOURCE REDUCTION COUNTERMEASURE 7 TYPE 10 'STA SORS' APPLIES TO: STATIONARY SOURCE	INDICATOR NO. 4
***** BARRIERS AND SOUNDPROOFING COUNTERMEASURE 0 TYPE 20 'P-R MUD' APPLIES TO: ALL SOURCES	INDICATOR NO. -0

MCR 76+15

5-8

 TITLE- DATA SET:
 JOB DESCRIPTION:

SHORT EXAMPLE CASE
 TEST DATA FOR SHORT SAMPLE CASE INCLUDING STATIONARY SOURCE

*****		SAMPLE NUMBERS TO SIMULATE COSTS								
*****		*****								
----- COSTS TO INSTALL MUFFLERS ON CARS										
FEASIBLE RANGE OF CM VARIABLE:	.000 TO	1.000								
NOISE RED PARAMETER:	.00	1.00	1.00	-.00	-.00	-.00	-.00	-.00	-.00	-.00
CORRESPONDING COSTS:	.00	100.00	-.00	-.00	-.00	-.00	-.00	-.00	-.00	-.00
----- COSTS FOR QUIET TRUCK TIRES										
FEASIBLE RANGE OF CM VARIABLE:	.000 TO	1.000								
NOISE RED PARAMETER:	.00	1.00	1.00	-.00	-.00	-.00	-.00	-.00	-.00	-.00
CORRESPONDING COSTS:	.00	200.00	-.00	-.00	-.00	-.00	-.00	-.00	-.00	-.00
----- COSTS FOR QUIETING BUSES										
FEASIBLE RANGE OF CM VARIABLE:	.000 TO	5.000								
NOISE RED PARAMETER:	.00	5.00	5.00	-.00	-.00	-.00	-.00	-.00	-.00	-.00
CORRESPONDING COSTS:	.00	500.00	-.00	-.00	-.00	-.00	-.00	-.00	-.00	-.00
----- HEAVY TRUCK CURFEN COSTS										
FEASIBLE RANGE OF CM VARIABLE:	.000 TO	1.000								
NOISE RED PARAMETER:	.00	1.00	1.00	-.00	-.00	-.00	-.00	-.00	-.00	-.00
CORRESPONDING COSTS:	.00	5000.00	-.00	-.00	-.00	-.00	-.00	-.00	-.00	-.00
----- NIGHT FLIGHT CURFEN COSTS										
FEASIBLE RANGE OF CM VARIABLE:	.000 TO	1.000								
NOISE RED PARAMETER:	.00	1.00	1.00	-.00	-.00	-.00	-.00	-.00	-.00	-.00
CORRESPONDING COSTS:	.00	1000.00	-.00	-.00	-.00	-.00	-.00	-.00	-.00	-.00
----- RAILROAD CURFEN SWITCHING COSTS										
FEASIBLE RANGE OF CM VARIABLE:	.000 TO	1.000								
NOISE RED PARAMETER:	.00	1.00	1.00	-.00	-.00	-.00	-.00	-.00	-.00	-.00
CORRESPONDING COSTS:	.00	200.00	-.00	-.00	-.00	-.00	-.00	-.00	-.00	-.00

SUMMARY OF ALLOWED COST RANGES (\$000'S):

COUNTERMEASURE NUMBER	RANGE
1	\$.00 TO \$ 100.00
2	\$.00 TO \$ 200.00
3	\$.00 TO \$ 500.00
4	\$.00 TO \$ 5000.00
5	\$.00 TO \$ 1000.00
6	\$.00 TO \$ 200.00

NOISEP USER'S GUIDE
 EXAMPLES

WYLE LABORATORIES

```

*****
TITLE- DATA SET: SHUNT EXAMPLE CASE
JOB DESCRIPTION: TEST DATA FOR SHUNT SAMPLE CASE INCLUDING STATIONARY SOURCE
*****

```

```

*****
PARE -0-0 PATH-RECEIVER INPUT
*****

```

```

----- TEST VALUES FOR SOUNDPROOFING
P/R MOD OVERRIDE ARRAY:
| | | | | | | | | |
RESIDENTIAL SOUNDPROOFING AND COST FACTORS ($/SQ FT)
  5 DB   10 DB   15 DB
  1.00   2.00   3.00
COMMERCIAL SOUNDPROOFING AND COST FACTORS ($/SQ FT)
  10 DB   20 DB   30 DB
  2.00   4.00   5.00

```

MCR 76-15

5-10

WYLE LABORATORIES

```

*****
TITLE- DATA SET:      SHORT EXAMPLE CASE
JOB DESCRIPTION:     TEST DATA FOR SHORT SAMPLE CASE INCLUDING STATIONARY SOURCE
*****

```

```

*****
STAS -0-0           STATIONARY SOURCE INPUT
*****

```

```

----- STATIONARY SOURCE SAMPLE INPUT

```

```

STATIONARY SOURCE OVERRIDE ARRAYS

```

STATIONARY SOURCES-

SOURCE	MIN.		MAX.		COSTS IN THOUSANDS		ELIM. SOURCE
	HED.	HED.	HED.	HED.	HIGHT	HIGHT	
1	3.	5.	20.00	30.00	40.00	100.00	
2	6.	8.	20.00	30.00	40.00	100.00	

N0120P USER'S GUIDE
 EXAMPLES

```

*****
TITLE- DATA SET:      SHORT EXAMPLE CASE
JOB DESCRIPTION:      TEST DATA FOR SHORT SAMPLE CASE INCLUDING STATIONARY SOURCE
*****

```

```

*****
BAR 1-0              SAMPLE BARRIERS FOR EXAMPLE
*****

```

----- BARRIER DEFINITION WITH NO SECONDARY CELLS

BARRIER EFFECTIVENESS RATIOS

	LOW	HIGH
1 AUTOMOBILES	1.00	1.00
2 TRUCK TRAILERS	1.00	1.00
3 BUSES	1.00	1.00
4 RAILROAD	.85	.85
5 STATIONARY SOURCE	1.00	1.00

ANBR *	COSTS (-\$1000'S)		PRIMARY CELL		SECONDARY CELLS -->										
	HT 1	HT 2 *	ID	DB1	DB2 *	ID	DB1	DB2 *	ID	DB1	DB2 *	ID	DB1	DB2 *	
A 1 *	20.0	40.0 *	1	1	5.0	10.0 *	-0	-0	-0	-0	-0	-0	-0	-0	-0
A 2 *	10.0	20.0 *	2	1	5.0	10.0 *	-0	-0	-0	-0	-0	-0	-0	-0	-0

```

*****
TITLE- DATA SET:      SHORT EXAMPLE CASE
JOB DESCRIPTION:      TEST DATA FOR SHORT SAMPLE CASE INCLUDING STATIONARY SOURCE
*****

```

```

*****
BASE 0-0-0          BASELINE EVALUATION
*****

```

FOR AN AVE POPULATION OF 305. PERSONS, THE BASELINE NOISE IMPACT INDEX IS .586187

TITLE- DATA SET:
JOB DESCRIPTION:

SHORT EXAMPLE CASE
TEST DATA FOR SHORT SAMPLE CASE INCLUDING STATIONARY SOURCE

RANK -0-0

ILLUSTRATIVE SOURCE LEVELS ONLY

POPULATION WEIGHTED AVE INDICES FOR SOURCE RANKING:						SOURCES (1-10) / (11-20)			
.129882	.067881	.171503	.030709	.013390	.175102	.000000	.000000	.000000	.000000
.000000	.000000	.000000	.000000	.000000	.000000	.000000	.000000	.000000	.000000

FRACTIONAL CONTRIBUTION TO NOISE IMPACT INDEX:						SOURCES (1-10) / (11-20)			
.220832	.114715	.291599	.052213	.022766	.297454	.000000	.000000	.000000	.000000
.000000	.000000	.000000	.000000	.000000	.000000	.000000	.000000	.000000	.000000

MOST OFFENDING SOURCES:	SOURCE NO.
1 STATIONARY SOURCE	(6)
2 BUSES	(3)
3 AUTOMOBILES	(1)
4 TRUCK TIRES	(2)
5 RAILROAD	(4)
6 AIRCRAFT	(5)

 TITLE- DATA SET: SHORT EXAMPLE CASE
 JOB DESCRIPTION: TEST DATA FOR SHORT SAMPLE CASE INCLUDING STATIONARY SOURCE

 DP1 -0-0 500K DP1 RUN

ADJUSTED INPUT EXPENDITURES:

0.	0.	0.	0.	0.	0.	0.	0.	0.	0.	0.
0.	0.	0.	0.	0.	0.	0.	0.	0.	0.	0.
TOTAL = \$										
0.										

TOTAL BUDGET = \$ 50000.00
 GRADIENT STEPSIZE = \$ 10000.00
 INITIAL MAX. EXPENDITURE RATIO = 1.00

STEP	EXPENDITURES (1-10) / (11-20) / GRADIENTS (1-10) / (11-20)				
1	.000000	.000000	.000000	.000000	.000000
	.000000	.000000	.000000	.000000	.000000
	.237716-06	.526954-07	.747638-07	.695505-09	.224255-08
	.000000	.000000	.000000	.000000	.000000
INDEX =	.588147	SUM = \$.00		
2	.000000	.000000	.000000	.000000	.000000
	.000000	.000000	.000000	.000000	.000000
	.232051-06	.514644-07	.723662-07	.966716-09	.224255-08
	.000000	.000000	.000000	.000000	.000000
INDEX =	.049579	SUM = \$	10000.00		
3	.000000	.000000	.000000	.000000	.000000
	.000000	.000000	.000000	.000000	.000000
	.220592-06	.455692-07	.675270-07	.174344-08	.224255-08
	.000000	.000000	.000000	.000000	.000000
INDEX =	.411951	SUM = \$	20000.00		
4	.000000	.000000	.000000	.000000	.000000
	.000000	.000000	.000000	.000000	.000000
	.212416-06	.475252-07	.675275-07	.264401-08	.543112-08
	.000000	.000000	.000000	.000000	.000000
INDEX =	.371385	SUM = \$	40000.00		
5	.000000	.000000	.000000	.000000	.000000
	.000000	.000000	.000000	.000000	.000000
	.148505-06	.456080-07	.675275-07	.443883-08	.118526-07
	.000000	.000000	.000000	.000000	.000000
INDEX =	.338580	SUM = \$	60000.00		

NB129P USER'S GUIDE

EXAMPLES

MCR 76-15

5-13

WYLE LABORATORIES

BEST COPY AVAILABLE

STEP	EXPENDITURES (I-10) / (II-20) / GRANTIES (I-10) / (II-20)									
6	.000000	.000000	.000000	.000000	.000000	.000000	.000000	.160000+06	.000000	.000000
	.000000	.000000	.000000	.000000	.000000	.000000	.000000	.000000	.000000	.000000
	.198504-06	.456075-07	.675270-07	.443854-04	.118524-07	.000000	.460000-06	.261301-06	.000000	.000000
	.000000	.000000	.000000	.000000	.000000	.000000	.000000	.000000	.000000	.000000
INDEX#	.292322	SUM# \$		160000.00						
7	.000000	.000000	.000000	.000000	.000000	.000000	.000000	.260000+06	.000000	.000000
	.000000	.000000	.000000	.000000	.000000	.000000	.000000	.000000	.000000	.000000
	.198504-06	.456075-07	.675270-07	.443854-04	.118524-07	.000000	.460000-06	.373514-06	.000000	.000000
	.000000	.000000	.000000	.000000	.000000	.000000	.000000	.000000	.000000	.000000
INDEX#	.266192	SUM# \$		260000.01						
8	.000000	.000000	.000000	.000000	.000000	.000000	.200000+05	.260000+06	.000000	.000000
	.000000	.000000	.000000	.000000	.000000	.000000	.000000	.000000	.000000	.000000
	.204915-06	.470901-07	.675275-07	.520766-08	.141811-07	.000000	.407920-06	.281513-06	.000000	.000000
	.000000	.000000	.000000	.000000	.000000	.000000	.000000	.000000	.000000	.000000
INDEX#	.236992	SUM# \$		200000.00						
9	.000000	.000000	.000000	.000000	.000000	.000000	.300000+05	.260000+06	.000000	.000000
	.000000	.000000	.000000	.000000	.000000	.000000	.000000	.000000	.000000	.000000
	.216137-06	.478941-07	.675270-07	.562666-08	.152950-07	.000000	.226447-06	.240721-06	.000000	.000000
	.000000	.000000	.000000	.000000	.000000	.000000	.000000	.000000	.000000	.000000
INDEX#	.232413	SUM# \$		290000.01						
10	.000000	.000000	.000000	.000000	.000000	.000000	.160000+05	.360000+06	.000000	.000000
	.000000	.000000	.000000	.000000	.000000	.000000	.000000	.000000	.000000	.000000
	.158465-06	.403078-07	.675271-07	.117815-08	.000000	.000000	.226497-06	.000000	.000000	.000000
	.000000	.000000	.000000	.000000	.000000	.000000	.000000	.000000	.000000	.000000
INDEX#	.208041	SUM# \$		340000.01						
11	.000000	.000000	.000000	.000000	.000000	.000000	.500000+05	.360000+06	.000000	.000000
	.000000	.000000	.000000	.000000	.000000	.000000	.000000	.000000	.000000	.000000
	.167747-06	.426665-07	.714445-07	.124027-08	.000000	.000000	.646758-07	.000000	.000000	.000000
	.000000	.000000	.000000	.000000	.000000	.000000	.000000	.000000	.000000	.000000
INDEX#	.204301	SUM# \$		410000.00						
12	.100000+05	.000000	.000000	.000000	.000000	.000000	.500000+05	.360000+06	.000000	.000000
	.000000	.000000	.000000	.000000	.000000	.000000	.000000	.000000	.000000	.000000
	.171336-06	.435717-07	.730044-07	.127411-08	.000000	.000000	.662107-07	.000000	.000000	.000000
	.000000	.000000	.000000	.000000	.000000	.000000	.000000	.000000	.000000	.000000
INDEX#	.202624	SUM# \$		420000.00						
13	.200000+05	.000000	.000000	.000000	.000000	.000000	.500000+05	.360000+06	.000000	.000000
	.000000	.000000	.000000	.000000	.000000	.000000	.000000	.000000	.000000	.000000
	.175086-06	.445175-07	.745916-07	.130241-08	.226110-12	.000000	.678210-07	.000000	.000000	.000000
	.000000	.000000	.000000	.000000	.000000	.000000	.000000	.000000	.000000	.000000
INDEX#	.200910	SUM# \$		450000.01						
14	.300000+05	.000000	.000000	.000000	.000000	.000000	.500000+05	.360000+06	.000000	.000000
	.000000	.000000	.000000	.000000	.000000	.000000	.000000	.000000	.000000	.000000
	.170998-06	.453029-07	.762472-07	.132801-08	.738326-12	.000000	.695134-07	.000000	.000000	.000000
	.000000	.000000	.000000	.000000	.000000	.000000	.000000	.000000	.000000	.000000
INDEX#	.199159	SUM# \$		440000.01						

STEP	EXPENDITURES (1-10) / (11-20) /					GRADIENTS (1-10) / (11-20)				
15	.400000+05	.000000	.000000	.000000	.000000	.000000	.500000+05	.360000+06	.000000	.000000
	.000000	.000000	.000000	.000000	.000000	.000000	.000000	.000000	.000000	.000000
	.183093-06	.465159-07	.779815-07	.136074-08	.000000	.000000	.712891-07	.000000	.000000	.000000
	.000000	.000000	.000000	.000000	.000000	.000000	.000000	.000000	.000000	.000000
INDEX	.197569	SUM = 3		450000.00						
16	.500000+05	.000000	.000000	.000000	.000000	.000000	.500000+05	.360000+06	.000000	.000000
	.000000	.000000	.000000	.000000	.000000	.000000	.000000	.000000	.000000	.000000
	.187374-06	.476170-07	.797941-07	.139224-08	.000000	.000000	.731599-07	.000000	.000000	.000000
	.000000	.000000	.000000	.000000	.000000	.000000	.000000	.000000	.000000	.000000
INDEX	.195538	SUM = 3		460000.01						
17	.600000+05	.000000	.000000	.000000	.000000	.000000	.500000+05	.360000+06	.000000	.000000
	.000000	.000000	.000000	.000000	.000000	.000000	.000000	.000000	.000000	.000000
	.191871-06	.487474-07	.816946-07	.142824-08	.000000	.000000	.751302-07	.000000	.000000	.000000
	.000000	.000000	.000000	.000000	.000000	.000000	.000000	.000000	.000000	.000000
INDEX	.193665	SUM = 3		470000.01						
18	.700000+05	.000000	.000000	.000000	.000000	.000000	.500000+05	.360000+06	.000000	.000000
	.000000	.000000	.000000	.000000	.000000	.000000	.000000	.000000	.000000	.000000
	.196582-06	.499336-07	.836858-07	.145869-08	.246110-12	.000000	.777101-07	.000000	.000000	.000000
	.000000	.000000	.000000	.000000	.000000	.000000	.000000	.000000	.000000	.000000
INDEX	.191746	SUM = 3		480000.00						
19	.800000+05	.000000	.000000	.000000	.000000	.000000	.500000+05	.360000+06	.000000	.000000
	.000000	.000000	.000000	.000000	.000000	.000000	.000000	.000000	.000000	.000000
	.201530-06	.511799-07	.857775-07	.149561-08	.246110-12	.000000	.748080-07	.000000	.000000	.000000
	.000000	.000000	.000000	.000000	.000000	.000000	.000000	.000000	.000000	.000000
INDEX	.189780	SUM = 3		490000.00						
20	.900000+05	.000000	.000000	.000000	.000000	.000000	.500000+05	.360000+06	.000000	.000000
	.000000	.000000	.000000	.000000	.000000	.000000	.000000	.000000	.000000	.000000
	.206737-06	.524900-07	.879790-07	.153478-08	.246110-12	.000000	.000000	.000000	.000000	.000000
	.000000	.000000	.000000	.000000	.000000	.000000	.000000	.000000	.000000	.000000
INDEX	.187765	SUM = 3		500000.00						

 PATH-RECEIVER BREAKDOWN BY CELL

ZONE	CELL	LND USE	CELL POP.	TOTAL ADV. AFF. NU P-R MOOS	REMAINING ADV. AFF. W/ P-R MOOS	PER-CENT ADV. AFF. NO P-R MOOS	PER-CENT ADV. AFF. W/ P-R MOOS	P-R MOD TYPE	P-R MOD EXPENDITURE
1	1	1	137.5	65.2	0.0	87.445	0.000	12	340000.00
2	1	5	250.0	140.0	72.0	56.007	29.104	5	20000.00

 PATH-RECEIVER MOOS COST BREAKDOWN

SP-1	SP-2	SP-3	D-1	D-2	RELOCATE	SP-1/D-1	SP-2/D-1	SP-3/D-1	SP-1/D-2	SP-2/D-2	SP-3/D-2
0.	0.	0.	0.	20000.	0.	0.	0.	0.	0.	0.	340000.

PATH-RECEIVER EXPENDITURE = \$ 340000.00

COST OF NEXT P-R MEASURE = \$ 400000.00

 STATIONARY SOURCE SUMMARY

SOURCE	CH TYPE	EXPENSE
1	2	30000.00
2	1	20000.00

STATIONARY SOURCE EXPENDITURE = \$ 50000.

COST OF NEXT STATIONARY SOURCE MEASURE = \$ 10000.00

NB129P USER'S GUIDE
 EXAMPLES

MCR 76-15

FINAL EXPENDITURES:

90000.	0.	0.	0.	0.	0.	50000.	360000.	0.	0.
0.	0.	0.	0.	0.	0.	0.	0.	0.	0.

TOTAL = \$ 500000.

FINAL COUNTERMEASURE VARIABLES:

.400000-00	-.000000	-.000000	-.000000	-.000000	-.000000	.500000+05	.360000+06	.000000	.000000
.000000	.000000	.000000	.000000	.000000	.000000	.000000	.000000	.000000	.000000

IMPACT GRADIENT VECTOR (REDUCTION IN NII/S):

.206117-06	.524900-07	.074790-07	.153478-08	.246110-12	.000000	.000000	.000000	.000000	.000000	.000000
.000000	.000000	.000000	.000000	.000000	.000000	.000000	.000000	.000000	.000000	.000000

GRADIENT MAGNITUDE = .230718-06

COUNTERMEASURE RANKING:	1	3	2	4	5	0	7	6
SPENDING LIMIT REACHED:	0	0	0	0	0	0	0	0

NOISE IMPACT INDEX = .187765-00
 RED. FROM BASELINE = .400302-00
 COST/BENEFIT RATIO = .322273+08 \$/PERSON

5-17

NOISEP USER'S GUIDE

EXAMPLES

 TITLE- DATA SET:
 JOB DESCRIPTION:

SHORT EXAMPLE CASE
 TEST DATA FOR SHORT SAMPLE CASE INCLUDING STATIONARY SOURCE

 END =D=D

WYLE LABORATORIES

N01Z0P USER'S GUIDE

EXAMPLES

5.2 Example: San Francisco Bay Region Study Area II

This example was taken from work for the Motor Vehicle Manufacturers Association of the United States on improvements of the community noise countermeasures model, and on their application to two study areas in the San Francisco Bay Region. Figure 5-3 is a listing of the input data stream. With the exception of the STAS codeword ('stationary sources') all codewords are made use of. The output produced by N01Z0P 2.1 will be shown and discussed later. First, some of the input data which may not be understandable upon inspection is discussed in more detail. Only items specific to the use of this computer program are discussed, and not such things as the computation of baseline noise levels from traffic or aircraft, or the preparation of basic countermeasure cost functions.

The cell individual data is contained in lines 18 through 217 of Figure 5-3. Either 2 or 4 data cards are used per cell. Four cards are required only if the cell is affected by aircraft noise, i.e., has a positive noise level associated with source number 11 (the existence of 11 sources is indicated by the names given to these sources in the first halves of lines 5 - 15 of Figure 5-3). Discussing, as an example, the first cell, lines 18 through 21, we see on card 1 that the cell contains 228 people, that it would cost 1.75 million dollars to relocate the people (this high number includes the cost of real estate property), that the cell contains 50,000 square feet of floor area, that the lower criterion level is not specified (see line 328), and that the land use code is 11, i.e., a school (see line 339). On card 2 (line 18), are specified the noise levels due to the first 10 sources, starting with 46.5 dB for the first source (automobiles low speed). It may be seen that this cell is not affected by sources 2, 5, 9, and 10 (zero noise level specified; fields may also have been left blank). Card 3 contains 53.6 dB for the eleventh source.

The existence of 7 countermeasure indicators is signalled by the names given to these indicators on the second halves of lines 5 through 11 of Figure 5-3. Only countermeasure indicator number 6 (aircraft noise reduction due to SAM treatment) had to be specified on a cell individual basis. Card 4 (line 21) contains this indicator in the sixth position in the form 208200 indicating a 4 dB reduction (2 times 4 equals 8, see Section 2.2, type 10 countermeasure) due to countermeasure 9 specified in lines 244 through 245. All other indicators were the same at all cells and could therefore be specified using the 'IND' option (line 219 of Figure 5-3). These indicators were the same because they all refer to surface transport sources the noise level reductions of which

DEPT. OF ENVIRONMENTAL AFFAIRS

NOISE USER'S GUIDE

EXAMPLES

do not vary with location. Card type 5 is never required because indicators 8 through 20 are never used.

Countermeasures are defined in lines 227 through 254 of Figure 5-3. Countermeasure type 15 occurs four times: countermeasure numbers 1, 3, 4, and 5. Numbers 1 and 3 constitute a two-dimensional cost function as explained in Sections 2.2 and 4.2, applicable to automobiles. Numbers 4 and 5 constitute a two-dimensional cost function applicable to trucks. The cost function for new trucks (lines 268 to 271 of Figure 5-3) is the one of the example of Section 4.2, Figure 4-2.

For the calculation of the baseline noise energy contributions of the new and old automobile fleets for 1981, it was assumed that new and old vehicles would have the same fleet noise levels (Leq's). The noise energy is then divided the same way as the number of vehicles in the partial fleets which was determined to be 56.8 percent for old vehicles, and 43.2 percent for new vehicles. Hence the upper bounds of the feasible countermeasure variable range in lines 257 and 265.

For the calculation of the baseline noise energy contributions for the new and old truck fleets for 1981 a yearly old vehicle retention rate of 90 percent was used. Let x be a number proportional to the noise energy from the old fleet, y the one from the new fleet, and t the one from the total fleet. Also, let L_x be the fleet noise level in dB for the old trucks, L_y the one for the new ones. Then:

$$x + y = t$$

$$x = f_x * 10^{(L_x/10)}, \quad y = (1 - f_x) * 10^{(L_y/10)}$$

where f_x is the fraction of old vehicles in the 1981 truck fleet. One asterisk signifies multiplication, two asterisks signify 'raise to the power'. The noise energy contributions n_x (old trucks) and n_y (new trucks) can then be obtained:

$$n_x = x/t, \quad n_y = y/t$$

In the present case, $L_x=82.96$ dB, $L_y=82.29$ dB (these values were available from other concurrent work by Wyle Research). $f_x=0.9^{*6}$ (6 years instead of 5 years because L_x was applicable to 1975 and not to 1976). This results in $n_x=0.564$ and $n_y=0.436$ (see lines 273 and 269 of Figure 5-3).

NOIZOP USER'S GUIDE

EXAMPLES

The data factoring facility (line 359) was used to simulate noisier conditions than would be expected for 1981 if one assumes less noise enforcement effort than is currently the case in California. For motorcycles, the calculated fleet noise level increase for no enforcement was 2.366 dB; hence the factor $10^{0.2366} = 1.7244$. The numbers for trucks and automobiles were:

Trucks: 3.5 dB, $10^{0.35} = 2.2387$
Automobiles: 5.5 dB, $10^{0.55} = 3.548$

In many instances, values in the input data were entered with more decimal places than would be reasonable considering the available and necessary accuracy, this was done in order to make it easier to trace certain numbers at a later date.

When NOIZOP 2.1 is fed with the input of Figure 5-3 the secondary output of Figure 5-4 results. The associated primary output is shown in Figure 5-6 (41 pages long, appearing at the end of this chapter).

The outputs are largely self-explanatory. Section 2.11.3 may be consulted together with Figure 5-4, and Section 2.11.2 may be consulted together with Figure 5-6. Figure 5-5 shows the change of the Noise Impact Index with expenditures for the case of this example, and for a run where the gradient step size and the initial expenditure ratio were significantly larger. The drastic change in the slope with increasing expenditures indicates that, as expected, the noise reduction efficiency per dollar spent decreases. The large expenditure jumps are due to expenditures on the path-receiver countermeasure (mostly barriers). Its discontinuous character has been discussed in the last paragraph of Section 2.11.1: Only a whole barrier can be built, only a whole cell can be soundproofed at a time, and only all people can be relocated from one cell at a time. Partial jobs are not allowable.

It may be seen that the case with the larger step size and initial expenditure ratio uses much less steps, initially shows higher noise impact indices, but ends up at the same optimal point.

N81Z8P USER'S GUIDE

EXAMPLES

```

000001      T 8
000002      MENLO PARK, SAN FRANCISCO BAY REGION STUDY AREA II, 1981 POPULATION, 1976 COSTS.
000003      STUDY AREA II LOW COST FUNCTIONS, NEW AUTOMOB. CASE 3, AUTO METROFIT CASE 2.
000004      DTA 1 MASTER DATA FROM SA II, LOW MELOC, COSTS
000005      AUTOMOBILES LOW SPEED LINE SMC NEW AUTOS LO SP+LOC.TRAFF.SRC.MED.,CM #1
000006      AUTOMOBILES HIGH SPEED LINE SMC EXIST.AUTOS LO SP+LOC.TRAFF.SC.MED.,CM #3
000007      AUTOMOBILES LOCAL TRAFFIC SOURCE TRUCKS LO SP NEW VEH SOURCE MED., CM #4,
000008      TRUCKS LOW SPEED LINE SMC TRUCKS LO SP ENFORC.+RETRDF.SC.REO.,CM #5
000009      TRUCKS HIGH SPEED LINE SMC TRUCK TIMES SOURCE MED., CM # 6
000010      MOTORCYCLES LOW SPEED LINE SMC AIRCRAFT SAM TREATMENT, CM # 9
000011      MOTORCYCLES LOCAL TRAFFIC SOURCE RAILROAD LOCO SOURCE MED, CM # 12
000012      BUSES LOW SPEED LINE SMC.
000013      RAILROAD LOCOMOTIVES, LINE 3.
000014      RAILROAD CARS, LINE SOURCE
000015      AIRCRAFT COMMERCIAL, FLIGHT
000016
000017      1 1 1 1 1 1 1 1 1 1
000018      001001 1226. 1750.0 50.00
000019      001001 2 46.5 0.0 43.7 48.7 11. 54.1 59.0 37.3 0.0 0.0
000020      001001 3 52.6
000021      001001 4 208200
000022      001101 10. 1750.0 50.00
000023      001101 2 40.5 0.0 37.3 42.7 11. 48.1 53.0 0.0 0.0 0.0
000024      001101 3 45.5
000025      001101 4 212200
000026      002001 16. 66.3 4.13
000027      002001 2 56.5 0.0 43.7 59.0 4. 62.6 59.0 0.0 0.0 0.0
000028      002001 3 52.8
000029      002001 4 208200
000030      002101 110. 66.3 4.13
000031      002101 2 50.5 0.0 37.3 53.9 4. 56.6 53.0 0.0 0.0 0.0
000032      002101 3 45.6
000033      002101 4 212200
000034      003001 1270. 9999999350.0
000035      003001 2 48.6 0.0 43.7 55.0 5. 54.8 59.0 31.9 61.5 52.7
000036      003001 3 48.3
000037      003001 4 208200
000038      003101 115. 9999999350.0
000039      003101 2 42.6 0.0 37.3 49.0 5. 48.1 53.0 0.0 57.4 47.2
000040      003101 3 40.5
000041      003101 4 208200
000042      004001 133. 235.1 15.38
000043      004001 2 51.8 0.0 43.7 54.0 1. 59.7 59.0 45.6 0.0 0.0
000044      004001 3 52.5
000045      004001 4 208200
000046      004101 154. 235.1 15.38
000047      004101 2 45.8 0.0 37.3 48.0 1. 53.7 53.0 0.0 0.0 0.0
000048      004101 3 45.3
000049      004101 4 212200
000050      004002 143. 316.6 20.63
000051      004002 2 39.1 0.0 43.7 41.2 1. 46.8 59.0 32.6 55.2 51.2
000052      004002 3 52.5
000053      004002 4 208200
000054      004102 170. 316.6 20.63
000055      004102 2 33.1 0.0 37.3 35.2 1. 48.8 53.0 0.0 50.4 46.4
000056      004102 3 45.3
000057      004102 4 214200
000058      005001 163. 1319.3 79.13 1.

```

Figure 5-3. Input Stream for San Francisco Example. The left-most column is not part of the input data; it provides a line count for this figure.

NOIZOP USER'S GUIDE

EXAMPLES

000059	005001	2	60.8	0.0	43.7	64.3	0.0	67.0	59.0	45.6	0.0	0.0
000060	005001	3	51.0									
000061	005001	4						208200				
000062	005101	1	1136.	1319.3	79.15		1.					
000063	005101	2	54.8	0.0	37.3	58.3	0.0	61.0	53.0	0.0	0.0	0.0
000064	005101	3	43.8									
000065	005101	4						210200				
000066	005002	1	106.	921.8	42.75		1.					
000067	005002	2	41.1	0.0	43.7	43.3	0.0	48.8	59.0	35.6	0.0	0.0
000068	005102	1	1107.	921.8	42.75		1.					
000069	005102	2	35.1	0.0	37.3	37.3	0.0	42.8	53.0	0.0	0.0	0.0
000070	006001	1	145.	518.4	28.50		1.					
000071	006001	2	49.3	0.0	43.7	51.6	0.0	54.6	59.0	45.2	65.7	61.7
000072	006101	1	174.	518.4	28.50		1.					
000073	006101	2	43.3	0.0	37.3	45.6	0.0	50.6	53.0	0.0	60.9	56.9
000074	006002	1	115.	151.0	6.25		1.					
000075	006002	2	37.0	0.0	43.7	39.2	0.0	43.9	59.0	0.0	52.7	47.9
000076	006102	1	124.	151.0	6.25		1.					
000077	006102	2	31.0	0.0	37.3	33.2	0.0	37.9	53.0	0.0	48.0	43.2
000078	007001	1	124.	301.7	15.38		1.					
000079	007001	2	61.0	0.0	43.7	64.4	0.0	67.1	59.0	45.6	0.0	0.0
000080	007101	1	139.	301.7	15.38		1.					
000081	007101	2	58.4	0.0	37.3	56.4	0.0	61.1	53.0	0.0	0.0	0.0
000082	007002	1	141.	504.2	28.50		1.					
000083	007002	2	39.9	0.0	43.7	42.1	0.0	47.3	59.0	35.6	0.0	0.0
000084	007102	1	167.	504.2	28.50		1.					
000085	007102	2	33.9	0.0	37.3	36.1	0.0	41.3	53.0	0.0	0.0	0.0
000086	008001	1	1132.	1176.3	78.75		1.					
000087	008001	2	63.9	0.0	43.7	64.4	0.0	69.9	59.0	45.6	0.0	0.0
000088	008001	3	49.7									
000089	008001	4						206200				
000090	008101	1	1217.	1176.3	78.75		1.					
000091	008101	2	57.9	0.0	37.3	58.4	0.0	61.9	53.0	0.0	0.0	0.0
000092	008101	3	42.3									
000093	008101	4						210200				
000094	008002	1	110.	209.1	12.00		1.					
000095	008002	2	51.7	0.0	43.7	55.3	0.0	63.8	59.0	32.6	0.0	0.0
000096	008002	3	51.1									
000097	008002	4						208200				
000098	008102	1	129.	209.1	12.00		1.					
000099	008102	2	45.7	0.0	37.3	49.3	0.0	57.8	53.0	0.0	0.0	0.0
000100	008102	3	43.9									
000101	008102	4						210200				
000102	009001	1	183.	1758.5	62.25		1.					
000103	009001	2	0.0	0.0	43.7	0.0	0.0	0.0	59.0	0.0	71.8	62.4
000104	009001	3	48.5									
000105	009001	4						206200				
000106	009101	1	1136.	1758.5	62.25		1.					
000107	009101	2	0.0	0.0	37.3	0.0	0.0	0.0	51.0	0.0	67.8	56.3
000108	009101	3	41.0									
000109	009101	4						208200				
000110	009002	1	127.	480.2	24.00		1.					
000111	009002	2	48.5	0.0	43.7	52.1	0.0	54.8	59.0	32.6	63.6	53.5
000112	009002	3	51.4									
000113	009002	4						208200				
000114	009102	1	145.	480.2	24.00		1.					
000115	009102	2	42.5	0.0	37.3	46.3	0.0	48.8	53.0	0.0	59.6	47.4
000116	009102	3	44.3									
000117	009102	4						212200				
000118	010001	1	116.	498.9	10.50		1.					

Figure 5-3 (Continued)

N0120P USER'S GUIDE

EXAMPLES

000119	010001	2	0.0	0.0	45.7	0.0	0.0	0.0	54.0	0.0	71.8	67.8
000120	010001	3	47.8									
000121	010001	4						208200				
000122	010101	129.	498.0	10.50				1.				
000123	010101	2	0.0	0.0	37.3	0.0	0.0	0.0	53.0	0.0	62.4	56.3
000124	010101	3	40.2									
000125	010101	4						208200				
000126	010002	13.	67.5	2.63				1.				
000127	010002	2	50.1	0.0	43.7	53.0	0.0	57.0	59.0	37.7	0.0	0.0
000128	010102	15.	67.5	2.63				1.				
000129	010102	2	44.1	0.0	37.3	47.0	0.0	51.0	53.0	0.0	0.0	0.0
000130	011001	110.	322.3	8.25				1.				
000131	011001	2	58.0	0.0	43.7	60.3	0.0	66.0	59.0	50.7	0.0	0.0
000132	011101	116.	322.3	8.25				1.				
000133	011101	2	52.0	0.0	37.3	54.3	0.0	60.0	53.0	0.0	0.0	0.0
000134	011002	18.	283.9	6.00				1.				
000135	011002	2	49.2	0.0	43.7	52.0	0.0	56.2	59.0	40.5	0.0	0.0
000136	011102	113.	283.9	6.00				1.				
000137	011102	2	43.2	0.0	37.3	46.0	0.0	50.2	53.0	0.0	0.0	0.0
000138	012001	1228.	1750.0	50.00				11.				
000139	012001	2	46.4	0.0	43.7	46.0	0.0	54.0	59.0	39.2	0.0	0.0
000140	012101	10.	1750.0	50.00				11.				
000141	012101	2	40.4	0.0	37.3	42.6	0.0	48.0	53.0	0.0	0.0	0.0
000142	013001	171.	1766.0	54.75				1.				
000143	013001	2	55.8	0.0	43.7	58.1	0.0	63.7	59.0	48.9	0.0	0.0
000144	013101	1116.	1766.0	54.75				1.				
000145	013101	2	49.6	0.0	37.3	52.1	0.0	57.7	53.0	0.0	0.0	0.0
000146	013002	124.	558.0	16.50				1.				
000147	013002	2	45.7	0.0	43.7	47.9	0.0	53.4	59.0	37.7	0.0	0.0
000148	013102	159.	558.0	16.50				1.				
000149	013102	2	39.7	0.0	37.3	41.9	0.0	47.4	53.0	0.0	0.0	0.0
000150	014001	1341.	40000.0	8000.00				12.				
000151	014001	2	49.0	49.2	43.7	50.5	53.3	55.9	59.0	33.4	0.0	0.0
000152	014101	1269.	40000.0	8000.00				12.				
000153	014101	2	43.0	43.2	37.3	44.5	47.3	49.9	53.0	0.0	0.0	0.0
000154	015001	126.	692.4	23.25				1.				
000155	015001	2	53.6	0.0	43.7	46.1	0.0	61.7	59.0	46.5	0.0	0.0
000156	015101	143.	692.4	23.25				1.				
000157	015101	2	47.8	0.0	37.3	50.1	0.0	55.7	53.0	0.0	0.0	0.0
000158	015002	127.	578.6	21.36				1.				
000159	015002	2	51.2	0.0	43.7	52.8	0.0	57.2	59.0	48.5	0.0	0.0
000160	015102	144.	578.6	21.36				1.				
000161	015102	2	45.2	0.0	37.3	46.8	0.0	51.2	53.0	0.0	0.0	0.0
000162	015003	1219.	5058.5	200.63				1.				
000163	015003	2	43.0	0.0	43.7	44.5	0.0	50.3	59.0	38.5	0.0	0.0
000164	015103	1159.	5058.5	200.63				1.				
000165	015103	2	37.0	0.0	37.3	38.5	0.0	44.3	53.0	0.0	0.0	0.0
000166	016001	1117.	2661.4	94.13				4.				
000167	016001	2	0.0	0.0	43.7	0.0	0.0	0.0	59.0	0.0	71.8	62.4
000168	016101	1191.	2661.4	94.13				4.				
000169	016101	2	0.0	0.0	37.3	0.0	0.0	0.0	53.0	0.0	67.8	56.3
000170	017001	152.	422.9	29.63				1.				
000171	017001	2	00.0	0.0	43.7	0.0	0.0	0.0	59.0	0.0	65.9	61.9
000172	017101	186.	422.9	29.63				1.				
000173	017101	2	0.0	0.0	37.3	0.0	0.0	0.0	53.0	0.0	61.1	57.1
000174	017002	158.	437.1	30.38				1.				
000175	017002	2	55.6	57.9	43.7	55.2	62.0	64.4	59.0	0.0	52.7	48.0
000176	017102	195.	437.1	30.38				1.				
000177	017102	2	50.6	52.9	37.3	50.2	56.0	58.4	53.0	0.0	47.9	43.2
000178	018001	134.	523.9	27.00				1.				

Figure 5-3 (Continued)

NOISE USER'S GUIDE

EXAMPLES

000179	018001	2	62.1	0.0	43.7	65.5	0.0	68.2	59.0	50.4	0.0	0.0
000180	018101	155.	523.4	27.00			1.					
000181	018101	2	50.1	0.0	37.3	59.5	0.0	62.2	55.0	0.0	0.0	0.0
000182	018002	139.	657.0	32.43			1.					
000183	018002	2	41.7	0.0	43.7	43.8	0.0	49.3	59.0	35.9	0.0	0.0
000184	018102	165.	657.0	32.43			1.					
000185	018102	2	35.7	0.0	37.3	37.8	0.0	43.3	53.0	0.0	0.0	0.0
000186	019001	1228.	1750.0	50.00			11.					
000187	019001	2	40.0	0.0	43.7	42.1	0.0	47.6	59.0	0.0	0.0	0.0
000188	019101	10.	1750.0	50.00			11.					
000189	019101	2	54.0	0.0	37.3	36.1	0.0	41.6	53.0	0.0	0.0	0.0
000190	020001	117.	268.4	16.13			4.					
000191	020001	2	67.2	64.5	43.7	66.5	73.3	74.2	59.0	0.0	0.0	0.0
000192	020101	129.	268.4	16.13			4.					
000193	020101	2	61.2	63.5	37.3	60.5	67.3	68.2	53.0	0.0	0.0	0.0
000194	021001	179.	1096.6	57.75			1.					
000195	021001	2	67.2	69.5	43.7	66.5	73.3	74.2	59.0	45.9	0.0	0.0
000196	021101	1130.	1096.6	57.75			1.					
000197	021101	2	62.2	63.5	37.3	60.5	67.3	68.2	53.0	0.0	0.0	0.0
000198	021002	1117.	1619.9	86.13			1.					
000199	021002	2	55.6	57.9	43.7	55.6	62.0	62.9	59.0	35.9	0.0	0.0
000200	021102	1191.	1619.9	86.13			1.					
000201	021102	2	49.6	51.9	37.3	49.6	56.0	56.9	53.0	0.0	0.0	0.0
000202	021003	159.	992.6	48.38			1.					
000203	021003	2	52.5	54.3	43.7	52.6	58.4	58.5	59.0	34.2	0.0	0.0
000204	021103	196.	992.6	48.38			1.					
000205	021103	2	46.5	48.3	37.3	46.6	52.4	54.5	53.0	0.0	0.0	0.0
000206	022001	1126.	949.5	68.25			1.					
000207	022001	2	67.2	69.5	43.7	66.5	73.3	74.2	59.0	0.0	0.0	0.0
000208	022101	1207.	949.5	68.25			1.					
000209	022101	2	61.2	63.5	37.3	60.5	67.3	68.2	53.0	0.0	0.0	0.0
000210	022002	1125.	1017.9	72.75			1.					
000211	022002	2	57.1	57.9	43.7	56.3	62.0	64.0	59.0	35.5	0.0	0.0
000212	022102	1205.	1017.9	72.75			1.					
000213	022102	2	51.1	51.9	37.3	52.3	56.0	58.0	53.0	0.0	0.0	0.0
000214	023001	1228.	1750.0	50.00			11.					
000215	023001	2	60.6	62.9	43.7	60.2	67.0	67.7	59.0	0.0	0.0	0.0
000216	023101	10.	1750.0	50.00			11.					
000217	023101	2	54.6	56.9	37.3	54.2	61.0	61.7	53.0	0.0	0.0	0.0
000218												
000219	IND											
000220	1	207207	MAX. REDUCTION IS 3.5 DB APPLYING TO SOURCES 1 AND 3									
000221	2	207207	MAX. REDUCTION IS 3.5 DB APPLYING TO SOURCES 1 AND 3									
000222	3	222200	MAX. RED. IS 11 DB APPLYING TO SOURCE 4									
000223	4	224200	MAX. RED. IS 12 DB APPLYING TO SOURCE 4									
000224	5	210200	TME PER TRUCK REDUCTION IS 5 DB APPLYING TO SOURCE 5									
000225	7	212200	TME PER LUGGATIVE REDUCTION IS 6 DB APPLYING TO SOURCE 9									
000226												
000227	CM	SA 11	COUNTERMEASURE DEFINITIONS									
000228	AUTOMOBILES	L04	SPEED NEW VEHICLES SOURCE REDUCTION									
000229	15	1	3									
000230	AUTOMOBILES	L04	SPEED DUS ENFORCEMENT									
000231	12	1	3									
000232	AUTOMOBILES	L04	SPEED EXISTING VEHICLES RETROFIT SOURCE REDUCTION									
000233	15	1	3									
000234	TRUCKS	L04	SPEED NEW VEHICLES SOURCE REDUCTION									
000235	15	4	3									
000236	TRUCKS	L04	SPEED DUS ENFORCEMENT AND RETROFIT SOURCE REDUCTION									
000237	15	4	4									
000238	TRUCKS	L04	HIGH SPEED TIME NOISE REDUCTION									

Figure 5-3 (Continued)

NOISE USER'S GUIDE

EXAMPLES

```

000239      10  5      5
000240      BUSES      LDA  SPEED SOURCE REDUCTION, NEW AND EXISTING VEHICLES
000241      12  8
000242      MOTORCYCLES LDA  SPEED DUS ENFORCEMENT
000243      12  6  7
000244      AIRCRAFT  SOUND ABSORPTION MATERIAL FACELLE TREATMENT SOURCE REDUCTION
000245      10  11
000246      AIRCRAFT  FLIGHT PATH REROUTING (EFFECTIVELY A FLIGHT FREQUENCY RED.)
000247      1  11
000248      AIRCRAFT  REDUCTION OF NIGHT OPERATIONS
000249      3  11
000250      RAILROAD  LOCOMOTIVE MUFFLERS, SOURCE REDUCTION
000251      10  9
000252      PATH-RECEIVER CONTROL INSULATION, BARRIERS, LAND ACQ. AND PEOPLE RELOC.
000253      20
000254
000255      COST SA II (MENLO PARK) LDA COST FUNCTIONS
000256      COST FUNCTION FOR AUTOMOBILES LDA SPEED NEW VEHICLES SOURCE RED., CASE 3
000257      0  0.432
000258      0  0.161  0.286  0.389  0.432
000259      0  14.315  47.715  162.231  248.118
000260      COST FUNCTION FOR AUTOMOBILES LDA SPEED DUS ENFORCEMENT
000261      0  0.2
000262      0  4.5  5.5  5.8  6.2
000263      0  .25448 .76344  3.11738  12.43771
000264      COST FUNCTION FOR AUTOMOBILES LDA SP. EXIST. VEH. RETROFIT, CASE 2
000265      0  0.568
000266      0  0.211  0.379  0.512  0.568
000267      0 .064 .213 .751 1.113
000268      COST FUNCTION FOR TRUCKS LDA SPEED NEW VEH. SOURCE REDUCTION
000269      0  0.436
000270      0  0.236  0.355  0.407  0.436
000271      0  31.81  63.62  181.145  222.678
000272      COST FUNCTION FOR TRUCKS LDA SPEED DUS ENFORCEMENT AND RETROFIT SOURCE R
000273      0  0.564
000274      0  0.333  0.412  0.507  0.564
000275      0 .095 4. 12. 143.
000276      COST FUNCTION FOR TRUCKS MI SPEED TIME NOISE REDUCTION
000277      0  1
000278      0  1
000279      0  92.08995
000280      COST FUNCTION FOR BUSES LDA SP. SOURCE RED., NEW AND EXIST. VEHICLES
000281      0  6.78
000282      0  0.23  2.35  6.78
000283      0 .03181 1.78156 16.2211
000284      COST FUNCTION FOR MOTORCYCLES LDA SPEED DUS ENFORCEMENT
000285      0  17
000286      0  5.04  9.46  12.75  17
000287      0 .01591 .06362 .15905 .44624
000288      COST FUNCTION FOR AIRCRAFT SAN SOURCE REDUCTION
000289      0  1
000290      0  1
000291      0  19.27666
000292      COST FUNCTION FOR AIRCRAFT FLIGHT PATH REROUTING (AFREQ. REDUCTION)
000293      0  1
000294      0  1
000295      0  9.06585
000296      COST FUNCTION FOR AIRCRAFT NIGHT OPERATIONS REDUCTION
000297      0  1
000298      0  1

```

Figure 5-3 (Continued)

NOISE USER'S GUIDE

EXAMPLES

```

000299      0 32.7641
000300      COST FUNCTION FOR LUCUMOTIVE MUFFLENS, SOURCE REDUCTION
000301      0      1
000302      0      1
000303      0 16.2251
000304
000305      BAR      BARRIER DATA SA II LOW COST
000306      BARRIERS FOR STUDY AREA II (MENLO PARK), LOW COST
000307      1.25 1.25 .0 1.0 1.1 1.25 .0 1.0 .5 1.5 .0
000308      1.5 1.5 .0 1.4 1.5 1.5 .0 1.4 1. 1.5 .0
000309      1      37.6      55.8 23 1      8      8
000310      2      167.2      248.4 22 1      10      10 22 2      8      8
000311      3      167.2      248.4 21 1      10      10 21 2      8      8 21 3      6      6
000312      4      51.9      77.1 20 1      10      10
000313      6      192.9      289.7 6 1      10      10 6 2      8      8
000314      7      505.3      759.0 17 1      10      10 17 2      8      8
000315      8      257.0      386.0 10 1      10      10
000316      9      412.7      649.9 9 1      10      10 9 2      8      8
000317      10     171.3      257.3 16 1      10      10
000318
000319      PAWE
000320      SOUNDPROOFING DATA SA II (MENLO PARK), LOW COST ESTIMATES; ALL PR OPTIONS
000321      1      1      1      1      1      1      1      1      1      1      1
000322      5      10      15
000323      2.25      6.44      11.66
000324      5      10      15
000325      2.25      6.44      11.66
000326      CRIT 0 SALLON MORE THAN 100 PERC. ADV. EFFECT
000327      1
000328      CRIT 0 OTRANSF.FCT. FOR SFU STUDY, 20 DB RANGE
000329      57      49      SINGLE FAMILY RESIDENTIAL      D/N LOWER CRITERION LEVELS
000330      NOT USED
000331      NOT USED
000332      62      49      MULTIFAMILY RESIDENTIAL      D/N LOWER CRITERION LEVELS
000333      62      62      COMMERCIAL      D/N LOWER CRITERION LEVELS
000334      NOT USED
000335      NOT USED
000336      70      70      INDUSTRIAL      D/N LOWER CRITERION LEVELS
000337      NOT USED
000338      NOT USED
000339      57      57      SCHOOLS, NIGHT NOT USED      DAY LOWER CRITERION LEVEL
000340      60      57      HOSPITALS AND NURSING HOMES      D/N LOWER CRITERION LEVELS
000341      NOT USED
000342      NOT USED
000343      NOT USED
000344      77      69      SINGLE FAMILY RESIDENTIAL      D/N UPPER CRITERION LEVELS
000345      NOT USED
000346      NOT USED
000347      62      60      MULTIFAMILY RESIDENTIAL      D/N UPPER CRITERION LEVELS
000348      62      62      COMMERCIAL      D/N UPPER CRITERION LEVELS
000349      NOT USED
000350      NOT USED
000351      90      90      INDUSTRIAL      D/N UPPER CRITERION LEVELS
000352      NOT USED
000353      NOT USED
000354      77      77      SCHOOLS, NIGHT NOT USED      DAY UPPER CRITERION LEVEL
000355      60      77      HOSPITALS AND NURSING HOMES      D/N UPPER CRITERION LEVELS
000356      NOT USED
000357      NOT USED
000358      NOT USED

```

Figure 5-3 (Continued)

DEPT. CIVIL ENGINEERING

NOIZOP USER'S GUIDE

EXAMPLES

```
000359
000360
000361
000362
000363
000364
000365
000366
000367
000368
000369
000370
000371
```

FAC 1 SFO SA II (MENLO PARK)
SIMULATE BASELINE MOTOR VEHICLE LEVELS (I.E., FOR NO ENFORCEMENT)

3.5481			3.5481	2.2367		1.7244	1.7244			
--------	--	--	--------	--------	--	--------	--------	--	--	--

BASE
HANK
OPT

.763440 5. 2.

END

Figure 5-3 (Continued)

N0120P USER'S GUIDE

EXAMPLES

```

20 JOB DESCRIPTION:
30 STUDY AREA II LOW COST FUNCTIONS, NEW
40 AUTOMOB. CASE 3, AUTO RETROFIT CASE 2.
50 ---- DTA 1 1
60 DATA ENTERED FOR 78 CELLS
70 ---- CM -0-0
80 13 COUNTERMEASURES DEFINED
90 ---- COST -0-0
100 12 COST FUNCTIONS READ
110 ---- BAR -0-0
120 DATA READ FOR 9 BARRIERS
130 ---- PAIR -0-0
140 INPUT OF SOUNDPROOFING DATA COMPLETE
150 ---- CRIT -0 3
160 TRANSFER FUNCTION TYPE 1 BULGE FACTOR = 1.00
170 ---- CRIT 0 0
180 CRITERION LEVELS CHANGED
190 ---- FAC 1-0
200 DATA FACTORING COMPLETE
210 ---- HASE -0-0
220 BASELINE NII = .579245
230 ---- RANK -0-0
240 MUSI OFFENDING SOURCES:
250 1 MOTORCYCLES LOW SPEED LINE SRC. ( 6)
260 2 MOTORCYCLES LOCAL TRAFFIC SOURCE ( 7)
270 3 RAILROAD LOCOMOTIVES, LINE S. ( 9)
280 4 AUTOMOBILES LOW SPEED LINE SRC ( 1)
290 5 TRUCKS LOW SPEED LINE SRC. ( 4)
300 6 TRUCKS HIGH SPEED LINE SRC. ( 5)
310 7 AUTOMOBILES HIGH SPEED LINE SRC ( 2)
320 8 RAILROAD CARS, LINE SOURCE (10)
330 9 AUTOMOBILES LOCAL TRAFFIC SOURCE ( 3)
340 10 AIRCRAFT COMMERCIAL, FLIGHT (11)
350 11 BUSES LOW SPEED LINE SRC. ( 8)
360 ---- OPT -0-0
370 STEP CM TOTAL (ALL CM) NII
380 1 0 .00 .579245
390 2 8 496.24 .393895
400 3 2 6485.01 .357453
410 4 5 16478.51 .336765
420 5 3 17591.51 .331039
430 6 12 27375.66 .313280
440 7 12 33814.61 .298176
450 8 13 71414.61 .279297
460 9 4 77819.92 .276659
470 10 4 84505.46 .273787
480 11 4 91521.90 .270629
490 12 4 98885.17 .267154
500 13 4 106024.78 .264358
510 14 13 124229.78 .258602
520 15 13 291429.78 .212905
530 16 10 296569.04 .211593
540 17 4 301799.18 .210295
550 18 4 307162.69 .208930
560 19 4 312671.39 .207491
570 20 4 318320.01 .205981
580 21 4 324079.58 .204410
590 22 13 491279.58 .164944

```

Figure 5-4. San Francisco Example Secondary Output. The left-most column provides a line count which does not usually appear.

NOI28P USER'S GUIDE

EXAMPLES

600	23	10	495206.16	.164013		
610	24	6	500206.16	.163132		
620	25	6	505206.16	.162231		
630	26	6	510206.16	.161311		
640	27	6	515206.16	.160369		
650	28	6	520206.16	.159406		
660	29	6	525206.16	.158419		
670	30	6	530206.16	.157409		
680	31	6	535206.16	.156534		
690	32	6	540206.16	.155810		
700	33	6	545206.16	.155065		
710	34	6	550206.15	.154300		
720	35	6	555206.15	.153513		
730	36	6	560206.15	.152703		
740	37	6	565206.15	.151987		
750	38	6	570206.15	.151252		
760	39	6	575206.15	.150492		
770	40	6	580206.15	.149706		
780	41	6	585206.15	.148890		
790	42	6	587296.11	.148541		
800	43	2	592296.10	.147828		
810	44	2	593745.05	.147631		
820	45	5	598745.04	.146348		
830	46	4	603745.04	.145823		
840	47	5	608745.05	.144537		
850	48	5	613745.04	.143211		
860	49	5	618745.04	.141873		
870	50	1	623745.04	.141180		
880	51	1	628745.04	.140476		
890	52	13	709945.05	.133280		
900	53	1	714945.04	.132619		
910	54	13	738570.04	.130968		
920	55	7	743570.04	.130639		
930	56	4	748570.05	.130370		
940	57	4	753570.04	.130100		
950	58	4	758570.05	.129828		
960	59	4	763440.00	.129561		
970	FINAL EXPENDITURES:					
980	\$	15000.	\$	12438.	\$	1113.
990	\$	92090.	\$	5000.	\$	496.
1000	\$	0.	\$	16223.	\$	495025.
1010	\$	0.	\$	0.	\$	0.
1020	FINAL NII = .129561-00					
1030	---- END -0-0					
					66996.	29993.
					0.	9066.
					0.	0.
					0.	0.

Figure 5-4 (Continued)

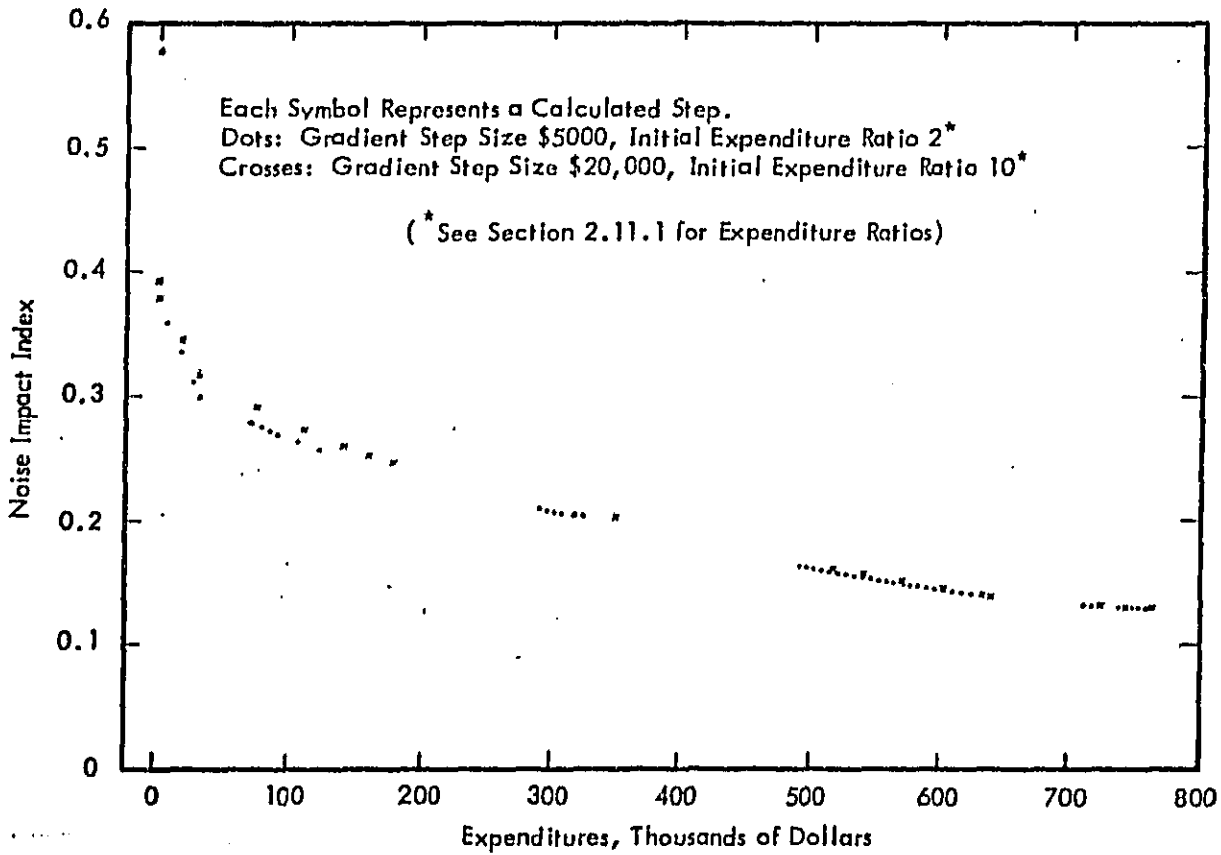

Figure 5-5 . Noise Impact Index Versus Expenditures

```

.....
COMMUNITY NOISE OPTIMIZATION
PROGRAM
NOIZOP VERSION 2.1
-----
HYLE LABORATORIES
.....

```

```

.....
TITLE- DATA SETS
JOB DESCRIPTIONS
.....

```

```

MENLO PARK, SAN FRANCISCO BAY REGION STUDY AREA II, 1981 POPULATION- 1974 COSTS,
STUDY AREA II LOW COST FUNCTIONS, NEW AUTOMOB. CASE 3, AUTO RETROFIT CASE 2.

```

Figure 5-6. Output of San Francisco Example. (Figure 5-3 shows the input data that generated this output. Consult Chapter 2 in this manual for detailed explanation.)

TITLE- DATA SET:
JOB DESCRIPTION:

MENLO PARK, SAN FRANCISCO BAY REGION STUDY AREA 11, 1981 POPULATION, 1976 COSTS,
STUDY AREA 11 LOW COST FUNCTIONS, NEW AUTOMOB. CASE 3, AUTO RETROFIT CASE 2.

OTA 1 1

MASTER DATA FOR SA 11, LOW RELUC. COSTS

SOURCES	INDICATIONS
1 AUTOMOBILES LOW SPEED LINE SRC	1 NEW AUTOS LO SP+LOC.THAFF.SRC.RED.,CM #1
2 AUTOMOBILES HIGH SPEED LINE SRC	2 EXIST.AUTOS LO SP+LOC.THAFF.SC.RED.,CM #3
3 AUTOMOBILES LOCAL TRAFFIC SOURCE	3 TRUCKS LO SP NEW VEH SOURCE RED., CM #8.
4 TRUCKS LOW SPEED LINE SRC.	4 TRUCKS LO SP ENFORC.METHOD.SC.RED.,CM #5
5 TRUCKS HIGH SPEED LINE SRC.	5 TRUCK TIRES SOURCE RED., CM # 6
6 MOTORCYCLES LOW SPEED LINE SRC.	6 AIRCRAFT SAM TREATMENT, CM # 9
7 MOTORCYCLES LOCAL TRAFFIC SOURCE	7 RAILROAD LOCO SOURCE RED, CM # 12
8 BUSES LOW SPEED LINE SRC.	
9 RAILROAD LOCOMOTIVES, LINE 5.	
10 RAILROAD CARS, LINE SOURCE	
11 AIRCRAFT COMMERCIAL, FLIGHT	

SOURCE CONTRIBUTION ELEMENTS FOR BASELINE INDEX:

1 1 1 1 1 1 1 1 1-0-0-0-0-0-0-0-0

DATA ENTERED FOR 78 CELLS

ZONE	CELL	EFF. POP.	REL. COST (5000'S)	FLH. AREA (000'S)	50. FT. CL	LAD USE	SOURCES (1-10) / (11-20) / INDICATORS (1-10) / (11-20)											
							46.5	52.6	207207	222200	224200	210200	208200	212200	37.3	.0	.0	
1	1	142.5	1750.	50.	0	11	46.5	52.6	207207	222200	224200	210200	208200	212200	37.3	.0	.0	
1	101	.0	1750.	50.	0	11	40.5	45.5	207207	222200	224200	210200	212200	212200	.0	.0	.0	
2	1	3.0	66.	4.	0	4	50.5	52.8	207207	222200	224200	210200	208200	212200	.0	.0	.0	
2	101	3.0	66.	4.	0	4	50.5	45.6	207207	222200	224200	210200	212200	212200	.0	.0	.0	
3	1	100.09999999		350.	0	5	46.6	48.3	207207	222200	224200	210200	208200	212200	31.9	61.5	52.7	
3	101	9.09999999		350.	0	5	42.6	40.5	207207	222200	224200	210200	208200	212200	.0	37.4	47.2	
4	1	20.6	235.	15.	0	1	51.0	42.5	207207	222200	224200	210200	208200	212200	45.6	.0	.0	
4	101	20.3	235.	15.	0	1	45.0	45.3	207207	222200	224200	210200	212200	212200	.0	.0	.0	
4	2	26.9	317.	21.	0	1	34.1	52.5	207207	222200	224200	210200	208200	212200	32.6	55.2	51.2	
4	102	26.3	317.	21.	0	1	33.1	45.3	207207	222200	224200	210200	214200	212200	.0	50.4	46.4	

DPT COPY WITH...

ZONE	CELL	EFF. POP.	REL. COST (1000'S)	FLW. AREA SQ. FT. (1000'S)	CL	LND USE	SOURCES (1-10) / (11-20) / INDICATORS (1-10) / (11-20)									
							60.8	51.0	207207	222200	224200	210200	208200	212200	45.6	.0
5	1	51.9	1319.	79.	0	1	60.8	.0	45.7	64.3	.0	67.0	59.0	45.6	.0	.0
							51.0	.0	.0	.0	.0	.0	.0	.0	.0	.0
							207207	207207	222200	224200	210200	208200	212200	0	0	0
							0	0	0	0	0	0	0	0	0	0
5	101	51.0	1319.	79.	0	1	54.0	.0	37.4	56.3	.0	61.0	53.0	.0	.0	.0
							43.0	.0	.0	.0	.0	.0	.0	.0	.0	.0
							207207	207207	222200	224200	210200	210200	212200	0	0	0
							0	0	0	0	0	0	0	0	0	0
5	2	41.3	922.	43.	0	1	41.1	.0	43.7	43.3	.0	48.0	59.0	35.6	.0	.0
							.0	.0	.0	.0	.0	.0	.0	.0	.0	.0
							207207	207207	222200	224200	210200	0	212200	0	0	0
							0	0	0	0	0	0	0	0	0	0
5	102	40.1	922.	43.	0	1	39.1	.0	37.3	37.3	.0	42.0	53.0	.0	.0	.0
							.0	.0	.0	.0	.0	.0	.0	.0	.0	.0
							207207	207207	222200	224200	210200	0	212200	0	0	0
							0	0	0	0	0	0	0	0	0	0
6	1	26.1	510.	29.	0	1	49.3	.0	43.7	51.6	.0	56.6	59.0	45.2	65.7	61.7
							.0	.0	.0	.0	.0	.0	.0	.0	.0	.0
							207207	207207	222200	224200	210200	0	212200	0	0	0
							0	0	0	0	0	0	0	0	0	0
6	101	27.0	510.	29.	0	1	43.3	.0	37.3	45.6	.0	50.6	53.0	.0	60.9	56.9
							.0	.0	.0	.0	.0	.0	.0	.0	.0	.0
							207207	207207	222200	224200	210200	0	212200	0	0	0
							0	0	0	0	0	0	0	0	0	0
6	2	9.4	151.	6.	0	1	37.0	.0	43.7	39.2	.0	43.9	59.0	.0	52.7	47.9
							.0	.0	.0	.0	.0	.0	.0	.0	.0	.0
							207207	207207	222200	224200	210200	0	212200	0	0	0
							0	0	0	0	0	0	0	0	0	0
6	102	9.0	151.	6.	0	1	31.0	.0	37.3	33.2	.0	37.9	53.0	.0	40.0	43.2
							.0	.0	.0	.0	.0	.0	.0	.0	.0	.0
							207207	207207	222200	224200	210200	0	212200	0	0	0
							0	0	0	0	0	0	0	0	0	0
7	1	15.0	302.	15.	0	1	61.0	.0	43.7	64.8	.0	67.1	59.0	45.6	.0	.0
							.0	.0	.0	.0	.0	.0	.0	.0	.0	.0
							207207	207207	222200	224200	210200	0	212200	0	0	0
							0	0	0	0	0	0	0	0	0	0
7	101	14.6	302.	15.	0	1	50.4	.0	37.3	50.4	.0	61.1	53.0	.0	.0	.0
							.0	.0	.0	.0	.0	.0	.0	.0	.0	.0
							207207	207207	222200	224200	210200	0	212200	0	0	0
							0	0	0	0	0	0	0	0	0	0

DIST COPY 11/11/11

ZONE	CELL	EFF. POP.	MIL. COST (\$000'S)	PLN. AREA SQ. FT. (000'S)	CL	LND USE	SOURCES (1-10) / (11-20) / INDICATORS (1-10) / (11-20)									
							1	2	3	4	5	6	7	8	9	10
10	1	11.3	497.	10.	0	1	.0	.0	43.7	.0	.0	.0	59.0	.0	71.0	67.5
							47.8	.0	.0	.0	.0	.0	.0	.0	.0	.0
							207207	207207	222200	224200	210200	206200	212200	.0	.0	.0
							0	0	0	0	0	0	0	0	0	0
10	101	10.4	497.	10.	0	1	.0	.0	37.3	.0	.0	.0	53.0	.0	62.4	56.3
							40.2	.0	.0	.0	.0	.0	.0	.0	.0	.0
							207207	207207	222200	224200	210200	206200	212200	.0	.0	.0
							0	0	0	0	0	0	0	0	0	0
10	2	1.9	67.	3.	0	1	50.1	.0	43.7	53.0	.0	57.0	59.0	37.7	.0	.0
							.0	.0	.0	.0	.0	.0	.0	.0	.0	.0
							207207	207207	222200	224200	210200	.0	212200	.0	.0	.0
							0	0	0	0	0	0	0	0	0	0
10	102	1.9	67.	3.	0	1	44.1	.0	37.3	47.0	.0	51.0	53.0	.0	.0	.0
							.0	.0	.0	.0	.0	.0	.0	.0	.0	.0
							207207	207207	222200	224200	210200	.0	212200	.0	.0	.0
							0	0	0	0	0	0	0	0	0	0
11	1	6.3	322.	6.	0	1	58.0	.0	43.7	60.3	.0	66.0	59.0	50.7	.0	.0
							.0	.0	.0	.0	.0	.0	.0	.0	.0	.0
							207207	207207	222200	224200	210200	.0	212200	.0	.0	.0
							0	0	0	0	0	0	0	0	0	0
11	101	6.0	322.	6.	0	1	52.0	.0	37.3	54.3	.0	60.0	53.0	.0	.0	.0
							.0	.0	.0	.0	.0	.0	.0	.0	.0	.0
							207207	207207	222200	224200	210200	.0	212200	.0	.0	.0
							0	0	0	0	0	0	0	0	0	0
11	2	5.0	264.	6.	0	1	44.2	.0	43.7	52.0	.0	56.2	59.0	40.5	.0	.0
							.0	.0	.0	.0	.0	.0	.0	.0	.0	.0
							207207	207207	222200	224200	210200	.0	212200	.0	.0	.0
							0	0	0	0	0	0	0	0	0	0
11	102	4.9	264.	6.	0	1	43.2	.0	37.3	46.0	.0	50.2	53.0	.0	.0	.0
							.0	.0	.0	.0	.0	.0	.0	.0	.0	.0
							207207	207207	222200	224200	210200	.0	212200	.0	.0	.0
							0	0	0	0	0	0	0	0	0	0
12	1	142.5	1750.	50.	0	11	46.4	.0	43.7	46.6	.0	54.0	59.0	39.2	.0	.0
							.0	.0	.0	.0	.0	.0	.0	.0	.0	.0
							207207	207207	222200	224200	210200	.0	212200	.0	.0	.0
							0	0	0	0	0	0	0	0	0	0
12	101	.0	1750.	50.	0	11	40.4	.0	37.3	42.6	.0	48.0	53.0	.0	.0	.0
							.0	.0	.0	.0	.0	.0	.0	.0	.0	.0
							207207	207207	222200	224200	210200	.0	212200	.0	.0	.0
							0	0	0	0	0	0	0	0	0	0

PLOT COPY AVAILABLE

ZONE	CELL	EFF. POP.	MEL. COST (1000'S)	FLH. AREA (1000'S)	CL	LND USE	SOURCES (1-10) / (11-20) / INDICATORS (1-10) / (11-20)														
							1	2	3	4	5	6	7	8	9	10	11	12	13	14	15
15	3	136.0	5056.	201.	0	1	43.0	.0	43.7	48.5	.0	50.3	59.0	30.5	.0	.0	.0	.0	.0	.0	.0
							207207	207207	222200	224200	210200	0	212200	0	0	0	0	0	0	0	0
15	103	134.6	5056.	201.	0	1	37.0	.0	37.3	38.5	.0	44.3	53.0	.0	.0	.0	.0	.0	.0	.0	.0
							207207	207207	222200	224200	210200	0	212200	0	0	0	0	0	0	0	0
16	1	73.1	2661.	94.	0	4	.0	.0	43.7	.0	.0	.0	59.0	.0	71.0	62.4	.0	.0	.0	.0	.0
							207207	207207	222200	224200	210200	0	212200	0	0	0	0	0	0	0	0
16	101	71.6	2661.	94.	0	4	.0	.0	37.3	.0	.0	.0	53.0	.0	67.6	56.3	.0	.0	.0	.0	.0
							207207	207207	222200	224200	210200	0	212200	0	0	0	0	0	0	0	0
17	1	32.5	423.	30.	0	1	.0	.0	43.7	.0	.0	.0	59.0	.0	65.9	61.9	.0	.0	.0	.0	.0
							207207	207207	222200	224200	210200	0	212200	0	0	0	0	0	0	0	0
17	101	32.2	423.	30.	0	1	.0	.0	37.3	.0	.0	.0	53.0	.0	61.1	57.1	.0	.0	.0	.0	.0
							207207	207207	222200	224200	210200	0	212200	0	0	0	0	0	0	0	0
17	2	36.2	437.	30.	0	1	55.6	57.9	43.7	55.2	62.0	64.4	59.0	.0	92.7	40.0	.0	.0	.0	.0	.0
							207207	207207	222200	224200	210200	0	212200	0	0	0	0	0	0	0	0
17	102	35.6	437.	30.	0	1	50.6	52.4	37.3	50.2	56.0	58.4	53.0	.0	87.9	45.2	.0	.0	.0	.0	.0
							207207	207207	222200	224200	210200	0	212200	0	0	0	0	0	0	0	0
18	1	21.2	924.	27.	0	1	62.1	.0	43.7	65.5	.0	66.2	59.0	50.8	.0	.0	.0	.0	.0	.0	.0
							207207	207207	222200	224200	210200	0	212200	0	0	0	0	0	0	0	0
18	101	20.6	924.	27.	0	1	56.1	.0	37.3	59.5	.0	62.2	53.0	.0	.0	.0	.0	.0	.0	.0	.0
							207207	207207	222200	224200	210200	0	212200	0	0	0	0	0	0	0	0

REPORT NUMBER: 1000000000

ZONE CELL EFF. PDP. REL. COSI (1000'S) FLH. AREA SQ. FT. (1000'S) CL LAD USE

SOURCES (1-10) / (11-20) / INDICATORS (1-10) / (11-20)

ZONE	CELL	EFF. PDP.	REL. COSI (1000'S)	FLH. AREA SQ. FT. (1000'S)	CL	LAD USE	SOURCE 1	SOURCE 2	SOURCE 3	SOURCE 4	SOURCE 5	INDICATOR 1	INDICATOR 2	INDICATOR 3	INDICATOR 4	INDICATOR 5
18	2	24.4	657.	33.	0	1	41.7	.0	43.7	43.8	.0	49.3	59.0	35.9	.0	.0
							207207	207207	222200	224200	210200	0	212200	0	0	0
18	102	24.4	657.	33.	0	1	35.7	.0	37.3	37.8	.0	43.3	53.0	.0	.0	.0
							207207	207207	222200	224200	210200	0	212200	0	0	0
19	1	142.5	1750.	50.	0	11	40.0	.0	43.7	42.1	.0	47.6	59.0	.0	.0	.0
							207207	207207	222200	224200	210200	0	212200	0	0	0
19	101	.0	1750.	50.	0	11	34.0	.0	37.3	36.1	.0	41.6	53.0	.0	.0	.0
							207207	207207	222200	224200	210200	0	212200	0	0	0
20	1	10.6	266.	16.	0	4	67.2	69.5	43.7	66.5	73.3	74.2	59.0	.0	.0	.0
							207207	207207	222200	224200	210200	0	212200	0	0	0
20	101	10.9	266.	16.	0	4	61.2	63.5	37.3	60.5	67.3	66.2	53.0	.0	.0	.0
							207207	207207	222200	224200	210200	0	212200	0	0	0
21	1	49.4	1097.	50.	0	1	67.2	69.5	43.7	66.5	73.3	74.2	59.0	45.9	.0	.0
							207207	207207	222200	224200	210200	0	212200	0	0	0
21	101	40.7	1097.	50.	0	1	62.2	63.5	37.3	60.5	67.3	66.2	53.0	.0	.0	.0
							207207	207207	222200	224200	210200	0	212200	0	0	0
21	2	73.1	1620.	66.	0	1	55.0	57.9	43.7	55.6	62.0	62.9	59.0	35.9	.0	.0
							207207	207207	222200	224200	210200	0	212200	0	0	0
21	102	71.6	1620.	66.	0	1	49.0	51.9	37.3	49.6	56.0	56.9	53.0	.0	.0	.0
							207207	207207	222200	224200	210200	0	212200	0	0	0

BEST COPY AVAILABLE

ZONE	CELL	EFF. POP.	REL. COST (1000'S)	PLM. AREA SQ. FT. (1000'S)	CL	LNU USE	SOURCES (1-10) / (11-20) /					INDICATORS (1-10) / (11-20)					
							1	2	3	4	5	6	7	8	9	10	11
21	J	36.9	993.	44.	0	1	52.5	54.3	43.7	57.6	58.4	60.5	59.0	38.2	.0	.0	.0
							207207	207207	222200	224200	210200	0	212200	0	0	0	0
21	103	36.0	993.	40.	0	1	46.5	46.8	37.3	46.6	52.4	54.5	53.0	.0	.0	.0	
							207207	207207	222200	224200	210200	0	212200	0	0	0	0
22	1	70.7	950.	60.	0	1	67.2	69.5	43.7	66.5	71.3	74.2	59.0	.0	.0	.0	
							207207	207207	222200	224200	210200	0	212200	0	0	0	0
22	101	77.6	950.	60.	0	1	61.2	61.5	37.3	60.5	67.3	60.2	53.0	.0	.0	.0	
							207207	207207	222200	224200	210200	0	212200	0	0	0	0
22	2	70.1	1010.	75.	0	1	57.1	57.9	43.7	58.3	62.0	64.0	59.0	35.5	.0	.0	
							207207	207207	222200	224200	210200	0	212200	0	0	0	0
22	102	76.9	1010.	75.	0	1	51.1	51.9	37.3	52.3	56.0	50.0	53.0	.0	.0	.0	
							207207	207207	222200	224200	210200	0	212200	0	0	0	0
21	1	142.5	1750.	50.	0	11	60.6	62.9	43.7	60.2	67.0	67.7	59.0	.0	.0	.0	
							207207	207207	222200	224200	210200	0	212200	0	0	0	0
21	101	.0	1750.	50.	0	11	54.6	56.9	37.3	54.2	63.0	61.7	53.0	.0	.0	.0	
							207207	207207	222200	224200	210200	0	212200	0	0	0	0

PRINT NAME: 11/11/11

TITLE- DATA SET:
JOB DESCRIPTION:

MENLO PARK, SAN FRANCISCO BAY REGION STUDY AREA II, 1981 POPULATION, 1976 COSTS.
STUDY AREA II LOW COST FUNCTIONS, NEW AUTOMOB. CASE 3, AUTO METHOD II CASE 2.

CM -0-0

SA II COUNTERMEASURE DEFINITIONS

***** AUTOMOBILES LOW SPEED NEW VEHICLES SOURCE REDUCTION
COUNTERMEASURE 1 TYPE 15 'EXCL TR1' APPLIES TO: AUTOMOBILES LOW SPEED LINE SRC INDICATOR NO. 1
AUTOMOBILES LOCAL TRAFFIC SOURCE -0

***** AUTOMOBILES LOW SPEED ODS ENFORCEMENT
COUNTERMEASURE 2 TYPE 12 'ODS RED' APPLIES TO: AUTOMOBILES LOW SPEED LINE SRC INDICATOR NO. -0
AUTOMOBILES LOCAL TRAFFIC SOURCE -0

***** AUTOMOBILES LOW SPEED EXISTING VEHICLES METHOD II SOURCE REDUCTION
COUNTERMEASURE 3 TYPE 15 'EXCL TR1' APPLIES TO: AUTOMOBILES LOW SPEED LINE SRC INDICATOR NO. 2
AUTOMOBILES LOCAL TRAFFIC SOURCE -0

***** TRUCKS LOW SPEED NEW VEHICLES SOURCE REDUCTION
COUNTERMEASURE 4 TYPE 15 'EXCL TR1' APPLIES TO: TRUCKS LOW SPEED LINE SRC. INDICATOR NO. 3

***** TRUCKS LOW SPEED ODS ENFORCEMENT AND METHOD II SOURCE REDUCTION
COUNTERMEASURE 5 TYPE 15 'EXCL TR1' APPLIES TO: TRUCKS LOW SPEED LINE SRC. INDICATOR NO. 4

***** TRUCKS HIGH SPEED TIME NOISE REDUCTION
COUNTERMEASURE 6 TYPE 10 'PART TR1' APPLIES TO: TRUCKS HIGH SPEED LINE SRC. INDICATOR NO. 5

***** BUSES LOW SPEED SOURCE REDUCTION, NEW AND EXISTING VEHICLES
COUNTERMEASURE 7 TYPE 12 'ODS RED' APPLIES TO: BUSES LOW SPEED LINE SRC. INDICATOR NO. -0

***** MOTORCYCLES LOW SPEED ODS ENFORCEMENT
COUNTERMEASURE 8 TYPE 12 'ODS RED' APPLIES TO: MOTORCYCLES LOW SPEED LINE SRC. INDICATOR NO. -0
MOTORCYCLES LOCAL TRAFFIC SOURCE -0

***** AIRCRAFT SOUND ABSORPTION MATERIAL WALL TREATMENT SOURCE REDUCTION
COUNTERMEASURE 9 TYPE 10 'PART TR1' APPLIES TO: AIRCRAFT COMMERCIAL, FLIGHT INDICATOR NO. 6

***** AIRCRAFT FLIGHT PATH REQUIRING (EFFECTIVELY A FLIGHT FREQUENCY RED.)
COUNTERMEASURE 10 TYPE 1 'RED FREQ' APPLIES TO: AIRCRAFT COMMERCIAL, FLIGHT INDICATOR NO. -0

----- AIRCRAFT REDUCTION OF NIGHT OPERATIONS
COUNTERMEASURE 11 TYPE 3 'NITE HED' APPLIES TO: AIRCRAFT COMMERCIAL, FLIGHT INDICATOR NO. -0

----- RAILROAD LOCOMOTIVE MUFFLERS, SOURCE REDUCTION
COUNTERMEASURE 12 TYPE 10 'PAK1 INT' APPLIES TO: RAILROAD LOCOMOTIVES, LINE 9. INDICATOR NO. 7

----- PATH-RECEIVER CONTROL, INSULATION, BARRIERS, LAND ACQ. AND PEOPLE RELOC.
COUNTERMEASURE 13 TYPE 20 'P-R MOD' APPLIES TO: ALL SOURCES INDICATOR NO. -0

 TITLE- DATA SET:
 JOB DESCRIPTION:

MENLO PARK, SAN FRANCISCO BAY REGION STUDY AREA II, 1981 POPULATION, 1976 COSTS,
 STUDY AREA II LOW COST FUNCTIONS, NEW AUTOMOB. CASE 3, AUTO RETROFIT CASE 2.

 COST -0-0 SA II (MENLO PARK) LOW COST FUNCTIONS

----- COST FUNCTION FOR AUTOMOBILES LOW SPEED NEW VEHICLES SOURCE RED., CASE 3
 FEASIBLE RANGE OF CM VARIABLE: .000 TO .432
 NOISE RED PARAMETER: .00 .10 .20 .30 .41 -.00 -.00 -.00
 CORRESPONDING COSTS: .00 14.31 47.72 162.23 240.12 -.00 -.00 -.00

----- COST FUNCTION FOR AUTOMOBILES LOW SPEED ODS ENFORCEMENT
 FEASIBLE RANGE OF CM VARIABLE: .000 TO 6.200
 NOISE RED PARAMETER: .00 4.50 5.50 5.00 6.20 -.00 -.00 -.00
 CORRESPONDING COSTS: .00 .25 .76 3.12 12.44 -.00 -.00 -.00

----- COST FUNCTION FOR AUTOMOBILES LOW SP. EXIST. VEH. RETROFIT, CASE 2
 FEASIBLE RANGE OF CM VARIABLE: .000 TO .560
 NOISE RED PARAMETER: .00 .21 .38 .51 .57 -.00 -.00 -.00
 CORRESPONDING COSTS: .00 .06 .21 .73 1.11 -.00 -.00 -.00

----- COST FUNCTION FOR TRUCKS LOW SPEED NEW VEH. SOURCE REDUCTION
 FEASIBLE RANGE OF CM VARIABLE: .000 TO .436
 NOISE RED PARAMETER: .00 .20 .33 .41 .44 -.00 -.00 -.00
 CORRESPONDING COSTS: .00 31.01 63.62 143.15 222.67 -.00 -.00 -.00

----- COST FUNCTION FOR TRUCKS LOW SPEED ODS ENFORCEMENT AND RETROFIT SOURCE A
 FEASIBLE RANGE OF CM VARIABLE: .000 TO .560
 NOISE RED PARAMETER: .00 .13 .41 .51 .56 -.00 -.00 -.00
 CORRESPONDING COSTS: .00 .09 4.00 32.00 143.00 -.00 -.00 -.00

----- COST FUNCTION FOR TRUCKS HI SPEED TIRE NOISE REDUCTION
 FEASIBLE RANGE OF CM VARIABLE: .000 TO 1.000
 NOISE RED PARAMETER: .00 1.00 -.00 -.00 -.00 -.00 -.00 -.00
 CORRESPONDING COSTS: .00 42.00 -.00 -.00 -.00 -.00 -.00 -.00

----- COST FUNCTION FOR BUSES LOW SP. SOURCE RED., NEW AND EXIST. VEHICLES
 FEASIBLE RANGE OF CM VARIABLE: .000 TO 6.700
 NOISE RED PARAMETER: .00 .25 2.35 6.70 -.00 -.00 -.00
 CORRESPONDING COSTS: .00 .03 1.78 16.22 -.00 -.00 -.00

FIRST PRINTED 1981

----- COST FUNCTION FOR MOTORCYCLES LOW SPEED ODS ENFORCEMENT

FEASIBLE RANGE OF CM VARIABLES	.000 TO	17.000						
NOISE RED PARAMETERS	.00	5.04	9.46	12.75	17.00	-.00	-.00	-.00
CORRESPONDING COSTS:	.00	.02	.06	.16	.50	-.00	-.00	-.00

----- COST FUNCTION FOR AIRCRAFT OAS SOURCE REDUCTION

FEASIBLE RANGE OF CM VARIABLES	.000 TO	1.000						
NOISE RED PARAMETERS	.00	1.00	-.00	-.00	-.00	-.00	-.00	-.00
CORRESPONDING COSTS:	.00	14.26	-.00	-.00	-.00	-.00	-.00	-.00

----- COST FUNCTION FOR AIRCRAFT FLIGHT PATH REHOUSING (FREQ. REDUCTION)

FEASIBLE RANGE OF CM VARIABLES	.000 TO	1.000						
NOISE RED PARAMETERS	.00	1.00	-.00	-.00	-.00	-.00	-.00	-.00
CORRESPONDING COSTS:	.00	9.07	-.00	-.00	-.00	-.00	-.00	-.00

----- COST FUNCTION FOR AIRCRAFT NIGHT OPERATIONS REDUCTION

FEASIBLE RANGE OF CM VARIABLES	.000 TO	1.000						
NOISE RED PARAMETERS	.00	1.00	-.00	-.00	-.00	-.00	-.00	-.00
CORRESPONDING COSTS:	.00	32.76	-.00	-.00	-.00	-.00	-.00	-.00

----- COST FUNCTION FOR LOCOMOTIVE MUFFLERS, SOURCE REDUCTION

FEASIBLE RANGE OF CM VARIABLES	.000 TO	1.000						
NOISE RED PARAMETERS	.00	1.00	-.00	-.00	-.00	-.00	-.00	-.00
CORRESPONDING COSTS:	.00	16.22	-.00	-.00	-.00	-.00	-.00	-.00

SUMMARY OF ALLOWED COST RANGES (\$000'S)

COUNTERMEASURE NUMBER	RANGE	
1	\$.00 TO \$	246.12
2	\$.00 TO \$	12.44
3	\$.00 TO \$	1.11
4	\$.00 TO \$	-222.67
5	\$.00 TO \$	143.00
6	\$.00 TO \$	92.09
7	\$.00 TO \$	16.22
8	\$.00 TO \$.50
9	\$.00 TO \$	19.28
10	\$.00 TO \$	9.07
11	\$.00 TO \$	32.76
12	\$.00 TO \$	16.22

 TITLE- DATA SET:
 JOB DESCRIPTION:

MENLO PARK, SAN FRANCISCO BAY REGION STUDY AREA II, 1981 POPULATION, 1976 COSTS,
 STUDY AREA II LOW COST FUNCTION, AREA AUTOMOBILE CASE 3, AUTO RETROFIT CASE 2.

 BAR -0-0

BARRIER DATA SA II LOW COST

----- BARRIERS FOR STUDY AREA II (MENLO PARK), LOW COST

BARRIER EFFECTIVENESS RATIOS:

		LOW	HIGH
1	AUTOMOBILES LOW SPEED LINE SRC	1.25	1.50
2	AUTOMOBILES HIGH SPEED LINE SRC	1.25	1.50
4	TRUCKS LOW SPEED LINE SRC	1.00	1.40
5	TRUCKS HIGH SPEED LINE SRC	1.10	1.50
6	MOTORCYCLES LOW SPEED LINE SRC	1.25	1.50
8	BUSES LOW SPEED LINE SRC	1.00	1.40
9	RAILROAD LOCOMOTIVES, LINE S.	.50	1.00
10	RAILROAD CARS, LINE SOURCE	1.50	1.40

*NBR *	COSTS (-\$1000'S)		PRIMARY CELL			SECONDARY CELLS -->								
	HI 1	HI 2 *	ID	DB1	DB2 *	ID	DB1	DB2 *	ID	DB1	DB2 *			
* 1 *	37.6	55.0 *	23	1	0.0	0.0 *	-0	-0	-0.0	-0.0 *	-0	-0	-0.0	-0.0 *
* 2 *	167.2	248.4 *	22	1	10.0	10.0 *	22	2	0.0	0.0 *	-0	-0	-0.0	-0.0 *
* 3 *	167.2	248.4 *	21	1	10.0	10.0 *	21	2	0.0	0.0 *	21	3	0.0	0.0 *
* 4 *	31.9	77.1 *	20	1	10.0	10.0 *	-0	-0	-0.0	-0.0 *	-0	-0	-0.0	-0.0 *
* 6 *	192.9	289.7 *	6	1	10.0	10.0 *	6	2	0.0	0.0 *	-0	-0	-0.0	-0.0 *
* 7 *	505.3	758.0 *	17	1	10.0	10.0 *	17	2	0.0	0.0 *	-0	-0	-0.0	-0.0 *
* 8 *	257.0	386.0 *	10	1	10.0	10.0 *	-0	-0	-0.0	-0.0 *	-0	-0	-0.0	-0.0 *
* 9 *	432.7	649.9 *	9	1	10.0	10.0 *	9	2	0.0	0.0 *	-0	-0	-0.0	-0.0 *
* 10 *	171.3	257.3 *	16	1	10.0	10.0 *	-0	-0	-0.0	-0.0 *	-0	-0	-0.0	-0.0 *

TITLE- DATA SET:
JOB DESCRIPTION:

MENLO PARK, SAN FRANCISCO BAY REGION STUDY AREA II, 1981 POPULATION, 1976 COSTS.
STUDY AREA II LOW COST FUNCTIONS, NEW AUTOMOB. CASE 3, AUTO RETROFIT CASE 2.

PAGE -0-0

----- SOUNDPROOFING DATA SA II (MENLO PARK), LOW COST ESTIMATES; ALL PR OPTION

P/R MOD OVERRIDE ARRAY:
1 1 1 1 1 1 1 1 1 1

RESIDENTIAL SOUNDPROOFING AND COST FACTORS (\$/SQ FT):

5 DB	10 DB	15 DB
2.25	6.44	11.60

COMMERCIAL SOUNDPROOFING AND COST FACTORS (\$/SQ FT):

5 DB	10 DB	15 DB
2.25	6.44	11.60

TITLE- DATA SET:
JOB DESCRIPTION:

MENLO PARK, SAN FRANCISCO BAY REGION STUDY AREA II, 1961 POPULATION, 1976 COSTS,
STUDY AREA II LOW COST FUNCTIONS, NEA AUTOMOB, CASE 3, AUTO RETROFIT CASE 2.

CHIT -0.3

ALLOW MORE THAN 100 PERC. ADV. EFFECT

TRANSFER FUNCTION TYPE 1 IN EFFECT WITH BULGE FACTOR OF 1.00

LINEAR FUNCTION ALLOWING MORE THAN 100 PERCENT ADVERSE EFFECT

TITLE- DATA SET
JOB DESCRIPTION

MENLO PARK, SAN FRANCISCO BAY REGION STUDY AREA 11, 1981 POPULATION, 1976 COSTS.
STUDY AREA 11 LOW COST FUNCTIONS, NE AUTUMN, CASE 3, AUTO RETROFIT CASE 2.

CH11 0 0

TRANSF.CT. FOR SFU STUDY, 20 DB RANGE

LOWER CRITERION LEVELS OF 60 CELLS TYPE 1 CHANGED TO 57 DBA(D) AND 49 DBA(N)
LOWER CRITERION LEVELS OF 6 CELLS TYPE 4 CHANGED TO 62 DBA(D) AND 49 DBA(N)
LOWER CRITERION LEVELS OF 2 CELLS TYPE 5 CHANGED TO 62 DBA(D) AND 62 DBA(N)
LOWER CRITERION LEVELS OF 0 CELLS TYPE 6 CHANGED TO 70 DBA(D) AND 70 DBA(N)
LOWER CRITERION LEVELS OF 8 CELLS TYPE 11 CHANGED TO 57 DBA(D) AND 40 DBA(N)
LOWER CRITERION LEVELS OF 2 CELLS TYPE 12 CHANGED TO 60 DBA(D) AND 57 DBA(N)

UPPER CRITERION LEVELS OF ALL CELLS TYPE 1 CHANGED TO 77 DBA(D) AND 69 DBA(N)
UPPER CRITERION LEVELS OF ALL CELLS TYPE 2 CHANGED TO 0 DBA(D) AND 0 DBA(N)
UPPER CRITERION LEVELS OF ALL CELLS TYPE 3 CHANGED TO 0 DBA(D) AND 0 DBA(N)
UPPER CRITERION LEVELS OF ALL CELLS TYPE 4 CHANGED TO 82 DBA(D) AND 69 DBA(N)
UPPER CRITERION LEVELS OF ALL CELLS TYPE 5 CHANGED TO 82 DBA(D) AND 82 DBA(N)
UPPER CRITERION LEVELS OF ALL CELLS TYPE 6 CHANGED TO 0 DBA(D) AND 0 DBA(N)
UPPER CRITERION LEVELS OF ALL CELLS TYPE 7 CHANGED TO 0 DBA(D) AND 0 DBA(N)
UPPER CRITERION LEVELS OF ALL CELLS TYPE 8 CHANGED TO 90 DBA(D) AND 90 DBA(N)
UPPER CRITERION LEVELS OF ALL CELLS TYPE 9 CHANGED TO 0 DBA(D) AND 0 DBA(N)
UPPER CRITERION LEVELS OF ALL CELLS TYPE 10 CHANGED TO 0 DBA(D) AND 0 DBA(N)
UPPER CRITERION LEVELS OF ALL CELLS TYPE 11 CHANGED TO 77 DBA(D) AND 0 DBA(N)
UPPER CRITERION LEVELS OF ALL CELLS TYPE 12 CHANGED TO 60 DBA(D) AND 77 DBA(N)
UPPER CRITERION LEVELS OF ALL CELLS TYPE 13 CHANGED TO 0 DBA(D) AND 0 DBA(N)
UPPER CRITERION LEVELS OF ALL CELLS TYPE 14 CHANGED TO 0 DBA(D) AND 0 DBA(N)
UPPER CRITERION LEVELS OF ALL CELLS TYPE 15 CHANGED TO 0 DBA(D) AND 0 DBA(N)

NOTE: This example case did not use the suggested criterion levels from Table 2-2.

ZONE	CELL	EFF. POP.	HEL. CUST. (5000'S)	FLR. AREA (000'S)	NO. FT. CL	LND USE	SOURCES (1-10) / (11-20) / INDICATORS (1-10) / (11-20)													
							1	2	3	4	5	6	7	8	9	10	11	12	13	14
1	1	142.5	1750.	50.	57	11	52.0	.0	44.2	52.2	.0	56.5	61.4	37.3	.0	.0				
							52.0	.0	.0	.0	.0	.0	.0	.0	.0	.0	.0	.0		
							207207	207207	222200	224200	210200	206200	212200	0	0	0	0	0		
1	101	.0	1750.	50.	0	11	46.0	.0	42.0	46.2	.0	50.5	55.4	.0	.0					
							45.5	.0	.0	.0	.0	.0	.0	.0	.0					
							207207	207207	222200	224200	210200	212200	212200	0	0	0				
2	1	3.0	66.	4.	62	4	62.0	.0	49.2	63.4	.0	65.0	61.4	.0	.0					
							52.0	.0	.0	.0	.0	.0	.0	.0	.0	.0				
							207207	207207	222200	224200	210200	206200	212200	0	0	0	0			
2	101	3.0	66.	4.	49	4	56.0	.0	42.0	57.4	.0	59.0	55.4	.0	.0					
							45.0	.0	.0	.0	.0	.0	.0	.0	.0					
							207207	207207	222200	224200	210200	212200	212200	0	0	0				
3	1	168.09999999	350.	62	5	5	54.1	.0	49.2	58.5	.0	57.2	61.4	31.4	61.5	52.7				
							48.3	.0	.0	.0	.0	.0	.0	.0	.0	.0				
							207207	207207	222200	224200	210200	206200	212200	0	0	0	0			
3	101	5.69999999	350.	62	5	5	48.1	.0	42.0	52.5	.0	50.5	55.4	.0	57.4	47.2				
							40.5	.0	.0	.0	.0	.0	.0	.0	.0					
							207207	207207	222200	224200	210200	206200	212200	0	0	0				
4	1	20.6	235.	15.	57	1	57.3	.0	49.2	57.5	.0	62.1	61.4	45.6	.0	.0				
							52.5	.0	.0	.0	.0	.0	.0	.0	.0	.0				
							207207	207207	222200	224200	210200	206200	212200	0	0	0	0			
4	101	20.3	235.	15.	49	1	51.1	.0	42.0	51.5	.0	56.1	55.4	.0	.0					
							45.1	.0	.0	.0	.0	.0	.0	.0	.0					
							207207	207207	222200	224200	210200	212200	212200	0	0	0				
4	2	26.9	317.	21.	57	1	44.0	.0	49.2	44.7	.0	49.2	61.4	32.6	55.2	51.2				
							52.5	.0	.0	.0	.0	.0	.0	.0	.0	.0				
							207207	207207	222200	224200	210200	206200	212200	0	0	0	0			
4	102	26.3	317.	21.	49	1	50.6	.0	42.0	16.7	.0	43.2	55.4	.0	50.4	46.4				
							45.3	.0	.0	.0	.0	.0	.0	.0	.0					
							207207	207207	222200	224200	210200	214200	212200	0	0	0				

ZONE	CELL	EFF. POP.	REL. COST (\$000'S)	FLH. AREA SQ. FT. (000'S)	CL	LND USE	SOURCES (1-10) / (11-20) / INDICATORS (1-10) / (11-20)									
							1	2	3	4	5	6	7	8	9	10
5	1	51.0	1319.	79.	57	1	66.3	.0	49.2	67.8	.0	69.4	61.8	45.6	.0	.0
							51.0	.0	.0	.0	.0	.0	.0	.0	.0	.0
							207207	207207	222200	224200	210200	200200	212200	0	0	0
							0	0	0	0	0	0	0	0	0	0
5	101	51.0	1319.	79.	49	1	60.3	.0	42.8	61.8	.0	63.4	55.4	.0	.0	.0
							45.0	.0	.0	.0	.0	.0	.0	.0	.0	.0
							207207	207207	222200	224200	210200	210200	212200	0	0	0
							0	0	0	0	0	0	0	0	0	0
5	2	41.3	922.	45.	57	1	46.6	.0	49.2	46.8	.0	51.2	61.4	35.6	.0	.0
							.0	.0	.0	.0	.0	.0	.0	.0	.0	.0
							207207	207207	222200	224200	210200	0	212200	0	0	0
							0	0	0	0	0	0	0	0	0	0
5	102	40.1	922.	45.	49	1	40.6	.0	42.8	40.8	.0	45.2	55.4	.0	.0	.0
							.0	.0	.0	.0	.0	.0	.0	.0	.0	.0
							207207	207207	222200	224200	210200	0	212200	0	0	0
							0	0	0	0	0	0	0	0	0	0
6	1	26.1	510.	29.	57	1	54.0	.0	49.2	55.1	.0	59.0	61.4	45.2	65.7	61.7
							.0	.0	.0	.0	.0	.0	.0	.0	.0	.0
							207207	207207	222200	224200	210200	0	212200	0	0	0
							0	0	0	0	0	0	0	6100	6100	6100
6	101	27.0	510.	29.	49	1	48.6	.0	42.8	49.1	.0	53.0	55.4	.0	60.9	56.4
							.0	.0	.0	.0	.0	.0	.0	.0	.0	.0
							207207	207207	222200	224200	210200	0	212200	0	0	0
							0	0	0	0	0	0	0	6100	6100	6100
6	2	9.4	151.	8.	57	1	42.5	.0	49.2	42.7	.0	46.3	61.4	.0	52.7	47.9
							.0	.0	.0	.0	.0	.0	.0	.0	.0	.0
							207207	207207	222200	224200	210200	0	212200	0	0	0
							0	0	0	0	0	0	0	6080	6080	6080
6	102	9.0	151.	8.	49	1	36.5	.0	42.8	36.7	.0	40.3	55.4	.0	40.0	43.2
							.0	.0	.0	.0	.0	.0	.0	.0	.0	.0
							207207	207207	222200	224200	210200	0	212200	0	0	0
							0	0	0	0	0	0	0	6080	6080	6080
7	1	15.0	302.	15.	57	1	66.5	.0	49.2	67.9	.0	69.5	61.4	45.6	.0	.0
							.0	.0	.0	.0	.0	.0	.0	.0	.0	.0
							207207	207207	222200	224200	210200	0	212200	0	0	0
							0	0	0	0	0	0	0	0	0	0
7	101	14.6	302.	15.	49	1	63.9	.0	42.8	61.9	.0	63.5	55.4	.0	.0	.0
							.0	.0	.0	.0	.0	.0	.0	.0	.0	.0
							207207	207207	222200	224200	210200	0	212200	0	0	0
							0	0	0	0	0	0	0	0	0	0

ZONE	CELL	EFF. POP.	HEL. CUST (3000'S)	FLH. AREA SQ. FT. (1000'S)	CL	LND USE	SOURCES (1-10) / (11-20) / INDICATORS (1-10) / (11-20)																			
							1	2	3	4	5	6	7	8	9	10	11	12	13	14						
7	2	25.6	504.	29.	57	1	45.4	.0	49.2	45.6	.0	49.7	61.4	35.6	.0	.0	207207	207207	222200	224200	210200	.0	212200	.0	.0	.0
7	102	25.1	504.	29.	49	1	39.4	.0	42.8	39.6	.0	43.7	55.4	.0	.0	.0	207207	207207	222200	224200	210200	.0	212200	.0	.0	.0
8	1	82.5	1176.	79.	57	1	69.4	.0	49.2	67.4	.0	72.3	61.4	45.6	.0	.0	207207	207207	222200	224200	210200	206200	212200	.0	.0	.0
8	101	81.4	1176.	79.	49	1	63.0	.0	42.8	61.4	.0	66.3	55.4	.0	.0	.0	207207	207207	222200	224200	210200	210200	212200	.0	.0	.0
8	2	11.3	209.	12.	57	1	57.2	.0	49.2	58.8	.0	66.2	61.4	32.6	.0	.0	207207	207207	222200	224200	210200	206200	212200	.0	.0	.0
8	102	10.9	209.	12.	49	1	51.2	.0	42.8	52.8	.0	60.2	55.4	.0	.0	.0	207207	207207	222200	224200	210200	210200	212200	.0	.0	.0
9	1	51.9	1759.	62.	57	1	.0	.0	49.2	.0	.0	.0	61.4	.0	71.0	62.4	207207	207207	222200	224200	210200	206200	212200	.0	.0	.0
9	101	51.0	1759.	62.	49	1	.0	.0	42.8	.0	.0	.0	55.4	.0	67.6	56.3	207207	207207	222200	224200	210200	206200	212200	.0	.0	.0
9	2	16.9	400.	24.	57	1	54.0	.0	49.2	55.6	.0	57.2	61.4	32.6	61.6	53.5	207207	207207	222200	224200	210200	206200	212200	.0	.0	.0
9	102	16.9	400.	24.	49	1	40.0	.0	42.8	49.6	.0	51.2	55.4	.0	59.6	47.4	207207	207207	222200	224200	210200	212200	212200	.0	.0	.0

BEST COPY AVAILABLE

ZONE	CELL	EFF. POP.	REL. COST (1000'S)	FLH. AREA (1000'S)	SU. FT. CL	LND USE	SOURCES (I-10) / (II-20) / INDICATORS (I-10) / (II-20)									
							01.1	02.1	03.1	04.1	05.1	06.1	07.1	08.1	09.1	10.1
13	1	44.4	1766.	55.	57	1	61.1	0	49.2	61.6	0	66.1	61.4	40.9	0	0
							207207	207207	222200	224200	210200	0	212200	0	0	0
13	101	43.5	1766.	55.	49	1	54.1	0	42.8	55.6	0	60.1	55.4	0	0	0
							207207	207207	222200	224200	210200	0	212200	0	0	0
13	2	15.0	550.	16.	57	1	51.2	0	49.2	51.4	0	55.6	61.4	37.7	0	0
							207207	207207	222200	224200	210200	0	212200	0	0	0
13	102	14.6	550.	16.	49	1	45.2	0	42.8	45.8	0	49.6	55.4	0	0	0
							207207	207207	222200	224200	210200	0	212200	0	0	0
14	1	213.1	40000.	800.	60	12	54.5	49.2	49.2	54.0	53.3	50.1	61.4	33.4	0	0
							207207	207207	222200	224200	210200	0	212200	0	0	0
14	101	100.4	40000.	800.	57	12	46.5	43.2	42.8	46.0	47.3	52.3	55.4	0	0	0
							207207	207207	222200	224200	210200	0	212200	0	0	0
15	1	16.3	692.	23.	57	1	59.1	0	49.2	59.6	0	66.1	61.4	40.5	0	0
							207207	207207	222200	224200	210200	0	212200	0	0	0
15	101	16.1	692.	23.	49	1	53.1	0	42.8	53.6	0	50.1	55.4	0	0	0
							207207	207207	222200	224200	210200	0	212200	0	0	0
15	2	16.9	579.	21.	57	1	56.7	0	49.2	56.3	0	59.6	61.4	40.5	0	0
							207207	207207	222200	224200	210200	0	212200	0	0	0
15	102	16.5	579.	21.	49	1	50.7	0	42.8	50.3	0	53.6	55.4	0	0	0
							207207	207207	222200	224200	210200	0	212200	0	0	0

REPORT GENERATED BY...

ZONE	CELL	EFF. POP.	REL. CUSE (1000'S)	FLW. AREA SQ. FT. (1000'S)	CL	LND USE	SOURCES (I-10) / (II-20) / INDICATORS (I-10) / (II-20)									
							47.2	.0	44.2	47.3	.0	51.7	61.4	35.9	.0	.0
18	2	24.4	657.	33.	57	1	207207	207207	222200	224200	210200	0	212200	0	0	0
18	102	24.4	657.	33.	49	1	207207	207207	222200	224200	210200	0	212200	0	0	0
19	1	142.5	1750.	50.	57	11	207207	207207	222200	224200	210200	0	212200	0	0	0
19	101	.0	1750.	50.	0	11	207207	207207	222200	224200	210200	0	212200	0	0	0
20	1	10.6	260.	16.	62	4	207207	207207	222200	224200	210200	0	212200	0	4100	4100
20	101	10.9	260.	16.	40	4	207207	207207	222200	224200	210200	0	212200	0	4100	4100
21	1	49.0	1097.	50.	57	1	207207	207207	222200	224200	210200	0	212200	0	3100	3100
21	101	46.7	1097.	50.	49	1	207207	207207	222200	224200	210200	0	212200	0	3100	3100
21	2	75.1	1620.	60.	57	1	207207	207207	222200	224200	210200	0	212200	0	3000	3000
21	102	71.6	1620.	60.	49	1	207207	207207	222200	224200	210200	0	212200	0	3000	3000

DEPT CIVIL ENGINEERING

ZONE	CELL	EFF. POP.	REL. COST (1000'S)	FLW. AREA SQ. FT. (100'S)	CL	LND USE	SOURCES (1-10) / (11-20) / INDICATIONS (1-10) / (11-20)									
							1	2	3	4	5	6	7	8	9	10
21	3	36.0	993.	48.	57	1	58.0	54.3	49.2	56.1	54.4	62.9	61.8	38.2	.0	.0
							207207	207207	222200	224200	210200	.0	212200	.0	.0	.0
							0	0	0	0	0	0	0	0	3060	3060
21	103	36.0	993.	48.	49	1	52.0	48.3	42.8	50.1	52.0	56.9	55.8	.0	.0	.0
							207207	207207	222200	224200	210200	.0	212200	.0	.0	.0
							0	0	0	0	0	0	0	0	3060	3060
22	1	70.7	950.	48.	57	1	72.7	69.5	49.2	70.0	73.3	76.8	61.8	.0	.0	.0
							207207	207207	222200	224200	210200	.0	212200	.0	.0	.0
							0	0	0	0	0	0	0	0	2100	2100
22	101	77.6	950.	48.	49	1	66.7	65.5	42.8	64.0	67.3	70.6	55.8	.0	.0	.0
							207207	207207	222200	224200	210200	.0	212200	.0	.0	.0
							0	0	0	0	0	0	0	0	2100	2100
22	2	70.1	1018.	73.	57	1	62.6	57.9	49.2	61.8	62.0	66.8	61.4	35.5	.0	.0
							207207	207207	222200	224200	210200	.0	212200	.0	.0	.0
							0	0	0	0	0	0	0	0	2000	2000
22	102	76.9	1018.	73.	49	1	56.6	51.9	42.8	55.8	56.0	60.4	55.8	.0	.0	.0
							207207	207207	222200	224200	210200	.0	212200	.0	.0	.0
							0	0	0	0	0	0	0	0	2000	2000
23	1	142.5	1750.	50.	57	11	66.1	62.9	49.2	63.7	67.0	70.1	61.8	.0	.0	.0
							207207	207207	222200	224200	210200	.0	212200	.0	.0	.0
							0	0	0	0	0	0	0	0	1080	1080
23	101	.0	1750.	50.	0	11	60.1	56.9	42.8	57.7	61.0	66.1	55.8	.0	.0	.0
							207207	207207	222200	224200	210200	.0	212200	.0	.0	.0
							0	0	0	0	0	0	0	0	1080	1080

1987 0000 0000

TITLE- DATA SETS
JOB DESCRIPTIONS

MENLO PARK, SAN FRANCISCO BAY REGION STUDY AREA 11, 1981 POPULATION, 1976 COSTS,
STUDY AREA 11 LOW COST FUNCTIONS, NEW AUTOMOB. CASE 1, AUTO REINFORCE CASE 2.

BASE -0-0

FOR AN AVE POPULATION OF 3345, PERSONS, THE BASELINE NOISE IMPACT INDEX IS: .579245

 TITLE- DATA SET
 JOB DESCRIPTION

MENLO PARK, SAN FRANCISCO BAY REGION STUDY AREA 11, 1961 POPULATION, 1976 COSTS,
 STUDY AREA 11 LOW COST FUNCTIONS, NEW AUTOMOB. CASE 1, AUTO METRO/IT CASE 2.

 RANK -0-0

POPULATION WEIGHTED AVE INDICES FOR SOURCE RANKING										SOURCES (1-10) / (11-20)	
.067116	.015170	.005290	.043056	.034025	.185912	.122751	.000376	.001574	.000599		
.001463	.000000	.000000	.000000	.000000	.000000	.000000	.000000	.000000	.000000		

FRACTIONAL CONTRIBUTION TO NOISE IMPACT INDEX										SOURCES (1-10) / (11-20)	
.115060	.026203	.009132	.091595	.060753	.316811	.211916	.000650	.140036	.014045		
.003304	.000000	.000000	.000000	.000000	.000000	.000000	.000000	.000000	.000000		

MOST OFFENDING SOURCES: SOURCE NO.

- 1 MOTORCYCLES LOW SPEED LINE SRC. (6)
- 2 MOTORCYCLES LOCAL TRAFFIC SOURCE (7)
- 3 RAILROAD LOCOMOTIVES, LINE S. (9)
- 4 AUTOMOBILES LOW SPEED LINE SRC (1)
- 5 TRUCKS LOW SPEED LINE SRC. (4)
- 6 TRUCKS HIGH SPEED LINE SRC. (5)
- 7 AUTOMOBILES HIGH SPEED LINE SRC (2)
- 8 RAILROAD CARS, LINE SOURCE (10)
- 9 AUTOMOBILES LOCAL TRAFFIC SOURCE (3)
- 10 AIRCRAFT COMMERCIAL, FLIGHT (11)
- 11 BUSES LOW SPEED LINE SRC. (8)

FIRST COPY 1976

 TITLE: DATA SET1
 JOB DESCRIPTION:

MENLO PARK, SAN FRANCISCO BAY REGION STUDY AREA II, 1981 POPULATION, 1976 COSTS.
 STUDY AREA II LUM COST FUNCTIONS, NEW AUTOMON, CASE 3, AUTO METHOD II CASE 2.

 OPT -0-0

ADJUSTED INPUT EXPENDITURES:

0.	0.	0.	0.	0.	0.	0.	0.	0.	0.
0.	0.	0.	0.	0.	0.	0.	0.	0.	0.
									TOTAL = \$
									0.

TOTAL BUDGET = \$ 763440.00
 GRADIENT STEPSIZE = \$ 5000.00
 INITIAL MAX. EXPENDITURE RATIO = 2.00

STEP	EXPENDITURES (I-10) / (I1-20) /				GRADIENTS (I-10) / (I1-20)							
1	.000000	.000000	.000000	.000000	.000000	.000000	.000000	.000000	.000000	.000000	.000000	.000000
	.000000	.000000	.000000	.000000	.000000	.000000	.000000	.000000	.000000	.000000	.000000	.000000
	.163856-06	.414846-05	.348593-05	.113713-06	.156506-05	.836956-07	.251732-07	.377252-08	.832597-07	.152271-06	.000000	.000000
	.634941-06	.121299-05	.944519-06	.000000	.000000	.000000	.000000	.000000	.000000	.000000	.000000	.000000
INDEX	.579245	SUM = \$.00								
2	.000000	.000000	.000000	.000000	.000000	.000000	.000000	.496240+03	.000000	.000000	.000000	.000000
	.000000	.000000	.000000	.000000	.000000	.000000	.000000	.000000	.000000	.000000	.000000	.000000
	.267494-06	.726054-05	.888184-05	.237046-06	.289101-05	.140131-06	.410563-07	.000000	.136364-06	.445806-06	.000000	.000000
	.160934-07	.153068-05	.504032-06	.000000	.000000	.000000	.000000	.000000	.000000	.000000	.000000	.000000
INDEX	.393895	SUM = \$		496.24								
3	.000000	.598877+04	.000000	.000000	.000000	.000000	.000000	.496240+03	.000000	.000000	.000000	.000000
	.000000	.000000	.000000	.000000	.000000	.000000	.000000	.000000	.000000	.000000	.000000	.000000
	.281563-07	.136581-06	.186549-05	.310640-06	.145291-05	.173483-06	.488372-07	.000000	.633271-07	.217673-06	.000000	.000000
	.204661-07	.159009-05	.448023-06	.000000	.000000	.000000	.000000	.000000	.000000	.000000	.000000	.000000
INDEX	.357453	SUM = \$		885.01								
4	.000000	.598877+04	.000000	.000000	.999350+04	.000000	.000000	.496240+03	.000000	.000000	.000000	.000000
	.000000	.000000	.000000	.000000	.000000	.000000	.000000	.000000	.000000	.000000	.000000	.000000
	.111322-06	.172798-06	.237247-05	.403361-06	.187150-06	.204736-06	.530671-07	.000000	.746765-07	.257648-06	.000000	.000000
	.246595-07	.164261-05	.502409-06	.000000	.000000	.000000	.000000	.000000	.000000	.000000	.000000	.000000
INDEX	.336765	SUM = \$		16478.51								
5	.000000	.598877+04	.111300+04	.000000	.999350+04	.000000	.000000	.496240+03	.000000	.000000	.000000	.000000
	.000000	.000000	.000000	.000000	.000000	.000000	.000000	.000000	.000000	.000000	.000000	.000000
	.404000-07	.124568-06	.000000	.427174-06	.197374-06	.212202-06	.528874-07	.000000	.780031-07	.269409-06	.000000	.000000
	.254551-07	.165110-05	.502122-06	.000000	.000000	.000000	.000000	.000000	.000000	.000000	.000000	.000000
INDEX	.331059	SUM = \$		17591.51								

STEP	EXPENDITURES (1-10) / (11-20) / GRADIENTS (1-10) / (11-20)									
6	.000000	.598877+04	.111300+04	.000000	.999350+04	.000000	.000000	.496240+03	.000000	.000000
	.000000	.978415+04	.000000	.000000	.000000	.000000	.000000	.000000	.000000	.000000
	.787275-07	.122287-06	.000000	.406576-06	.186808-06	.212688-06	.527350-07	.000000	.789994-07	.238181-06
	.295527-07	.220028-05	.502122-06	.000000	.000000	.000000	.000000	.000000	.000000	.000000
INDEX#	.313280	SUM# 5	27375.66							
7	.000000	.598877+04	.111300+04	.000000	.999350+04	.000000	.000000	.496240+03	.000000	.000000
	.000000	.162231+05	.000000	.000000	.000000	.000000	.000000	.000000	.000000	.000000
	.741824-07	.122681-06	.000000	.406508-06	.187783-06	.212944-06	.528655-07	.000000	.691841-07	.222992-06
	.341088-07	.000000	.502122-06	.000000	.000000	.000000	.000000	.000000	.000000	.000000
INDEX#	.298176	SUM# 5	35814.61							
8	.000000	.598877+04	.111300+04	.000000	.999350+04	.000000	.000000	.496240+03	.000000	.000000
	.000000	.162231+05	.000000	.000000	.000000	.000000	.000000	.000000	.000000	.000000
	.787686-07	.122038-06	.000000	.410037-06	.189417-06	.213540-06	.528655-07	.000000	.691841-07	.222992-06
	.341088-07	.000000	.502122-06	.000000	.000000	.000000	.000000	.000000	.000000	.000000
INDEX#	.279297	SUM# 5	71814.61							
9	.000000	.598877+04	.111300+04	.640531+04	.999350+04	.000000	.000000	.496240+03	.000000	.000000
	.000000	.162231+05	.000000	.000000	.000000	.000000	.000000	.000000	.000000	.000000
	.813291-07	.126196-06	.000000	.427036-06	.182904-06	.216182-06	.553294-07	.000000	.710538-07	.224625-06
	.349099-07	.000000	.514373-06	.000000	.000000	.000000	.000000	.000000	.000000	.000000
INDEX#	.278659	SUM# 5	77814.92							
10	.000000	.598877+04	.111300+04	.130909+05	.999350+04	.000000	.000000	.496240+03	.000000	.000000
	.000000	.162231+05	.000000	.000000	.000000	.000000	.000000	.000000	.000000	.000000
	.846436-07	.131344-06	.000000	.447115-06	.174939-06	.214354-06	.581839-07	.000000	.732335-07	.236871-06
	.358259-07	.000000	.318620-06	.000000	.000000	.000000	.000000	.000000	.000000	.000000
INDEX#	.273707	SUM# 5	84505.46							
11	.000000	.598877+04	.111300+04	.201073+05	.999350+04	.000000	.000000	.496240+03	.000000	.000000
	.000000	.162231+05	.000000	.000000	.000000	.000000	.000000	.000000	.000000	.000000
	.882371-07	.136442-06	.000000	.458820-06	.165664-06	.222611-06	.615420-07	.000000	.748279-07	.242658-06
	.367866-07	.000000	.317807-06	.000000	.000000	.000000	.000000	.000000	.000000	.000000
INDEX#	.270629	SUM# 5	91521.90							
12	.000000	.598877+04	.111300+04	.274706+05	.999350+04	.000000	.000000	.496240+03	.000000	.000000
	.000000	.162231+05	.000000	.000000	.000000	.000000	.000000	.000000	.000000	.000000
	.905956-07	.140617-06	.000000	.452866-06	.152475-06	.226138-06	.655493-07	.000000	.777143-07	.252753-06
	.381328-07	.000000	.316424-06	.000000	.000000	.000000	.000000	.000000	.000000	.000000
INDEX#	.267159	SUM# 5	98885.17							
13	.000000	.598877+04	.111300+04	.346152+05	.999350+04	.000000	.000000	.496240+03	.000000	.000000
	.000000	.162231+05	.000000	.000000	.000000	.000000	.000000	.000000	.000000	.000000
	.945080-07	.146707-06	.000000	.254218-06	.144470-06	.228970-06	.690949-07	.000000	.802248-07	.256159-06
	.392196-07	.000000	.316223-06	.000000	.000000	.000000	.000000	.000000	.000000	.000000
INDEX#	.264350	SUM# 5	106029.70							
14	.000000	.598877+04	.111300+04	.346152+05	.999350+04	.000000	.000000	.496240+03	.000000	.000000
	.000000	.162231+05	.000000	.000000	.000000	.000000	.000000	.000000	.000000	.000000
	.957949-07	.146704-06	.000000	.253067-06	.143817-06	.224517-06	.690949-07	.000000	.802248-07	.256159-06
	.392196-07	.000000	.273308-06	.000000	.000000	.000000	.000000	.000000	.000000	.000000
INDEX#	.258802	SUM# 5	124229.70							

STEP

EXPENDITURES (1-10) / (11-20) / GRANTENTS (1-10) / (11-20)

15	.000000	.598877+04	.111300+04	.398152+05	.999350+04	.000000	.000000	.496240+03	.000000	.000000
	.000000	.162231+05	.223000+06	.000000	.000000	.000000	.000000	.000000	.000000	.000000
	.914405-07	.141951-06	.000000	.249217-06	.141617-06	.207890-06	.644962-07	.000000	.802248-07	.256159-06
	.192198-07	.000000	.237214-06	.000000	.000000	.000000	.000000	.000000	.000000	.000000
INDEX#	.212405	SUM# 3	291429.78							
16	.000000	.598877+04	.111300+04	.398152+05	.999350+04	.000000	.000000	.496240+03	.000000	.513927+04
	.000000	.162231+05	.223000+06	.000000	.000000	.000000	.000000	.000000	.000000	.000000
	.909730-07	.141231-06	.000000	.248132-06	.140989-06	.207890-06	.596898-07	.000000	.323871-07	.233970-06
	.191719-07	.000000	.237214-06	.000000	.000000	.000000	.000000	.000000	.000000	.000000
INDEX#	.211593	SUM# 3	296569.04							
17	.000000	.598877+04	.111300+04	.398453+05	.999350+04	.000000	.000000	.496240+03	.000000	.513927+04
	.000000	.162231+05	.223000+06	.000000	.000000	.000000	.000000	.000000	.000000	.000000
	.924771-07	.144272-06	.000000	.254221-06	.137311-06	.209100-06	.613029-07	.000000	.328994-07	.233893-06
	.190520-07	.000000	.236993-06	.000000	.000000	.000000	.000000	.000000	.000000	.000000
INDEX#	.210295	SUM# 3	301799.18							
18	.000000	.598877+04	.111300+04	.452088+05	.999350+04	.000000	.000000	.496240+03	.000000	.513927+04
	.000000	.162231+05	.223000+06	.000000	.000000	.000000	.000000	.000000	.000000	.000000
	.950461-07	.147570-06	.000000	.264853-06	.133383-06	.210367-06	.638598-07	.000000	.334560-07	.233432-06
	.193572-07	.000000	.236765-06	.000000	.000000	.000000	.000000	.000000	.000000	.000000
INDEX#	.200930	SUM# 3	307162.69							
19	.000000	.598877+04	.111300+04	.507175+05	.999350+04	.000000	.000000	.496240+03	.000000	.513927+04
	.000000	.162231+05	.223000+06	.000000	.000000	.000000	.000000	.000000	.000000	.000000
	.973581-07	.151173-06	.000000	.267218-06	.129172-06	.211684-06	.649799-07	.000000	.340595-07	.234106-06
	.200879-07	.000000	.236530-06	.000000	.000000	.000000	.000000	.000000	.000000	.000000
INDEX#	.207491	SUM# 3	312671.39							
20	.000000	.598877+04	.111300+04	.563661+05	.999350+04	.000000	.000000	.496240+03	.000000	.513927+04
	.000000	.162231+05	.223000+06	.007000	.000000	.000000	.000000	.000000	.000000	.000000
	.984844-07	.153589-06	.000000	.272184-06	.122893-06	.213056-06	.667942-07	.000000	.321312-07	.235443-06
	.204464-07	.000000	.236289-06	.000000	.000000	.000000	.000000	.000000	.000000	.000000
INDEX#	.205981	SUM# 3	318320.01							
21	.000000	.598877+04	.111300+04	.621257+05	.999350+04	.000000	.000000	.496240+03	.000000	.513927+04
	.000000	.162231+05	.223000+06	.000000	.000000	.000000	.000000	.000000	.000000	.000000
	.101632-06	.157834-06	.071000	.117396-06	.118112-06	.214472-06	.690816-07	.000000	.327644-07	.231024-06
	.206378-07	.000000	.236042-06	.000000	.000000	.000000	.000000	.000000	.000000	.000000
INDEX#	.204410	SUM# 3	324079.58							
22	.000000	.598877+04	.111300+04	.621257+05	.999350+04	.000000	.000000	.496240+03	.000000	.513927+04
	.000000	.162231+05	.340200+06	.000000	.000000	.000000	.000000	.000000	.000000	.000000
	.955400-07	.146341-06	.000000	.114355-06	.115063-06	.176207-06	.674598-07	.000000	.327630-07	.231023-06
	.206356-07	.000000	.116577-06	.000000	.000000	.000000	.000000	.000000	.000000	.000000
INDEX#	.164944	SUM# 3	441279.58							
23	.000000	.598877+04	.111300+04	.621257+05	.999350+04	.000000	.000000	.496240+03	.000000	.406585+04
	.000000	.162231+05	.340200+06	.000000	.000000	.000000	.000000	.000000	.000000	.000000
	.967031-07	.149505-06	.000000	.115835-06	.116552-06	.176207-06	.671384-07	.000000	.912402-12	.000000
	.912402-12	.000000	.116577-06	.000000	.000000	.000000	.000000	.000000	.000000	.000000
INDEX#	.180015	SUM# 3	495206.16							

STEP

EXPENDITURES (1-10) / (11-20) / REVENUES (1-10) / (11-20)

24	.000000	.598877+04	.111300+04	.621257+05	.999350+04	.500000+04	.000000	.496240+03	.000000	.906585+04
	.000000	.162231+05	.390200+06	.000000	.000000	.000000	.000000	.000000	.000000	.000000
	.971959-07	.150267-06	.000000	.116298-06	.117017-06	.180056-06	.681873-07	.000000	.456201-12	.000000
	.456201-12	.000000	.115080-06	.000000	.000000	.000000	.000000	.000000	.000000	.000000
INDEX#	.163132	SUM# 3	500206.16							
25	.000000	.598877+04	.111300+04	.621257+05	.999350+04	.500000+05	.000000	.496240+03	.000000	.906585+04
	.000000	.162231+05	.390200+06	.000000	.000000	.000000	.000000	.000000	.000000	.000000
	.977096-07	.151865-06	.000000	.117281-06	.117505-06	.184079-06	.681601-07	.000000	.136860-11	.000000
	.136860-11	.000000	.113545-06	.000000	.000000	.000000	.000000	.000000	.000000	.000000
INDEX#	.162251	SUM# 3	500206.16							
26	.000000	.598877+04	.111300+04	.621257+05	.999350+04	.500000+05	.000000	.496240+03	.000000	.906585+04
	.000000	.162231+05	.390200+06	.000000	.000000	.000000	.000000	.000000	.000000	.000000
	.982461-07	.151896-06	.000000	.117288-06	.118014-06	.186247-06	.681724-07	.000000	.136860-11	.000000
	.136860-11	.000000	.111970-06	.000000	.000000	.000000	.000000	.000000	.000000	.000000
INDEX#	.161311	SUM# 3	510206.16							
27	.000000	.598877+04	.111300+04	.621257+05	.999350+04	.500000+05	.000000	.496240+03	.000000	.906585+04
	.000000	.162231+05	.390200+06	.000000	.000000	.000000	.000000	.000000	.000000	.000000
	.988054-07	.152765-06	.000000	.117818-06	.118546-06	.192692-06	.681852-07	.000000	.912402-12	.000000
	.912402-12	.000000	.110354-06	.000000	.000000	.000000	.000000	.000000	.000000	.000000
INDEX#	.160369	SUM# 3	515206.16							
28	.000000	.598877+04	.111300+04	.621257+05	.999350+04	.500000+05	.000000	.496240+03	.000000	.906585+04
	.000000	.162231+05	.390200+06	.000000	.000000	.000000	.000000	.000000	.000000	.000000
	.993435-07	.151676-06	.000000	.118171-06	.119104-06	.197311-06	.681994-07	.000000	.182460-11	.000000
	.182460-11	.000000	.108443-06	.000000	.000000	.000000	.000000	.000000	.000000	.000000
INDEX#	.159406	SUM# 3	520206.16							
29	.000000	.598877+04	.111300+04	.621257+05	.999350+04	.500000+05	.000000	.496240+03	.000000	.906585+04
	.000000	.162231+05	.390200+06	.000000	.000000	.000000	.000000	.000000	.000000	.000000
	.100000-06	.154630-06	.000000	.118451-06	.119688-06	.202157-06	.682134-07	.000000	.912402-12	.000000
	.912402-12	.000000	.106487-06	.000000	.000000	.000000	.000000	.000000	.000000	.000000
INDEX#	.150419	SUM# 3	525206.16							
30	.000000	.598877+04	.111300+04	.621257+05	.999350+04	.500000+05	.000000	.496240+03	.000000	.906585+04
	.000000	.162231+05	.390200+06	.000000	.000000	.000000	.000000	.000000	.000000	.000000
	.100653-06	.155633-06	.000000	.119583-06	.120301-06	.174946-06	.682294-07	.000000	.136860-11	.000000
	.136860-11	.000000	.105231-06	.000000	.000000	.000000	.000000	.000000	.000000	.000000
INDEX#	.157409	SUM# 3	530206.16							
31	.000000	.598877+04	.111300+04	.621257+05	.999350+04	.500000+05	.000000	.496240+03	.000000	.906585+04
	.000000	.162231+05	.390200+06	.000000	.000000	.000000	.000000	.000000	.000000	.000000
	.904578-07	.140597-06	.000000	.112544-06	.113291-06	.144470-06	.682445-07	.000000	.000000	.000000
	.000000	.000000	.103424-06	.000000	.000000	.000000	.000000	.000000	.000000	.000000
INDEX#	.156538	SUM# 3	535206.16							
32	.000000	.598877+04	.111300+04	.621257+05	.999350+04	.450000+05	.000000	.496240+03	.000000	.906585+04
	.000000	.162231+05	.390200+06	.000000	.000000	.000000	.000000	.000000	.000000	.000000
	.41150-07	.141306-06	.000000	.113081-06	.113760-06	.146074-06	.682616-07	.000000	.456201-12	.000000
	.456201-12	.000000	.101562-06	.000000	.000000	.000000	.000000	.000000	.000000	.000000
INDEX#	.155010	SUM# 3	540206.16							

STEP	EXPENDITURES (I-10) / (II-20) / GRANTIES (I-10) / (II-20)									
51	.100000+05	.124377+05	.111300+04	.671257+05	.299935+05	.920899+05	.000000	.496240+03	.000000	.906585+04
	.000000	.162231+05	.340200+06	.000000	.000000	.000000	.000000	.000000	.000000	.000000
	.862305-07	.000000	.000000	.532598-07	.527136-07	.000000	.648407-07	.000000	.456201-12	.000000
	.456201-12	.000000	.000000	.000000	.000000	.000000	.000000	.000000	.000000	.000000
INDEX	.140476	SUM	\$	628745.04						
52	.100000+05	.124377+05	.111300+04	.671257+05	.299935+05	.920899+05	.000000	.496240+03	.000000	.906585+04
	.000000	.162231+05	.471400+06	.000000	.000000	.000000	.000000	.000000	.000000	.000000
	.876602-07	.000000	.000000	.524719-07	.514149-07	.000000	.648407-07	.000000	.644302-12	.000000
	.684302-12	.000000	.000000	.000000	.000000	.000000	.000000	.000000	.000000	.000000
INDEX	.133280	SUM	\$	709945.05						
53	.150000+05	.124377+05	.111300+04	.671257+05	.299935+05	.920899+05	.000000	.496240+03	.000000	.906585+04
	.000000	.162231+05	.495025+06	.000000	.000000	.000000	.000000	.000000	.000000	.000000
	.324583-07	.000000	.000000	.532598-07	.527124-07	.000000	.658355-07	.000000	.456201-12	.000000
	.456201-12	.000000	.000000	.000000	.000000	.000000	.000000	.000000	.000000	.000000
INDEX	.132619	SUM	\$	714945.04						
54	.150000+05	.124377+05	.111300+04	.671257+05	.299935+05	.920899+05	.000000	.496240+03	.000000	.906585+04
	.000000	.162231+05	.495025+06	.000000	.000000	.000000	.000000	.000000	.000000	.000000
	.374505-07	.000000	.000000	.532598-07	.527129-07	.000000	.658360-07	.000000	.412402-12	.000000
	.912402-12	.000000	.000000	.000000	.000000	.000000	.000000	.000000	.000000	.000000
INDEX	.130968	SUM	\$	738570.04						
55	.150000+05	.124377+05	.111300+04	.671257+05	.299935+05	.920899+05	.500000+04	.496240+03	.000000	.906585+04
	.000000	.162231+05	.495025+06	.000000	.000000	.000000	.000000	.000000	.000000	.000000
	.326425-07	.000000	.000000	.537038-07	.531525-07	.000000	.174109-07	.000000	.228101-12	.000000
	.228101-12	.000000	.000000	.000000	.000000	.000000	.000000	.000000	.000000	.000000
INDEX	.130639	SUM	\$	743570.04						
56	.150000+05	.124377+05	.111300+04	.671257+05	.299935+05	.920899+05	.500000+04	.496240+03	.000000	.906585+04
	.000000	.162231+05	.495025+06	.000000	.000000	.000000	.000000	.000000	.000000	.000000
	.328912-07	.000000	.000000	.540649-07	.527133-07	.000000	.175109-07	.000000	.228101-12	.000000
	.228101-12	.000000	.000000	.000000	.000000	.000000	.000000	.000000	.000000	.000000
INDEX	.130370	SUM	\$	748570.05						
57	.150000+05	.124377+05	.111300+04	.671257+05	.299935+05	.920899+05	.500000+04	.496240+03	.000000	.906585+04
	.000000	.162231+05	.495025+06	.000000	.000000	.000000	.000000	.000000	.000000	.000000
	.330974-07	.000000	.000000	.544310-07	.522644-07	.000000	.176341-07	.000000	.000000	.000000
	.000000	.000000	.000000	.000000	.000000	.000000	.000000	.000000	.000000	.000000
INDEX	.130100	SUM	\$	753570.04						
58	.150000+05	.124377+05	.111300+04	.671257+05	.299935+05	.920899+05	.500000+04	.496240+03	.000000	.906585+04
	.000000	.162231+05	.495025+06	.000000	.000000	.000000	.000000	.000000	.000000	.000000
	.332470-07	.000000	.000000	.548034-07	.518140-07	.000000	.177786-07	.000000	.228101-12	.000000
	.228101-12	.000000	.000000	.000000	.000000	.000000	.000000	.000000	.000000	.000000
INDEX	.129028	SUM	\$	758570.05						
59	.150000+05	.124377+05	.111300+04	.671257+05	.299935+05	.920899+05	.500000+04	.496240+03	.000000	.906585+04
	.000000	.162231+05	.495025+06	.000000	.000000	.000000	.000000	.000000	.000000	.000000
	.334991-07	.000000	.000000	.551709-07	.513676-07	.000000	.179009-07	.000000	.456201-12	.000000
	.456201-12	.000000	.000000	.000000	.000000	.000000	.000000	.000000	.000000	.000000
INDEX	.129561	SUM	\$	763490.00						

STEP

EXPENSES (LINES (1-10) / (11-20) / CHARGES (1-10) / (11-20))

42	.000000	.548677+04	.111300+04	.621257+05	.299450+04	.920499+05	.000000	.496240+03	.000000	.906585+04
	.000000	.162231+05	.390200+06	.000000	.000000	.000000	.000000	.000000	.000000	.000000
	.421840-07	.142512-06	.000000	.113074-06	.000000	.000000	.000000	.000000	.000000	.000000
	.114050-11	.000000	.892144-07	.000000	.711725-06	.000000	.644413-07	.000000	.114050-11	.000000
INDEX#	.147654	SUM# 3	597246.11	.000000	.000000	.000000	.000000	.000000	.000000	.000000
43	.000000	.104888+05	.111300+04	.621257+05	.299450+04	.920499+05	.000000	.496240+03	.000000	.906585+04
	.000000	.162231+05	.390200+06	.000000	.000000	.000000	.000000	.000000	.000000	.000000
	.863824-07	.134140-06	.000000	.111247-06	.111475-06	.000000	.645032-07	.000000	.000000	.000000
	.159670-11	.000000	.893781-07	.000000	.000000	.000000	.000000	.000000	.159670-11	.000000
INDEX#	.147626	SUM# 3	592296.10	.000000	.000000	.000000	.000000	.000000	.000000	.000000
44	.000000	.124377+05	.111300+04	.621257+05	.299450+04	.920499+05	.000000	.496240+03	.000000	.906585+04
	.000000	.162231+05	.390200+06	.000000	.000000	.000000	.000000	.000000	.000000	.000000
	.855110-07	.000000	.000000	.111754-06	.112445-06	.000000	.697919-07	.000000	.000000	.000000
	.864302-12	.000000	.894212-07	.000000	.000000	.000000	.000000	.000000	.864302-12	.000000
INDEX#	.147631	SUM# 3	593745.05	.000000	.000000	.000000	.000000	.000000	.000000	.000000
45	.000000	.124377+05	.111300+04	.621257+05	.299450+04	.920499+05	.000000	.496240+03	.000000	.906585+04
	.000000	.162231+05	.390200+06	.000000	.000000	.000000	.000000	.000000	.000000	.000000
	.877462-07	.000000	.000000	.114464-06	.111914-06	.000000	.711216-07	.000000	.000000	.000000
	.912402-12	.000000	.891864-07	.000000	.000000	.000000	.000000	.000000	.912402-12	.000000
INDEX#	.146348	SUM# 3	590745.04	.000000	.000000	.000000	.000000	.000000	.000000	.000000
46	.000000	.124377+05	.111300+04	.621257+05	.299450+04	.920499+05	.000000	.496240+03	.000000	.906585+04
	.000000	.162231+05	.390200+06	.000000	.000000	.000000	.000000	.000000	.000000	.000000
	.864751-07	.000000	.000000	.441326-07	.110142-06	.000000	.692460-07	.000000	.000000	.000000
	.456201-12	.000000	.890764-07	.000000	.000000	.000000	.000000	.000000	.456201-12	.000000
INDEX#	.145823	SUM# 3	603745.04	.000000	.000000	.000000	.000000	.000000	.000000	.000000
47	.000000	.124377+05	.111300+04	.621257+05	.299450+04	.920499+05	.000000	.496240+03	.000000	.906585+04
	.000000	.162231+05	.390200+06	.000000	.000000	.000000	.000000	.000000	.000000	.000000
	.913675-07	.000000	.000000	.445814-07	.109242-06	.000000	.652313-07	.000000	.000000	.000000
	.000000	.000000	.888135-07	.000000	.000000	.000000	.000000	.000000	.000000	.000000
INDEX#	.144537	SUM# 3	600745.05	.000000	.000000	.000000	.000000	.000000	.000000	.000000
48	.000000	.124377+05	.111300+04	.621257+05	.299450+04	.920499+05	.000000	.496240+03	.000000	.906585+04
	.000000	.162231+05	.390200+06	.000000	.000000	.000000	.000000	.000000	.000000	.000000
	.922831-07	.000000	.000000	.502558-07	.105416-06	.000000	.611353-07	.000000	.456201-12	.000000
	.456201-12	.000000	.885056-07	.000000	.000000	.000000	.000000	.000000	.000000	.000000
INDEX#	.143211	SUM# 3	613745.04	.000000	.000000	.000000	.000000	.000000	.000000	.000000
49	.000000	.124377+05	.111300+04	.621257+05	.299450+04	.920499+05	.000000	.496240+03	.000000	.906585+04
	.000000	.162231+05	.390200+06	.000000	.000000	.000000	.000000	.000000	.000000	.000000
	.947941-07	.000000	.000000	.516178-07	.510877-07	.000000	.624104-07	.000000	.114050-11	.000000
	.114050-11	.000000	.883124-07	.000000	.000000	.000000	.000000	.000000	.000000	.000000
INDEX#	.141073	SUM# 3	618745.04	.000000	.000000	.000000	.000000	.000000	.000000	.000000
50	.500000+04	.124377+05	.111300+04	.621257+05	.299450+04	.920499+05	.000000	.496240+03	.000000	.906585+04
	.000000	.162231+05	.390200+06	.000000	.000000	.000000	.000000	.000000	.000000	.000000
	.948816-07	.000000	.000000	.524208-07	.510877-07	.000000	.618446-07	.000000	.864302-12	.000000
	.864302-12	.000000	.884753-07	.000000	.000000	.000000	.000000	.000000	.000000	.000000
INDEX#	.141100	SUM# 3	621745.04	.000000	.000000	.000000	.000000	.000000	.000000	.000000

STEP	EXPENDITURES (1-10) / (11-20) / GRADIENTS (1-10) / (11-20)									
33	.000000	.598877+04	.111300+04	.621257+05	.999350+04	.500000+05	.000000	.496240+03	.000000	.906585+04
	.000000	.162231+05	.390200+06	.000000	.000000	.000000	.000000	.000000	.000000	.000000
	.916403-07	.142053-06	.000000	.113593-06	.114297-06	.153002-06	.687705-07	.000000	.456201-12	.000000
	.456201-12	.000000	.998406-07	.000000	.000000	.000000	.000000	.000000	.000000	.000000
INDEX#	.155065	SUM# 3	549206.16							
34	.000000	.598877+04	.111300+04	.621257+05	.999350+04	.500000+05	.000000	.496240+03	.000000	.906585+04
	.000000	.162231+05	.390200+06	.000000	.000000	.000000	.000000	.000000	.000000	.000000
	.924054-07	.142054-06	.000000	.114137-06	.114843-06	.153425-06	.683002-07	.000000	.912402-12	.000000
	.912402-12	.000000	.976574-07	.000000	.000000	.000000	.000000	.000000	.000000	.000000
INDEX#	.154300	SUM# 3	550206.15							
35	.000000	.598877+04	.111300+04	.621257+05	.999350+04	.600000+05	.000000	.496240+03	.000000	.906585+04
	.000000	.162231+05	.390200+06	.000000	.000000	.000000	.000000	.000000	.000000	.000000
	.929432-07	.143679-06	.000000	.114710-06	.115419-06	.162113-06	.683198-07	.000000	.456201-12	.000000
	.456201-12	.000000	.956076-07	.000000	.000000	.000000	.000000	.000000	.000000	.000000
INDEX#	.153513	SUM# 3	555206.15							
36	.000000	.598877+04	.111300+04	.621257+05	.999350+04	.650000+05	.000000	.496240+03	.000000	.906585+04
	.000000	.162231+05	.390200+06	.000000	.000000	.000000	.000000	.000000	.000000	.000000
	.998757-07	.138476-06	.000000	.110621-06	.111300-06	.143132-06	.683421-07	.000000	.456201-12	.000000
	.456201-12	.000000	.934868-07	.000000	.000000	.000000	.000000	.000000	.000000	.000000
INDEX#	.152703	SUM# 3	560206.15							
37	.000000	.598877+04	.111300+04	.621257+05	.999350+04	.700000+05	.000000	.496240+03	.000000	.906585+04
	.000000	.162231+05	.390200+06	.000000	.000000	.000000	.000000	.000000	.000000	.000000
	.895623-07	.138414-06	.000000	.110320-06	.111003-06	.146995-06	.683654-07	.000000	.456201-12	.000000
	.456201-12	.000000	.927653-07	.000000	.000000	.000000	.000000	.000000	.000000	.000000
INDEX#	.151967	SUM# 3	565206.15							
38	.000000	.598877+04	.111300+04	.621257+05	.999350+04	.750000+05	.000000	.496240+03	.000000	.906585+04
	.000000	.162231+05	.390200+06	.000000	.000000	.000000	.000000	.000000	.000000	.000000
	.900808-07	.139252-06	.000000	.110662-06	.111548-06	.151484-06	.683903-07	.000000	.226101-12	.000000
	.226101-12	.000000	.920504-07	.000000	.000000	.000000	.000000	.000000	.000000	.000000
INDEX#	.151252	SUM# 3	570206.15							
39	.000000	.598877+04	.111300+04	.621257+05	.999350+04	.800000+05	.000000	.496240+03	.000000	.906585+04
	.000000	.162231+05	.390200+06	.000000	.000000	.000000	.000000	.000000	.000000	.000000
	.406515-07	.140126-06	.000000	.111442-06	.112131-06	.157327-06	.684172-07	.000000	.856201-12	.000000
	.456201-12	.000000	.912883-07	.000000	.000000	.000000	.000000	.000000	.000000	.000000
INDEX#	.150492	SUM# 3	575206.15							
40	.000000	.598877+04	.111300+04	.621257+05	.999350+04	.850000+05	.000000	.496240+03	.000000	.906585+04
	.000000	.162231+05	.390200+06	.000000	.000000	.000000	.000000	.000000	.000000	.000000
	.912546-07	.141062-06	.000000	.112061-06	.112756-06	.163062-06	.684459-07	.000000	.456201-12	.000000
	.456201-12	.000000	.904740-07	.000000	.000000	.000000	.000000	.000000	.000000	.000000
INDEX#	.149706	SUM# 3	580206.15							
41	.000000	.598877+04	.111300+04	.621257+05	.999350+04	.900000+05	.000000	.496240+03	.000000	.906585+04
	.000000	.162231+05	.390200+06	.000000	.000000	.000000	.000000	.000000	.000000	.000000
	.919031-07	.142069-06	.000000	.112731-06	.113429-06	.169236-06	.684776-07	.000000	.114050-11	.000000
	.114050-11	.000000	.896014-07	.000000	.000000	.000000	.000000	.000000	.000000	.000000
INDEX#	.140899	SUM# 3	585206.15							

 PATH-RECEIVED HEARDOWN BY CELL

ZONE	CELL	IND USE	CELL POP.	TOTAL ADV. AFF. NO P-R MODS	REMAINING ADV. AFF. W/ P-R MODS	PER-CENT ADV. AFF. NO P-R MODS	PER-CENT ADV. AFF. W/ P-R MODS	P-R MOD TYPE	P-R MOD EXPENDITURE
1	1	11	142.5	.0	.0	.000	.000	0	.00
2	1	4	7.5	.7	.7	9.287	9.287	0	.00
3	1	5	174.4	.0	.0	.000	.000	0	.00
4	1	1	40.9	.0	.0	.000	.000	0	.00
4	2	1	53.1	.3	.3	.554	.554	0	.00
5	1	1	102.4	35.0	35.0	34.752	34.752	0	.00
5	2	1	81.4	.0	.0	.000	.000	0	.00
6	1	1	55.9	24.2	24.2	43.359	43.359	0	.00
6	2	1	18.4	.0	.0	.000	.000	0	.00
7	1	1	29.6	11.5	11.5	38.779	38.779	0	.00
7	2	1	50.0	.0	.0	.000	.000	0	.00
8	1	1	103.9	69.4	69.4	42.335	42.335	0	.00
9	1	1	22.1	.2	.2	.778	.778	0	.00
9	2	1	102.9	62.6	62.6	60.840	60.840	0	.00
9	3	1	33.7	7.5	7.5	22.215	22.215	0	.00
10	1	1	22.1	12.9	7.4	56.481	33.520	1	23625.00
10	2	1	3.0	.0	.0	.000	.000	0	.00
11	1	1	12.2	2.4	2.4	19.452	19.452	0	.00
11	2	1	9.9	.0	.0	.000	.000	0	.00
12	1	11	142.5	.0	.0	.000	.000	0	.00
13	1	1	87.9	7.9	7.9	9.045	9.045	0	.00
13	2	1	29.6	.0	.0	.000	.000	0	.00
14	1	12	314.0	.0	.0	.000	.000	0	.00
15	1	1	32.4	.7	.7	2.109	2.109	0	.00
15	2	1	33.4	.0	.0	.000	.000	0	.00
15	3	1	271.5	.0	.0	.000	.000	0	.00
16	1	4	144.7	69.0	69.0	40.145	40.145	0	.00
17	1	1	64.7	20.1	20.1	41.382	41.382	0	.00
17	2	1	71.9	23.7	23.7	32.950	32.950	0	.00
18	1	1	41.9	17.1	17.1	40.894	40.894	0	.00
18	2	1	46.7	.0	.0	.000	.000	0	.00
19	1	11	142.5	.0	.0	.000	.000	0	.00
20	1	4	21.5	15.9	15.9	74.000	74.000	0	.00
21	1	1	98.1	65.0	20.1	66.614	20.596	4	167200.00
21	2	1	144.7	43.1	.0	29.770	.000	4	.00
21	3	1	72.9	9.0	.0	13.211	.000	4	.00
22	1	1	150.4	130.9	20.2	66.261	12.916	5	246000.00
22	2	1	155.0	50.6	.0	32.623	.000	5	.00
23	1	11	142.5	69.9	.0	49.083	.000	5	55000.00

Note: Cells 21-2, 21-3, 23-1 are secondary cells receiving "free" benefit of barrier at primary cell location.

PATH-RECEIVER MOOD COST HHEARDUANE

SP-1	SP-2	SP-3	H-1	H-2	RELOCATE	SP-1/B-1	SP-2/B-1	SP-3/B-1	SP-1/B-2	SP-2/B-2	SP-3/B-2
23625.	0.	0.	167200.	309200.	0.	0.	0.	0.	0.	0.	0.

PATH-RECEIVER EXPENDITURE * \$ 495025.00

COST OF NEXT P-R MEASURE * \$ 60355.00

FINAL EXPENDITURES:

15000.	12438.	1115.	86496.	29995.	92090.	5000.	496.	0.	9066.
0.	16223.	495025.	0.	0.	0.	0.	0.	0.	0.

TOTAL = \$ 763880.

FINAL COUNTERMEASURE VARIABLES:

.165605-00	.620000+01	.568000-00	.370285-00	.500192-00	.100000+01	.333732+01	.170000+02	-.000000	.100000+01
-.000000	.100000+01	.495025+00	.000000	.000000	.000000	.000000	.000000	.000000	.000000

IMPACT GRADIENT VECTOR (REDUCTION IN NII/S):

.334991-07	.000000	.000000	.551709-07	.313676-07	.000000	.179009-07	.000000	-.456201-12	.000000
-.456201-12	.000000	.000000	.000000	.000000	.000000	.000000	.000000	.000000	.000000

GRADIENT MAGNITUDE = .644102-07

COUNTERMEASURE RANKINGS:	4	5	1	7	13	12	3	10	2	8	6	11	9
SPENDING LIMIT REACHED:	0	0	0	0	0	1	1	1	1	1	1	0	0

NOISE IMPACT INDEX = .129561-00
 RED. FROM BASELINE = .449684-00
 COST/BENEFIT RATIO = .507579+03 \$/PERSON

TITLE- DATA SET
JOB DESCRIPTION

MENLO PARK, SAN FRANCISCO BAY REGION STUDY AREA II, 1981 POPULATION, 1976 COSTS.
STUDY AREA II LUM COST FUNCTIONS, NEW AUTUMN, CASE 1, AUTO METROPOLITAN CASE 2.

END -0-0

APPENDIX A
NOISE OPTIMIZATION PROGRAM

A.1 Introduction

This appendix provides a brief technical description of the Community Noise Countermeasure Cost-Effectiveness Computer Program (called Noizop). * This program is briefly described in the summary statement below.

The acoustic environment of a community is modeled by the definition of small acoustically homogeneous divisions called cells. The source noise levels from up to 20 transportation (moving or stationary) noise sources can be specified at each of up to 200 cell locations. The user may define up to 20 countermeasures (noise reduction strategies) selected from an available list of eight alternate theoretical approaches to abate the noise sources. Additional input consists of the effectiveness and implementation costs for each of the defined countermeasures. The program calculates a single number evaluation of the noise climate in the community called the Noise Impact Index (NII) which is equivalent to the fraction of people in the community who would consider noise to be a significant detriment to their environment. The NII is the objective function which Noizop will seek to minimize using nonlinear optimization techniques. Constraining factors include feasible implementation (expenditure) limits on each countermeasure as well as a total budget for all countermeasures together. The end result is an optimum solution set for expenditure allocation among the countermeasures.

For the preparation of this strategy manual, an earlier version of Noizop was modified and enhanced to provide a tool suitable for use by local governments. The earlier program was referred to as version 2.1. The current version, described herein, is numbered 2.2.

Section A.2 describes each of the modifications to Noizop and serves as an update to the User's and Programmer's Guides.

*Glenn, P.K., "Community Noise Countermeasures Cost Effectiveness Optimization Computer Program (Noizop)," Wyle Research Report WCR 76-15, Volumes I-III, for the Motor Vehicle Manufacturers Association, Inc., June 1977.

Section A.3 illustrates six hypothetical applications of Noizop on an actual Northern California community. Although these results are test cases and are not intended for implementation, they serve as a partial illustration of the range of potential uses of Noizop to local city governments and planning agencies.

Section A.4 is an application of Noizop to Allentown, Pennsylvania. This application, following directly from the procedures described in earlier sections of this manual, was performed to provide city officials of Allentown with an optimal noise abatement planning strategy.

A.2 Updates to the User's Guide and Programmer's Guide

A.2.1 User's Guide Updates

To furnish a computer utility suitable for local governments and planning agencies, several enhancements and updates were made to an already existing version of Noizop. The following discussion describes all additions and modifications that have been made to the program. Table A-1 summarizes these changes. Parenthetical references are made to section numbers of the User's Guide where the related material is discussed. In the following discussion it is assumed that the reader is familiar with the Noizop User's Guide.

1. Criterion Level Specification

Lower criterion levels (zero percent adverse response) which previously needed to be input with each cell have been given default values. These default values are listed in Table A-2. The user may now leave a blank data field for the lower criterion level specification on the appropriate input data card (Section 2.1).

In addition, the default upper criterion levels (100 percent adverse response) have been revised to agree with EPA-recommended levels (Section 2.7). These are also listed in Table A-2.

Table A-1
Additions and Modifications to Noizop

Addition or Modification	Related Section(s) in User's Guide
1. Criterion Level Specification	2.1, 2.7
2. Countermeasure Type Numbers	2.2
3. Countermeasure Indicators	2.2
4. Default Transfer Function	2.7
5. Input of User Cost Portions	New Addition
6. Attitudinal Source Level Adjustments	New Addition
7. Gradient Stepsize	2.11.1
8. Optimization Process	2.11
9. Output of Bar Graph Summarizing Results	New Addition

Table A-2
 Default Criterion Levels
 (Tables 2-2 and 2-7)

Land Use Code	Suggested Usage	Default Lower Criterion Levels (0% adverse response, dB)		Default Upper Criterion Levels (100% adverse response, dB)	
		Day	Night	Day	Night
1	Single and Two-family Residential	54	46	74	66
2	Open for Additional Residential Use	54	46	74	66
3	Single, Two, and Multifamily Residential	54	46	74	66
4	Multifamily Residential	59	46	79	66
5	Business and Commercial	59	59	79	79
6	Wholesale and Warehousing	59	59	79	79
7	Central Business District	59	59	79	79
8	Industrial	70	70	90	90
9	Public and Semi-public Areas	None	None	None	None
10	Parks	55	—	75	—
11	Schools	55	—	75	—
12	Hospitals and Nursing Homes	50	50	70	70
13	Open	None	None	None	None
14	Open	None	None	None	None
15	Open	None	None	None	None

BEST COPY AVAILABLE

2. Countermeasure Type Numbers

The countermeasure type numbers have been redefined in order to simplify the notation used in the previous version (Section 2.2). Table A-3 lists the old and new countermeasure type numbers. The user should use the new type numbers on the countermeasure definition data cards.

Table A-3
Countermeasure Type Numbers

Type Number		Countermeasure Definition
Old	New	
1	1	A reduction in the frequency of operation of the noise source. The fractional reduction is the same during the day and at night.
3	2	A reduction in the frequency of nighttime operation of the noise source.
5	3	A shifting of the nighttime activity into the daytime period, or vice versa.
10	4	Application of a device that produces a fixed L_{eq} reduction to a portion of the source population.
12	5	An overall L_{eq} reduction.
15	6	Like 10, except that no further modifications are allowed to the treated portion of the source population.
18	7	Stationary source countermeasures.
20	8	Path or receiver modifications.

3. Countermeasure Indicators

Countermeasure types with new numbers 4 and 6 (see Table A-3) require countermeasure manipulation indicators to be defined (Section 2.2). The original

version of Noizop permitted decibel reduction values which comprise the indicator to be entered to an accuracy no better than 0.5 dB. For local government application the definition of the indicator has been altered to allow entry of decibel reduction values accurate to 0.1 dB. The new definition is:

$$I = (dB1 \times 10 + 200) \times 1000 + (dB2 \times 10 + 200)$$

where

dB1 = maximum decibel reduction at the cell location for this countermeasure or the primary noise source.

dB2 = maximum decibel reduction at the cell location for this countermeasure on the secondary noise source.

Note that the maximum range of the decibel reductions have been reduced from ± 100 dB to ± 20 dB.

4. Default Transfer Function

The default transfer function is now linear allowing a value greater than 100 percent adverse response (Section 2.7). The previous default transfer function was also linear but did not allow a value greater than 100 percent adverse response. This change was accomplished by giving the bulge parameter a default value of 1.

5. Input of User Cost Portions

A feature has been added which allows the user (in this case the local government) to specify the fraction of the costs for a countermeasure which he bears. Total costs for a countermeasure are still comprehensive societal costs as these costs still form the basis for the optimization. An additional codeword is now allowed - USER - which is used to enter the cost fractions. The first card following the USER codeword is a title card which may contain any pertinent information. The first 72 columns of the card may be used. The second (also the last) succeeding data card contains the countermeasure cost fractions (i.e., between 0. and 1.). The input format for this card is 20F4.0. The first field (columns 1 through 4) contains the fraction for countermeasure number 1, the tenth field (columns 37-40) contains the fraction for

countermeasure number 10, etc. The default values for the user cost fractions are all unity, 1. Default values for user cost portions are initiated by not implementing the USER codeword.

The local government budget for noise abatement measures may be considerably less than the total societal budget. The user may determine the optimum disposition of the countermeasures at the user budget level by finding the optimization procedure step number in the computer output which expended a user cost value equal to the local government budget. The total user cost is printed along with the total societal cost for every step. Again, note that the countermeasures are optimized for the total cost rather than the user cost.

6. Attitudinal Source Level Adjustments

The capability to modify source noise levels for attitudinal biases has been added. The formula for making the adjustment is shown below.

$$L_{aq} \text{ (new)} = L_{aq} \text{ (old)} - \text{Corr}$$

The parameter in the above expression, Corr, is input to the program through the use of a new codeword, CORR. The CORR codeword allows an option parameter, a nonzero number in column 6 of the codeword card, which will cause a formatted listing of the main cell data to be printed showing the modified source levels. This printout option is the same option included with the DTA and FAC codewords (Sections 2.1 and 2.8, respectively).

The first data card following the codeword card is a title card of which the first 72 columns may be used. The succeeding data cards have the format as follows:

<u>Field Number</u>	<u>Format</u>	<u>Data Item</u>
1	I5	Noise Source Number
2	F5.0	Corr Value for this Source, dB

One card is required for each source receiving an attitudinal adjustment. A blank data card must follow the last adjustment data card to return control to the main program.

Note that the adjustment value, Corr, is subtracted from the source levels. Consequently, negative adjustments will increase the apparent levels while positive adjustments will decrease them.

Noizop will print the following diagnostic message if an invalid noise source number (greater than 20) is placed in field number 1 above.

INVALID SOURCE NUMBER IN ATTITUDINAL ADJUSTMENTS

This message will be printed identically in both the main and auxiliary print files.

7. Gradient Stepsize

The gradient stepsize (Section 2.11.1) is given a default value, initiated by a blank field on the appropriate data card, of the total specified budget divided by 100.; not \$10,000 as mentioned in the User's Guide.

8. Enhancement of Optimization Process

This discussion complements and updates Section 2.11 of the Noizop User's Guide.

Because of a potential manyfold increase in the volume of output that is produced, the "1" option parameter now controls the printing of the results after each of the steps in the optimization procedure. The options are described in Table A-4.

The input data card containing the optimization control parameters now contains five parameters. The format is 4F10.0, 110:

1. The total budget
2. The gradient stepsize
3. The initial maximum expenditure ratio
4. The expenditure retraction factor
5. The number of refinement stages

Table A-4

First Option Parameter for OPT Codeword

Parameter Value	Effect
-1	Suppresses the printing of each of the steps in the optimization procedure from the main print as well as the auxiliary output file. Only the input expenditures and optimization control parameters are printed. No breakdown of path-receiver measures by cell location is given.
0	This is the default value. All steps in the optimization procedure are printed in both the main and auxiliary output files. A breakdown of path-receiver measures by cell location is provided.
1	Suppress the printing of each of the steps in the optimization process in the main print file. The abbreviated form is still provided in the auxiliary output file. No breakdown of path-receiver measures by cell location is given.

Parameters 1-3 are described in the Noizop User's Guide. The use of parameters 4 and 5 is explained in the following discussion.

In some instances, the steepest descent path optimization procedure may prove inadequate. This is due to the fact that the gradient testing method is somewhat shortsighted. That is, it determines the optimum point at a short distance (the gradient stepsize) from its current position. In so doing, it commits an expenditure to a countermeasure that it cannot retract. It may turn out that for larger total expenditures, the optimum point exists with a lesser expenditure on a countermeasure than was previously committed to reach an optimum point earlier in the step-by-step optimization process. The previous version of Noizop would fail to find the actual optimum point in such an instance because it did not allow retraction of expenditures on any countermeasure.

The operating theory of Noizop version 2.2 to correct this potential problem is illustrated in Figure A-1.

This is a refinement stage. It is repeated the number of times designated by the "number of refinement stages" parameter or until the decision box is "Yes."

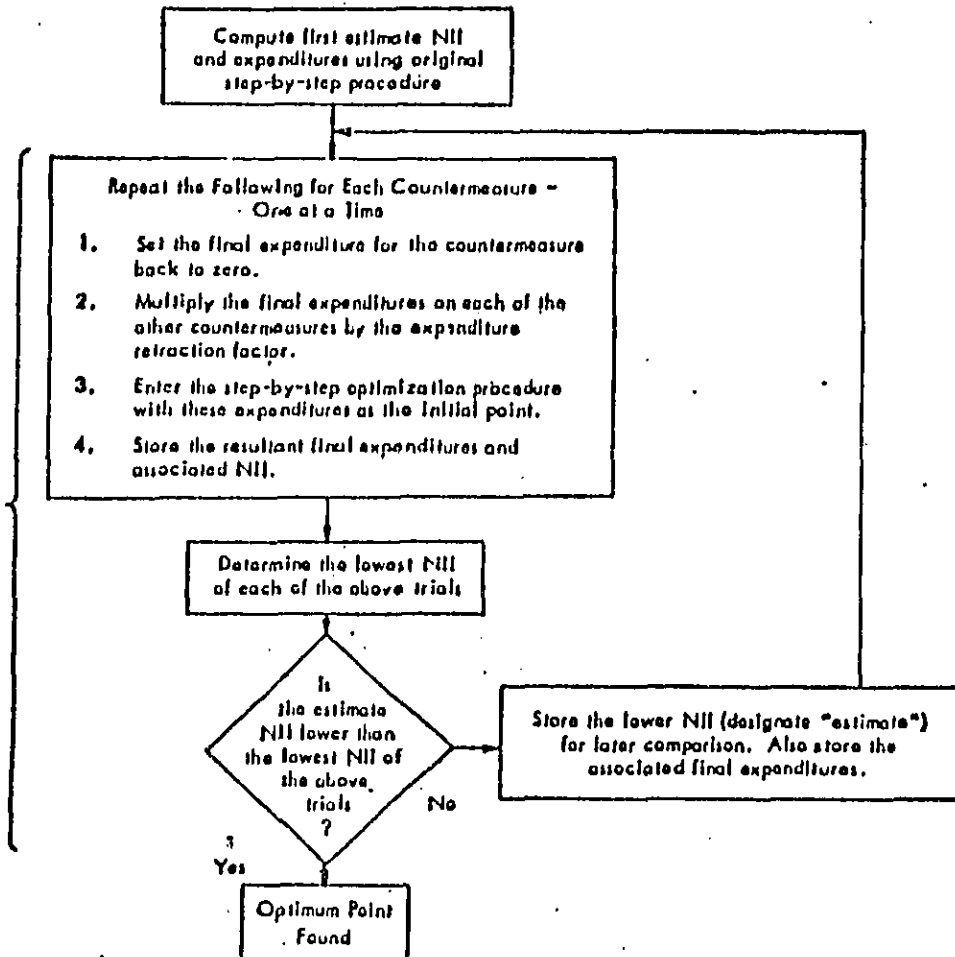

Figure A-1. Functional Flow Diagram Describing Optimization Refinement Stages (Subroutine SEARCH)

As can be seen from Figure A-1, a quantity called the expenditure retraction factor is used to adjust the estimated final expenditures on each of the other countermeasures at the time when one of them is being retracted to zero. A factor less than 1. will reduce the values, a factor greater than 1. will increase them. The default value for this parameter, initiated by a blank field or a zero, is 1. which means that the expenditure values are not altered.

The "number of refinement stages" parameter controls the maximum number of times the expenditures on each countermeasure will be retracted to zero in search of a lower NII. The process will stop automatically in the event that a refinement stage fails to improve on the best value found in the previous refinement stage. The default value for this parameter, initiated by a blank field or a zero, is zero, no refinement stages. With no refinement stages, the results of this version of Noizop will be identical to the results of the earlier version.

9. Output of Bar Graph Summarizing Results

A bar graph is now produced which graphically illustrates the final expenditures on each of the countermeasures. Both total costs (T) and user costs (U) are plotted. Due to the extreme range of dollar values which may be expended, the expenditures axis is on a logarithmic scale. Care should thus be taken in reading this chart due to the nonlinear nature of the scaling. The chart is self-adjusting on both axes; that is, it will compute the range of values that are to be plotted and allow the maximum number of print positions to display the information. A horizontal line at the top of the bar for a countermeasure indicates the spending limit was reached on that countermeasure.

A.2.2 Programmer's Guide Updates

This section updates the Noizop Programmer's Guide to reflect the changes to the program described in the preceding section. (Figure numbers referred to indicate figures in the Programmer's Guide.)

Figure B-1 should show two new paths coming from the main program to describe the subroutine linkage for each of the two new codewords. For codeword USER, the subroutine that is called is named USERRD. For codeword CORR, the subroutine is named ATTCOR. The corrected figure is shown in Figure A-2.

Figure B-2 should indicate the calling levels of the new subroutines, SEARCH, BARGPH, and UFRAC. SEARCH is called directly by the main program (NOIZOP) and controls the manner in which OPTIM, the subroutine which performs the step-by-step optimization, is called. The operation of subroutine SEARCH is illustrated in Figure A-1. The annotated program listing should be consulted for a detailed description of the new subroutines. The corrected Figure B-2 is shown in Figure A-3.

A new COMMON block was added to contain the user cost fractions for each of the 20 possible countermeasures

```
/CMFRAC/ DIST (20)
```

Another new COMMON block contains the two new optimization parameters

```
/PRINT/FRED, NIT
```

- FRED is the expenditure retraction factor.
- NIT is the number of refinement stages.

A.3 Quantification of Model for Six Sets of Hypothetical Applications

This section describes the application of Noizop to six sets of alternate input data. These cases serve to partially illustrate the application of Noizop to communities of different characteristics and, at the same time, demonstrate the level of sensitivity of optimum countermeasure application to various communities.

The base data that was used represents the quantification of an actual Northern California community. Six cases were derived as variants of that data. They are summarized in Table A-5. Figures A-4 through A-11 and Table A-7 summarize the computer output for the six cases.

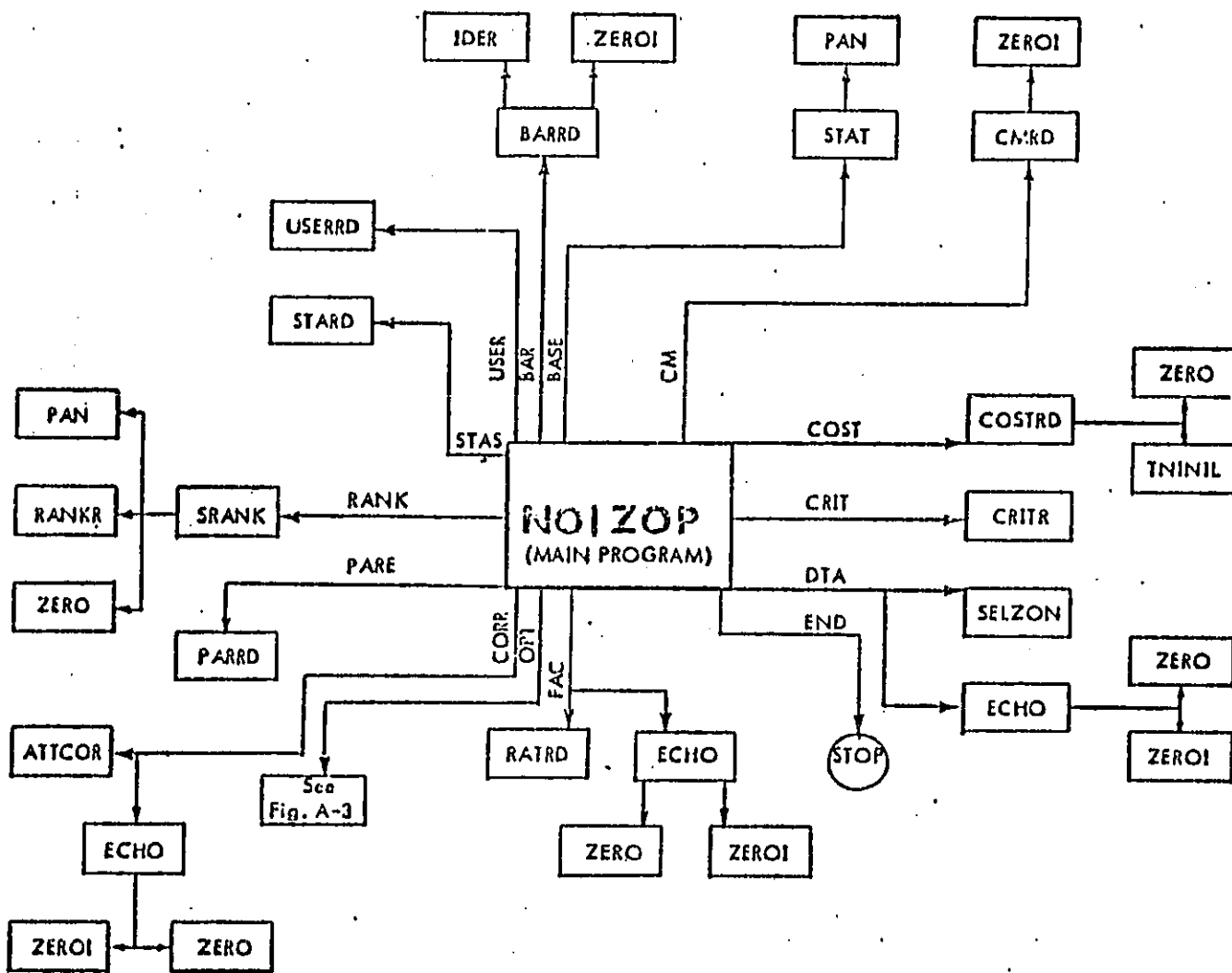

Figure A-2. Subroutine Linkage Diagram Indicating Program Flow by Codeword

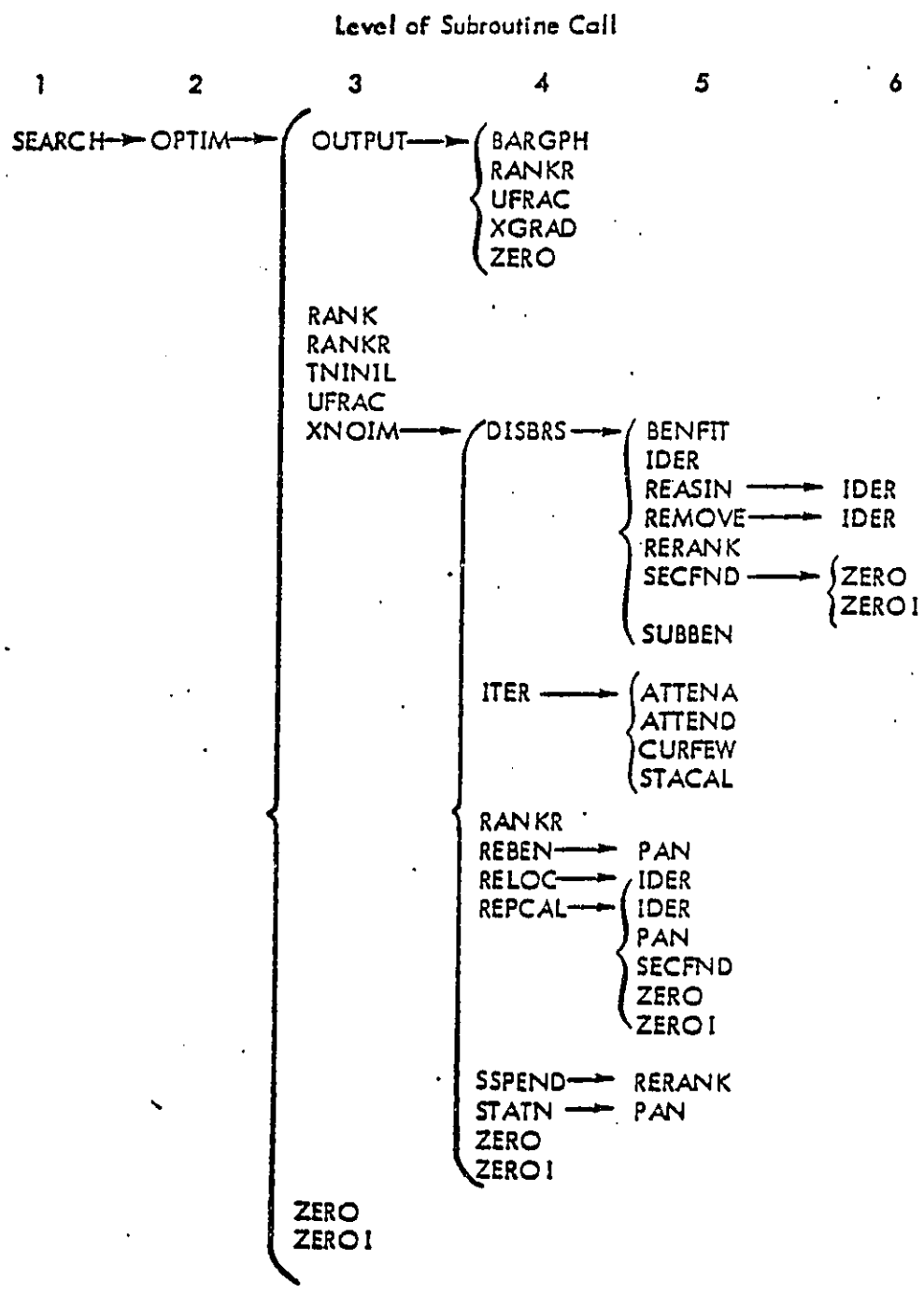

Figure A-3. Subroutine Linkages (Alphabetical Order) for the Main Optimization Process, Codeward OPT.

BEST COPY AVAILABLE

Table A-5
Alternatives Analyzed by Noizop

1. Baseline Case.
2. Two Times Residential Population Density of Baseline Case.
3. Community One-Half the Size of the Baseline Case.
4. Removing the Motorcycle Noise Source and Countermeasure.
5. Removing the Path-Receiver Countermeasure.
6. The Baseline Case without the Noise Source Attitudinal Adjustments.

1. Baseline

This case, reanalyzed for this document with a few modifications, is thoroughly described in the User's Guide, Section 5.2, where the input data is described and the complete computer output is presented. The modifications to the input data reflect the changes made to Noizop to include additional capabilities required for application by local governments. The specific changes to the input data are detailed below.

1. The countermeasure type numbers were redefined to reflect the new designations (see Table A-2). The countermeasures used in the analysis of the alternatives are listed in Table A-6.
2. The two-dimensional enforcement type countermeasures were removed; this concept presents an additional complexity beyond the scope of this manual (see User's Guide, Section 4.2).
3. The countermeasure manipulation indicators were redefined according to the new formula.
4. The linear transfer function specification allowing more than 100 percent impact was removed as this option is now default.

Table A-6

Countermeasures Defined for Noise Analysis of Alternatives

----- AUTOMOBILES LOW SPEED NEW VEHICLES SOURCE REDUCTION
COUNTERMEASURE 1 TYPE 6 'EXCL TRT' APPLIES TO: AUTOMOBILES LOW SPEED LINE SRC
AUTOMOBILES LOCAL TRAFFIC SOURCE

----- AUTOMOBILES LOW SPEED EXISTING VEHICLES RETROFIT SOURCE REDUCTION
COUNTERMEASURE 2 TYPE 6 'EXCL TRT' APPLIES TO: AUTOMOBILES LOW SPEED LINE SRC
AUTOMOBILES LOCAL TRAFFIC SOURCE

----- AUTOMOBILES LOW SPEED ODS ENFORCEMENT
COUNTERMEASURE 3 TYPE 5 'DB RED' APPLIES TO: AUTOMOBILES LOW SPEED LINE SRC
AUTOMOBILES LOCAL TRAFFIC SOURCE

----- MOTORCYCLES LOW SPEED ODS ENFORCEMENT
COUNTERMEASURE 4 TYPE 5 'DB RED' APPLIES TO: MOTORCYCLES LOW SPEED LINE SRC.
MOTORCYCLES LOCAL TRAFFIC SOURCE

----- TRUCKS LOW SPEED NEW VEHICLES SOURCE REDUCTION
COUNTERMEASURE 5 TYPE 4 'PART TRT' APPLIES TO: TRUCKS LOW SPEED LINE SRC.

----- TRUCKS HIGH SPEED TIRE NOISE REDUCTION
COUNTERMEASURE 6 TYPE 4 'PART TRT' APPLIES TO: TRUCKS HIGH SPEED LINE SRC.

----- BUSES LOW SPEED SOURCE REDUCTION, NEW AND EXISTING VEHICLES
COUNTERMEASURE 7 TYPE 5 'DB RED' APPLIES TO: BUSES LOW SPEED LINE SRC.

----- AIRCRAFT SOUND ADSORPTION MATERIAL NACELLE TREATMENT SOURCE REDUCTION
COUNTERMEASURE 8 TYPE 4 'PART TRT' APPLIES TO: AIRCRAFT COMMERCIAL, FLIGHT

----- AIRCRAFT FLIGHT PATH REROUTING (EFFECTIVELY A FLIGHT FREQUENCY RED.)
COUNTERMEASURE 9 TYPE 1 'RED FREQ' APPLIES TO: AIRCRAFT COMMERCIAL, FLIGHT

----- AIRCRAFT REDUCTION OF NIGHT OPERATIONS
COUNTERMEASURE 10 TYPE 2 'NITE RED' APPLIES TO: AIRCRAFT COMMERCIAL, FLIGHT

----- RAILROAD LOCOMOTIVE MUFFLERS, SOURCE REDUCTION
COUNTERMEASURE 11 TYPE 4 'PART TRT' APPLIES TO: RAILROAD LOCOMOTIVES, LINE S.

----- PATH-RECEIVER CONTROL: INSULATION, BARRIERS, LAND ACQ. AND PEOPLE RELOC.
COUNTERMEASURE 12 TYPE 8 'P-R MOD' APPLIES TO: ALL SOURCES

A-16

BEST COPY AVAILABLE

5. The specification of upper and lower criterion levels was removed as this information is now default.
6. Attitudinal adjustments with the following parameters were made to low speed arterial and local traffic (collector streets), motorcycle and locomotive and car railroad noise sources (numbers 6, 7, and 9, 10, respectively).

<u>Source</u>	<u>Adjustment, dB</u>
Motorcycles	-6. (Increase)
Railroad	5. (Decrease)

These hypothetical adjustments compensate for the fact that the annoyance reaction to motorcycle noise is indicative of a noise level 6 dB higher than for other sources. The railroad correction illustrates that a noise level of 5 dB greater than for the other sources is required to produce a comparable annoyance reaction.

7. Hypothetical user cost fractions were entered as shown below for countermeasures 1 through 12, respectively.

Counter- measure Number												
	1	2	3	4	5	6	7	8	9	10	11	12
User Cost Fraction	.01	0.	1.	0.5	.01	0.5	.01	.01	.01	.01	.01	1.

8. The total budget was specified as \$1 million and the gradient stepsize and initial maximum expenditure ratio were allowed to default to \$10 thousand and 10., respectively. No marginal search (expenditure retraction stages) was initiated.

The results of the optimization procedure are shown in Figure A-4. The path-receiver countermeasure absorbed nearly 80 percent of the total budget. The total user cost is therefore high because the local government, in this hypothetical example, is assumed to be responsible for the entire cost of path-receiver countermeasures (countermeasure number 12 above). Other significant aspects of the optimized baseline expenditures are:

- Maximum amounts were spent on countermeasures for existing automobile retrofit source reduction and enforcement thereof. An equal amount was spent on new vehicle source reduction, but this did not represent the maximum allowed expenditure. The motorcycle countermeasure, an enforcement action to eliminate the very noisy offenders, received the maximum allotment.
- A large amount was spent on both truck noise countermeasures with the high speed tire noise source receiving the maximum allowed expenditure.
- The bus noise countermeasure did not receive any funding but was the highest ranking countermeasure at the end of the optimization process. Therefore, if additional funds were available, the bus noise countermeasure would be the next to receive funding, assuming, of course, that the additional funds would either be insufficient for an additional discrete path-receiver expenditure or that next path-receiver measure would be less effective than the bus noise countermeasure.
- The only aircraft countermeasure selected was flight path routing. The rerouting of all the aircraft accounts for the subsequent ineffectiveness of both the Sound Absorbing Material (SAM) and night curfew countermeasures.

FINAL EXPENDITURES ON EACH COUNTERMEASURE

NII = .1987

Percent Reduction = 73 Percent

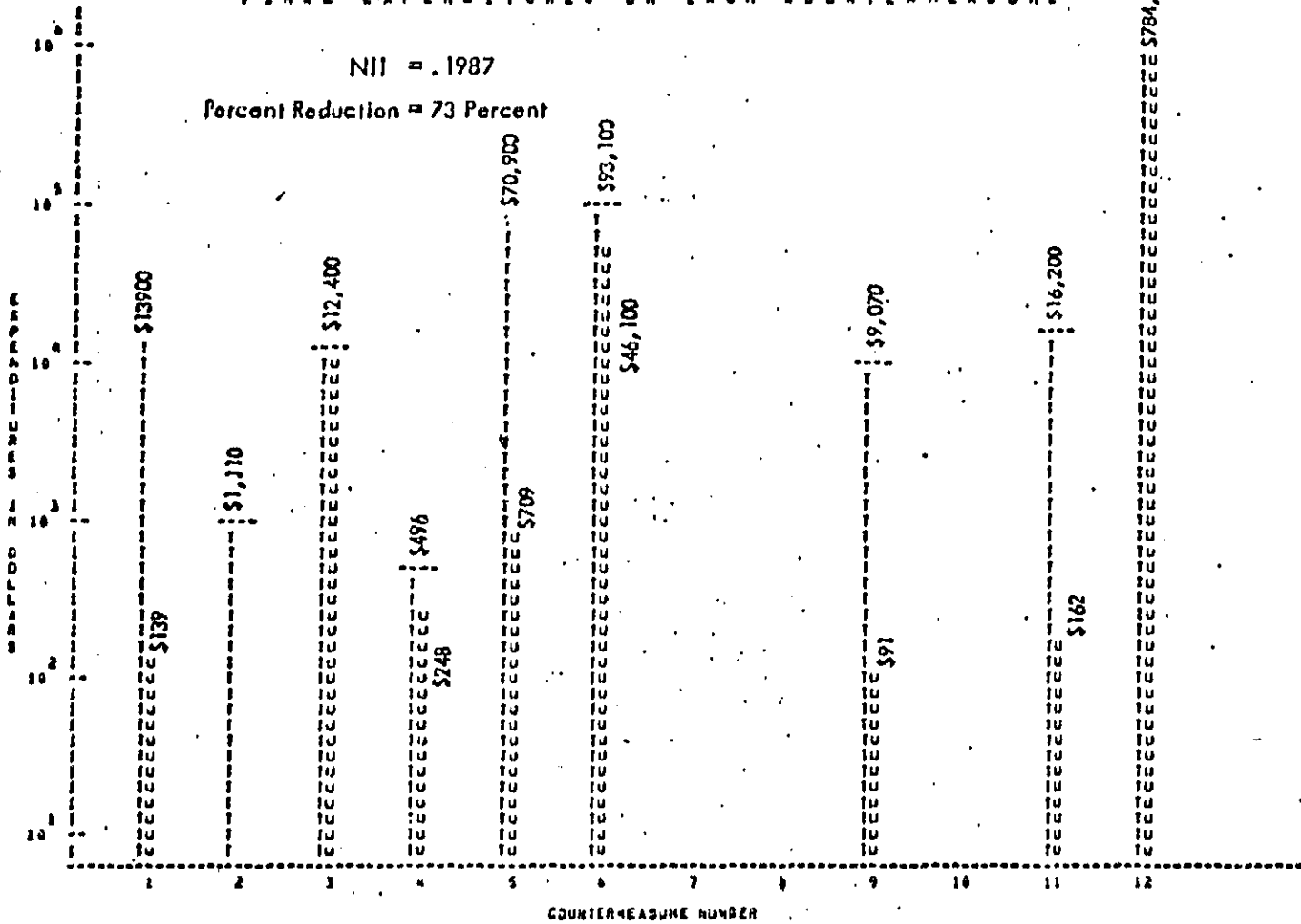

Figure A-4. Baseline Case Optimization Results. T = Total Cost = \$1,000,000; U = User Cost = \$844,000.

Table A-7

Extent of Countermeasure Application to the Six Hypothetical Examples.
The Countermeasure Application Corresponds to Total Expenditures
on Each Countermeasure as Seen in Figures A-4 through A-7 and A-10 through A-11

Countermeasure	Case					
	1 Baseline	2 Twice Residential Population Density	3 Community One-Half Site	4 Removing Motorcycle Source and Countermeasure	5 No Path-Receiver Countermeasure, Smaller Budget	6 No Attitudinal Adjustments
1. Percent of Automobiles Receiving 3.5 dB Reduction*	16%	19%	1%	13%	0	20%
2. Percent of Automobiles Receiving 3.5 dB Reduction*	57%	57%	57%	57%	57%	57%
3. Decibel Reduction in Automobile L_{eq} due to Enforcement of Ordinance	6.2 dB	6.2 dB	6.2 dB	6.2 dB	5.9 dB	6.2 dB
4. Decibel Reduction in Motorcycle L_{eq} due to Enforcement of Ordinance	17 dB	17 dB	17 dB	—**	17 dB	17 dB
5. Percent of Trucks Receiving 12 dB Engine Noise Reduction	36%	36%	36%	36%	25%	36%
6. Percent of Trucks Receiving 5 dB Tire Noise Reduction	100%	100%	100%	100%	33%	100%
7. Decibel Reduction in Bus L_{eq}	0	0	0	5.1 dB	0	0
8. Percent of Aircraft Receiving SAM Treatment	0	0	0	0	0	0
9. Percent of Aircraft Rerouted	100%	100%	100%	100%	100%	100%
10. Percent of Aircraft Night Operations Eliminated	0	0	0	0	0	0
11. Percent of Railroad Locomotives Receiving 6 dB Muffler Treatment	100%	100%	100%	100%	100%	100%
12. Total Dollar Expenditure on Barriers and Soundproofing	\$784,000	\$775,000	\$791,000	\$775,000	—**	\$773,000

*Countermeasures 1 and 2 are mutually exclusive (Countermeasure Type 6). Countermeasure 1 applies to new vehicles, Countermeasure 2 applies to existing vehicles.

**Countermeasure not defined.

- The railroad countermeasure applying to the locomotive source also received maximum funding which is consistent with the high source ranking of the locomotive noise source (see Figure A-8).

2. Two-Times Residential Population Density of Baseline Case

The data set for this case is identical to the data set for case number 1 with the exception that every cell in a residential land use area has double the baseline population.

The results of this case, shown in Figure A-5 show almost the same results as for case number 1., the difference being that the low speed automobile source received slightly more treatment at the expense of a path-receiver countermeasure.

3. Community One-Half the Size of the Baseline Case

For this alternative, every other cell defined for the baseline case was removed to simulate a smaller community. As can be seen in Figure A-6, the results are quite similar to the baseline case. The detailed disposition of the individual path-receiver measures (i.e., barriers and soundproofing) was, of course, quite different since the configuration of the community and, hence, the relative cost-effectiveness of all the possible individual path-receiver measures is different.

4. Removing the Motorcycle Noise Source and Countermeasure

Removing the motorcycle source has the effect of slightly altering the community so that an expenditure on the bus countermeasure becomes effective. No other significant differences from the baseline case are present. Figure A-7 illustrates the results. Note that the motorcycle countermeasure (number 4) was removed for this case meaning that in Figure A-7, countermeasures numbered 4 through 11 correspond to countermeasures numbered 5 through 12 in the five other cases.

An interesting result of removing the motorcycle source is a change in the population-weighted noise source impact ranking in the community. Figure A-8 is the source ranking for the baseline case, including the motorcycle source. Figure A-9 is the source ranking with the motorcycle source removed.

FINAL EXPENDITURES ON EACH COUNTERMEASURE

NII = .2225

Percent Reduction = 71 Percent

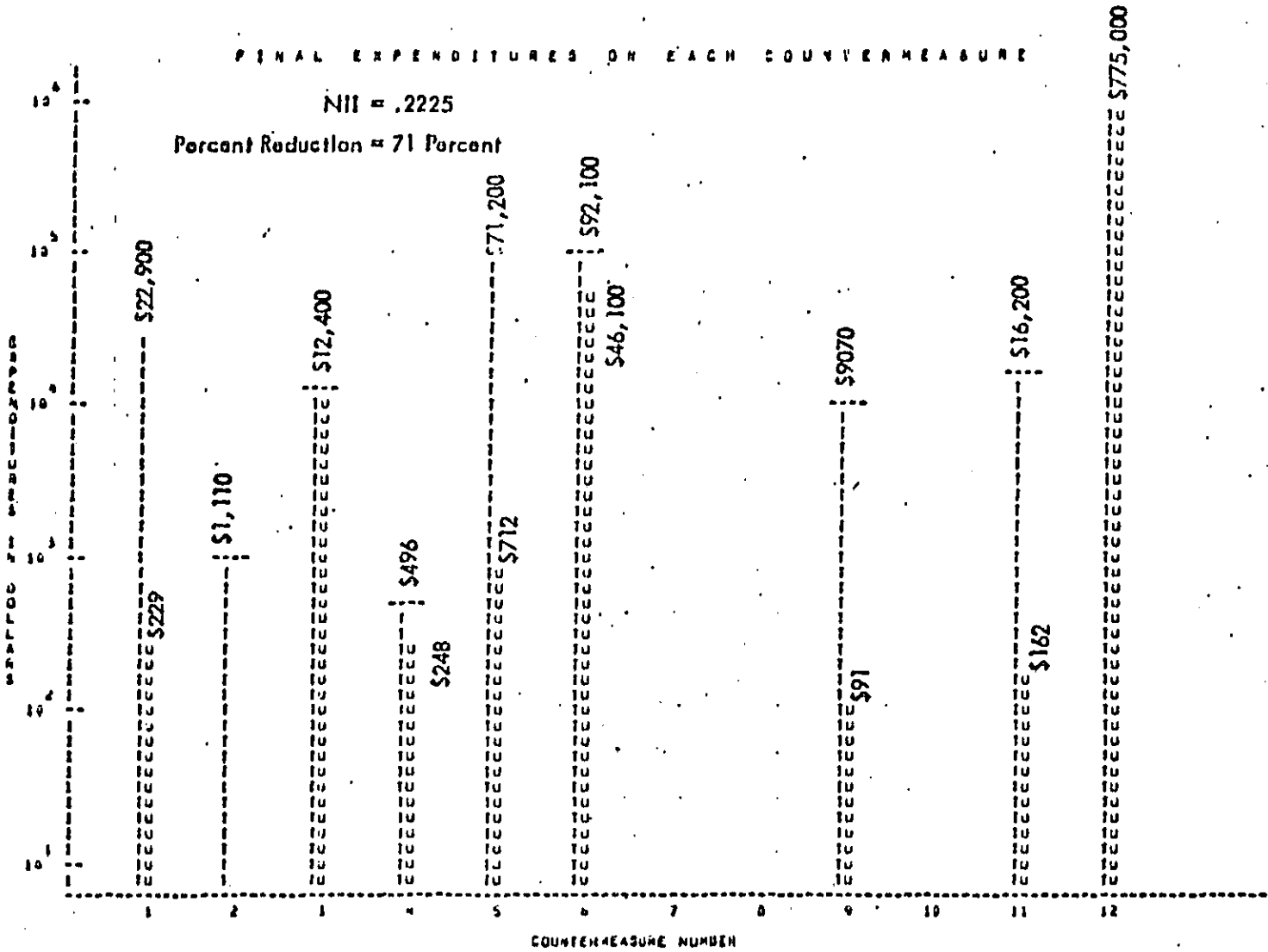

Figure A-5. Final Expenditures for Case Number 2, Two Times Residential Population Density of Baseline Case
 Total Cost = \$1,000,000; User Cost = \$834,000

FINAL EXPENDITURES ON EACH COUNTERMEASURE

NII = .0629

Percent Reduction = 89 Percent

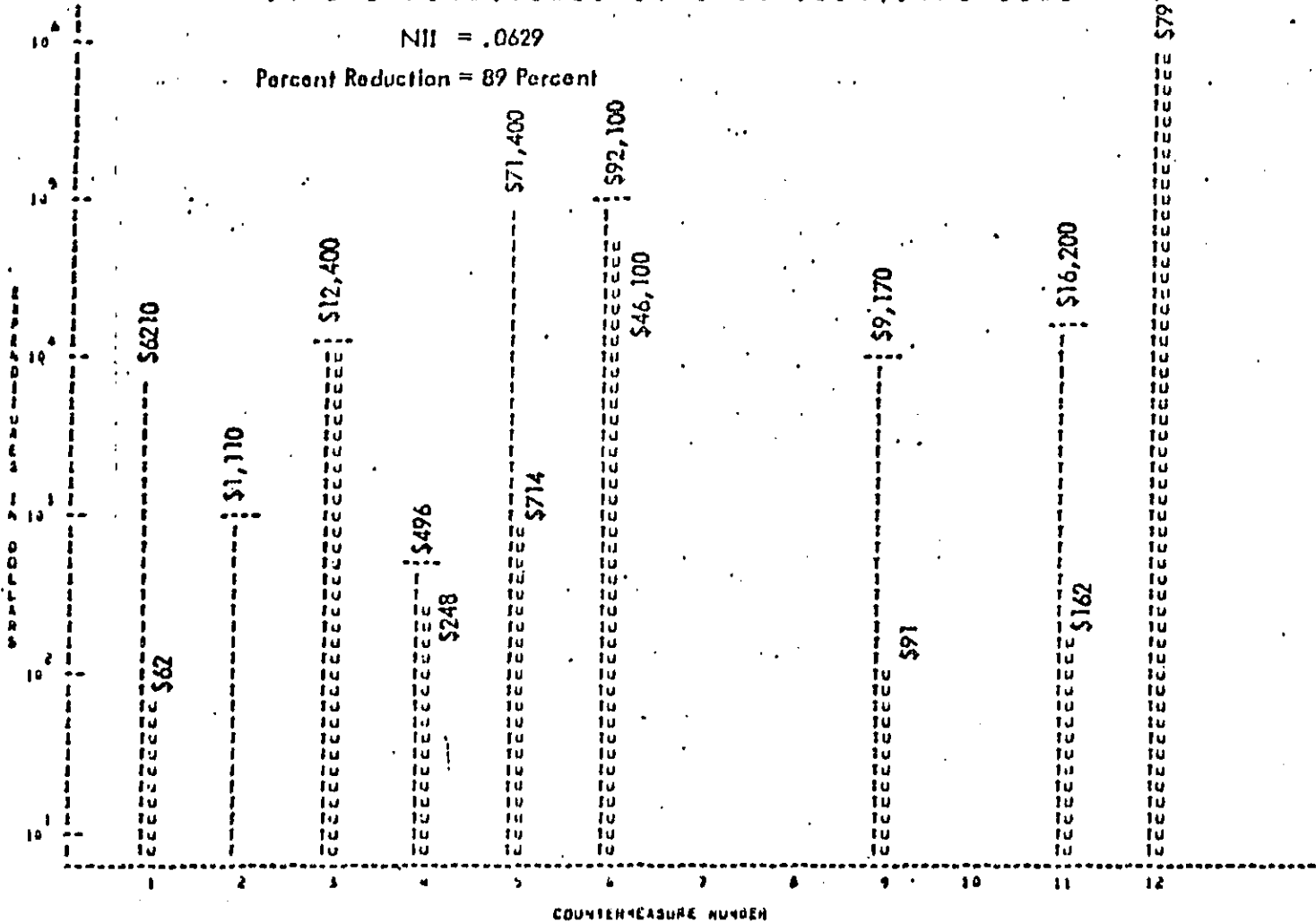

Figure A-6. Final Expenditures for Case Number 3; Community One-Half the Size of the Baseline Case
Total Cost = \$1,000,000; User Cost = \$851,000

FINAL EXPENDITURES ON EACH COUNTERMEASURE

NII = .1881

Percent Reduction = 62 Percent

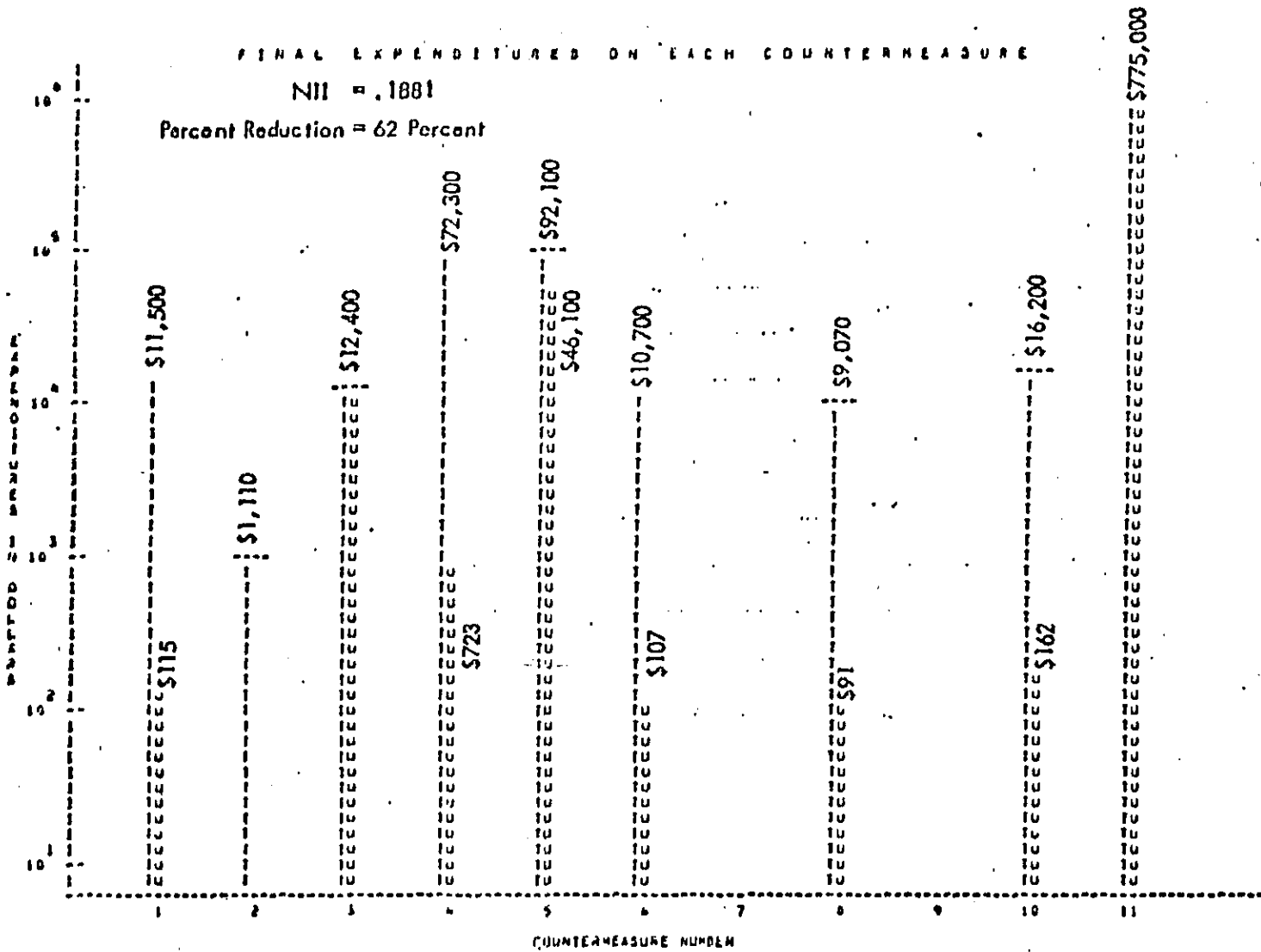

Figure A-7. Final Expenditures for Case Number 4, Removing the Motorcycle Noise Source and Countermeasures
 Total Cost = \$1,000,000; User Cost = \$834,000

MOST OFFENDING SOURCES:			SOURCE NO.
1	MOTORCYCLES	LOW SPEED LINE SRC.	(6)
2	MOTORCYCLES	LOCAL TRAFFIC SOURCE	(7)
3	RAILROAD	LOCOMOTIVES, LINE S.	(9)
4	AUTOMOBILES	LOW SPEED LINE SRC	(1)
5	TRUCKS	LOW SPEED LINE SRC.	(4)
6	TRUCKS	HIGH SPEED LINE SRC.	(5)
7	AUTOMOBILES	HIGH SPEED LINE SRC	(2)
8	AUTOMOBILES	LOCAL TRAFFIC SOURCE	(3)
9	RAILROAD	CARS, LINE SOURCE	(10)
10	AIRCRAFT	COMMERCIAL, FLIGHT	(11)
11	BUSES	LOW SPEED LINE SRC.	(8)

Figure A-8. Noise Source Ranking of Baseline Case

MOST OFFENDING SOURCES:			SOURCE NO.
1	AUTOMOBILES	LOW SPEED LINE SRC	(1)
2	TRUCKS	LOW SPEED LINE SRC.	(4)
3	TRUCKS	HIGH SPEED LINE SRC.	(5)
4	RAILROAD	LOCOMOTIVES, LINE S.	(9)
5	AUTOMOBILES	HIGH SPEED LINE SRC	(2)
6	AUTOMOBILES	LOCAL TRAFFIC SOURCE	(3)
7	RAILROAD	CARS, LINE SOURCE	(10)
8	AIRCRAFT	COMMERCIAL, FLIGHT	(11)
9	BUSES	LOW SPEED LINE SRC.	(8)

Figure A-9. Noise Source Ranking with Motorcycle Source Removed

BEST COPY AVAILABLE

Prior to the removal of the dominant motorcycle sources, the railroad locomotive noise source had a greater impact than the low speed automobile source and both the low and high speed truck noise sources. The counterintuitive result of removing the motorcycle source is that the automobile and truck noise source now have greater impact relative to the railroad locomotive source than they did before.

An apparent explanation is that the presence of the annoying motorcycle source had the effect of masking the automobile and truck sources. In other words, with the motorcycles no longer there, the automobiles and trucks become the dominant sources in areas where traffic is dominant, but the number of areas impacted by railroad noise remains unchanged.

5. No Path-Receiver Countermeasure

Since the path-receiver countermeasures received the preponderance of the expenditure allocation in the other cases, the removal of this countermeasure provides potentially the most interesting variant to the baseline case. For this case, the total budget was reduced to \$100 thousand since a \$1 million budget would allow maximum application of all the countermeasures and no interesting results would be obtained. Figure A-10 illustrates these results.

Countermeasure number 1, new automobile source reduction, now receives no expenditures while the remainder is disbursed to countermeasures 3, 5, and 6 (see Table A-6). Overall, the disposition of these countermeasures is similar to the baseline case. What this case illustrates is that, for this community, the optimum expenditures among the remaining countermeasures is only slightly altered when the most cost-effective countermeasure is removed.

6. No Attitudinal Adjustments

Removing the attitudinal adjustments had little effect since the motorcycles and railroad noise source predominate even without the attitudinal corrections. The effect of the attitudinal corrections was to increase the apparent motorcycle levels by

FINAL EXPENDITURES ON EACH COUNTERMEASURE

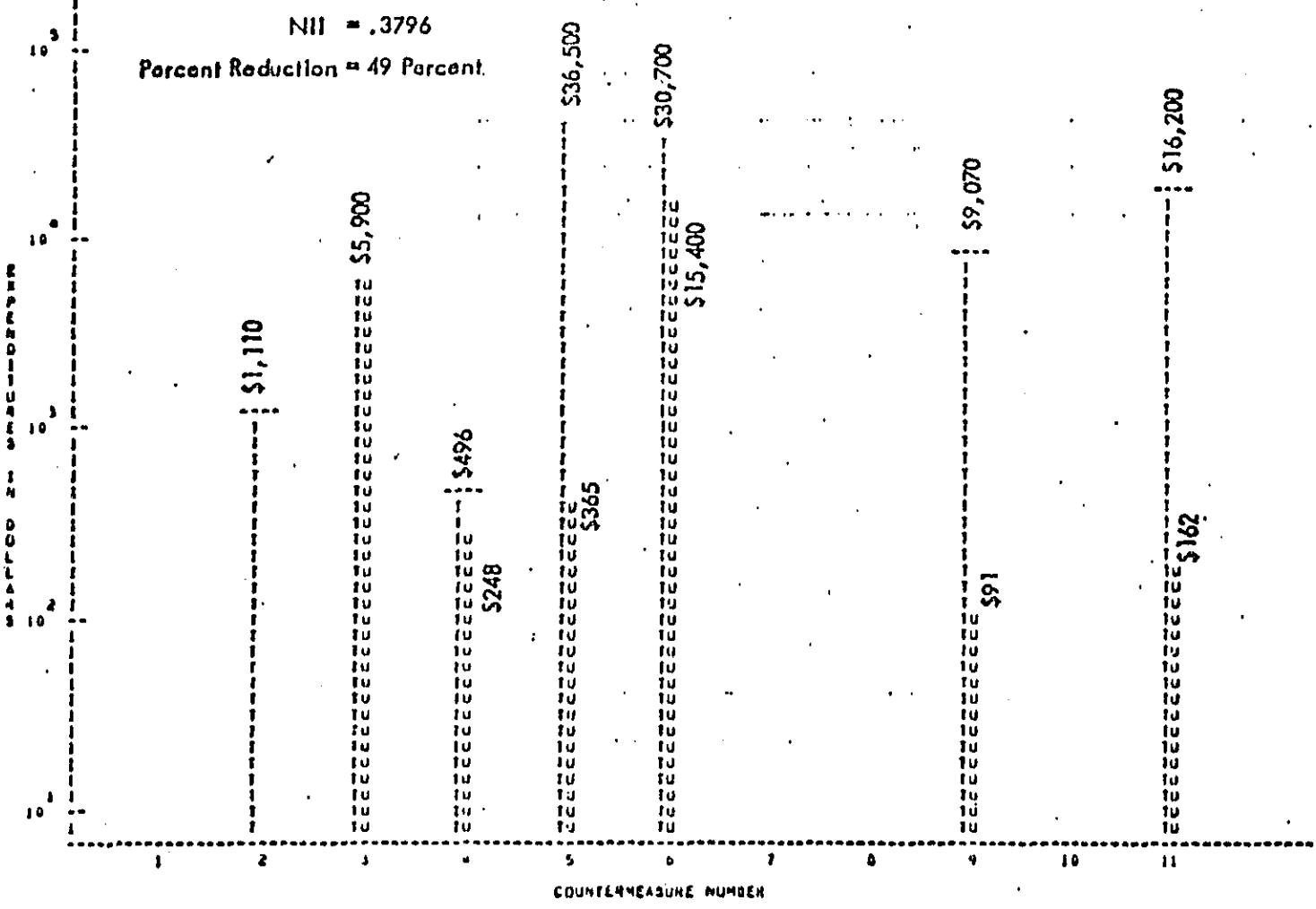

Figure A-10. Final Expenditures for Case Number 5, No Path-Receiver Countermeasure
Total Cost = \$100,000; User Cost = \$22,100

6 dB, and decrease the apparent railroad source levels by 5 dB. With these adjustments removed, the motorcycle countermeasure still remains very effective and the effectiveness of the railroad countermeasure is not altered sufficiently to make a noticeable difference. Countermeasures 1 and 5 received slightly more funding at the expense of path-receiver measures. Figure A-11 summarizes the results.

FINAL EXPENDITURES ON EACH COUNTERMEASURE

NII = .2323

Percent Reduction = 69 Percent

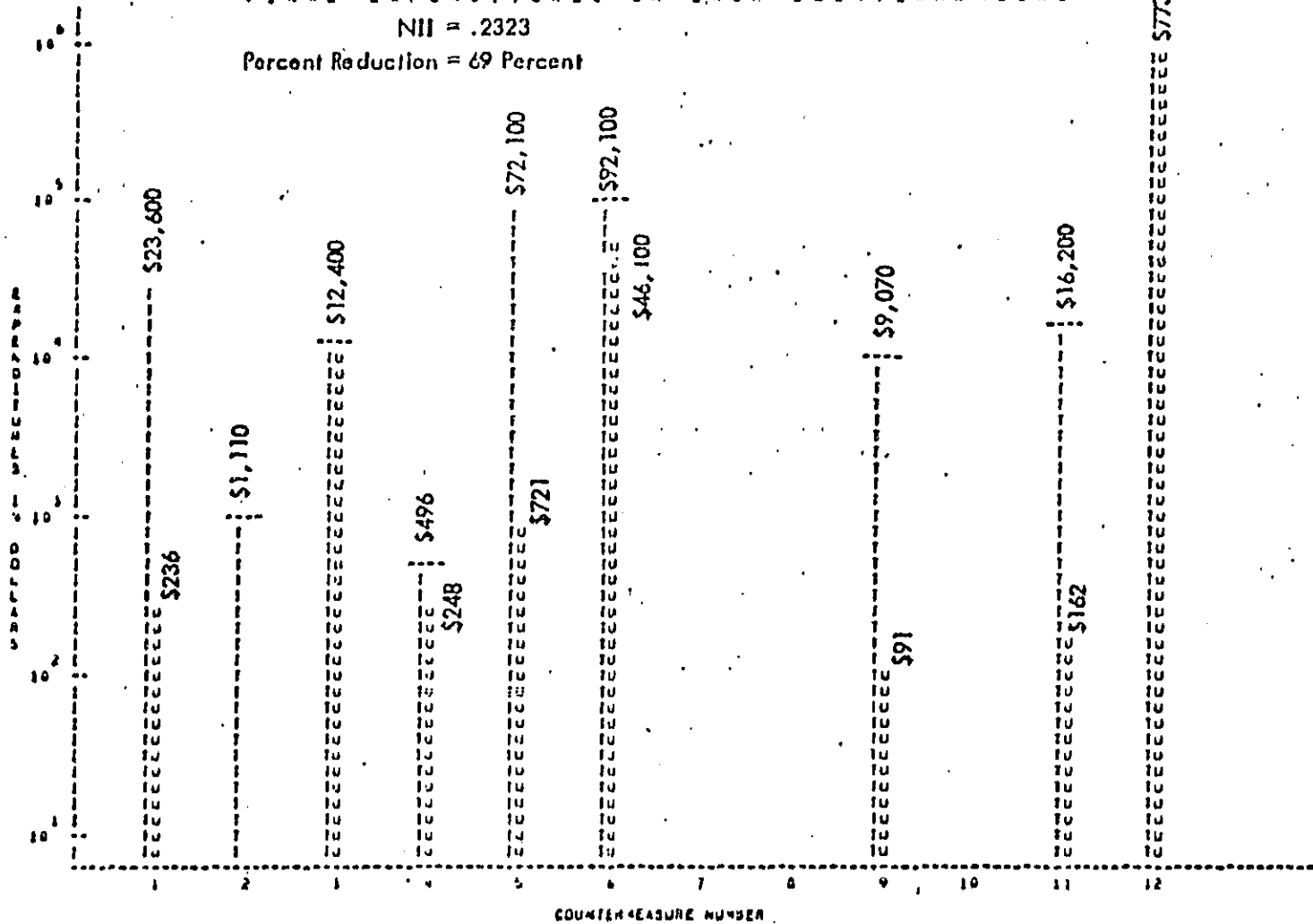

Figure A-11. Final Expenditures for Case Number 6, No Attitudinal Adjustments
 Total Cost = \$1,000,000; User Cost = \$833,000

*Duplicate Copy
G. M. H. Hawley*

A.4 Summary of the Allentown Strategy Analysis

The results of applying methods developed in the Community Noise Strategy Guidelines Manual to the city of Allentown, Pennsylvania, are summarized in this section of Appendix A. In conjunction with EPA and Allentown, problem noise sources were identified on the basis of acoustical, attitudinal, and complaint information, and a list of countermeasures was derived which were felt to be the most promising and practical means of abating these sources. The costs incurred by society and the noise reductions achieved with each of the selected countermeasures were estimated from data supplied by Allentown, using methods described in the Strategy Guidelines Manual.

The noise optimization program, Noizop, was then used to find optimal degrees of societal expenditure on each of the selected countermeasures for various overall spending limits. In particular, optimal expenditure strategies were found which would provide the maximum reduction in impacts from noise (1) in the year 1980 and (2) in the year 1988, for a nominal expected city noise control budget, as suggested by Allentown Quiet Communities Program Staff. These results are presented and discussed below. The main findings are:

- The most cost-effective countermeasures are (1) those which abate emergency vehicles, since the cost of abating this source is very low, and (2) those which abate automobiles, since this source is both the most pervasive in Allentown (as was indicated by the acoustical survey) and also one of the most annoying (according to the attitudinal survey). Although it is not known whether the main problem of automobile noise is caused by a few noise modified vehicles (which are the main target of automobile noise countermeasures in this analysis) or by the more numerous but quieter majority, it is suggested that additional countermeasures not considered in this analysis which can help reduce noise impacts from this source should be investigated in the future.

- Very little difference is observed between expenditures optimized in 1980 vs. expenditures optimized in 1988, since most countermeasures are expected to take effect immediately (1978) and remain unchanged thereafter.
- A budget which is approximately 1/3 lower than the present budget anticipated by the city of Allentown may be more desirable, as measured in terms of the cost per reduction of noise impacts which can be achieved.

Inputs

The countermeasures analyzed in the optimization program are described below.

1. Property Standard applied to Noise from Garden Equipment and People.
This property standard would set noise emission limits at the property line of between 75 and 80 dB for one hour due to noise from garden equipment or activity by people (i.e., playing loud music, etc.)
2. Noise Ordinance Applied to Motorcycles.
A noise ordinance was considered which would consist of four parts:
 - (1) Enforcing the federal new vehicle standard on motorcycles (83 dB in 1978, 80 dB in 1980)*
 - (2) Enforcing the Pennsylvania Department of Transportation (Penn DOT) low speed operational regulations on motorcycles (84 dB)
 - (3) Enforcing operational controls (reducing excess accelerations)
 - (4) Enforcing an equipment standard (e.g., "all motorcycles shall have proper mufflers")
3. Noise Ordinance Applied to Autos.
A noise ordinance applied to autos was considered which would consist of three parts:

*All regulation limits given are maximum low speed passby levels measured at 15 m.

- (1) Enforcing the Penn DOT low speed operational regulations on autos (84 dB)
- (2) Enforcing operational controls (reducing excess accelerations)
- (3) Enforcing an equipment standard (e.g., "all autos shall have proper mufflers")

4. Noise Ordinance Applied to Trucks.

A noise ordinance applied to trucks was considered which would consist of four parts:

- (1) Enforcing the federal new vehicle standard on trucks (83 dB in 1978, 80 dB in 1980)
- (2) Enforcing the Penn DOT low speed operational regulations on trucks (88 dB)
- (3) Enforcing operational controls (reducing excess accelerations)
- (4) Enforcing an equipment standard (e.g., "all trucks shall have proper mufflers")

5. Noise Ordinance Applied to Buses.

A noise ordinance applied to buses was considered which would consist of four parts:

- (1) Enforcing the proposed federal new vehicle standard on buses (83 dB in 1979, 80 dB in 1983, and 77 dB in 1985)
- (2) Enforcing the Penn DOT low speed operational regulations on buses (88 dB)
- (3) Enforcing operational controls (reducing excess idling near residences)
- (4) Enforcing an equipment standard (e.g., "all buses shall have proper mufflers")

6. **Operational Controls Applied to Emergency Vehicles.**
This countermeasure would reduce the amount of time sirens are used by restricting their use to emergency situations.
7. **New Vehicle Standard Applied to Garbage Trucks.**
This noise standard would enforce federal noise regulations on newly manufactured garbage trucks (78 dB in 1979, 75 dB in 1982)
8. **Mode Transfer from Autos to Buses.**
This countermeasure would use education and advertisement media to get more commuters to use buses instead of autos.
- 9-13. **Education and Complaint Mechanism Applied to (9) Autos and Motorcycles, (10) Trucks and Buses, (11) Garbage Trucks and Emergency Vehicles, (12) Garden Equipment and People, and (13) Pets**
These countermeasures have to do with informing the public about the causes and effects of community noise and establishing a mechanism such as a noise "hot line" which the public can use to complain about noisy sources such as motorcycles, private parties, or industrial plants.
14. **Stationary Source Controls Applied to Fairgrounds.**
This countermeasure would reduce noise emissions from equipment and loud music typically found at fairs.
15. **Stationary Source Controls Applied to Music Clubs.**
This countermeasure would reduce the undesirable source of music clubs propagating into nearby residential areas by requiring owners to provide sound insulation treatment of the exterior walls of their clubs.
16. **Building Insulation and Codes.**
Twenty areas ("cells") throughout the city were selected as potential candidates for building insulation treatment. The noise optimization program was then allowed to pick the cells which needed insulation.

In addition to inputs which defined the above potential countermeasures, an annual noise control budget of \$123,000 for the city government of Allentown was selected. This number is based on the man-year estimates provided by the city shown in Table A-8.

Table A-8
Manpower Distribution Estimated by Allentown for
Various Noise Control Activities, Man-years

Noise Control Activity	Government Entity Performing Activity			
	QCP	Police	Information Services	Community Planners
Stationary Source Control	1/2	-	-	-
Motor Vehicle Noise Enforcement	1	2	-	-
Education and Complaint Activities	1	-	1/2	1/2
Bus Ridership Campaign	1/2	-	-	-
Building Insulation Program	1	-	-	-

Total = 7 man-years

The total costs defined for each countermeasure include all costs incurred by society. To find the costs incurred by Allentown's city government alone, a "City Fraction" was estimated for each countermeasure. These city fractions are shown in Table A-9. Note that some of the countermeasures are expected to be paid for almost entirely by Allentown (such as the Bus Noise Ordinance), while others only involve relatively minor government expense (such as a building insulation program).

Outputs

The optimum total (T) and city government (U) expenditures selected by Noiseop for each countermeasure at the city budget level defined above are shown

Table A-9

Effectiveness of Countermeasures in the Allentown Strategy Analysis

No.	Countermeasure	Noise Source Affected	City (2) Fraction	Cost/Effectiveness (Percent of Maximum Allowable Expenditure)		Comments
				1980	1988	
1	Property Standard	Garden Equipment, People	0.995	0%	0%	Not very cost/effective
2	Noise Ordinance (1)	Motorcycles	0.25	51	51	Less should be spent on this countermeasure as budget increases
3	Noise Ordinance (1)	Autos	0.84	100	100	Very cost/effective
4	Noise Ordinance (1)	Trucks	0.11	100	49	Cost/Effective - in 1980, additional money should be spent here next
5	Noise Ordinance (1)	Buses	1.00	0	100	Only cost/effective in the long term
6	Operational Control	Emergency Vehicles	1.00	100	100	Very cost/effective
7	New Vehicle Standard	Garbage Trucks	0.09	0	100	Only cost/effective in the long term
8	Mode Transfer	Autos, Buses	1.00	100	100	Very cost/effective
9	Education and Complaint Mechanism	Autos, Motorcycles	1.00	100	100	Very cost/effective
10	Education and Complaint Mechanism	Trucks, Buses	1.00	0	0	Not cost/effective
11	Education and Complaint Mechanism	Garbage Trucks, Emergency Vehicles	1.00	100	100	Very cost/effective
12	Education and Complaint Mechanism	Garden Equipment, People	1.00	85	86	Quite cost/effective
13	Education and Complaint Mechanism	Pets	0.48	100	100	Very cost/effective
14	Stationary Source Controls	Fairgrounds	0.54	0	0	Not cost/effective
15	Stationary Source Controls	Music Clubs	0.37	0	0	Not cost/effective
16	Building Insulation and Codes	All Sources	0.04	5	5	Only cost/effective at high levels of expenditures

(1) Includes: New Vehicle Standard (except for Autos), Operational Standard, Operational Controls, and Equipment Standard

(2) Fraction of countermeasure costs incurred by the City of Allentown.

in Figures A-12 and A-13 for the years 1980 and 1988, respectively. Note that the costs shown in these figures are "total discounted dollars," with an assumed discount rate of 10 percent. These costs indicate the total amount of money which is needed for each countermeasure, from now until infinity. To find the equivalent annual cost, divide these costs by 11. For example, when the optimization is made in 1980 (Figure A-12), the optimal annual expenditure on Countermeasure No. 2 is $50,000 \div 11 = \$4550$. A discussion of present value analysis and discounted costs is provided in Section 3.4 of the Strategy Guidelines Manual.

As a supplementary submittal, two additional Naizop runs are provided. Figure A-14 shows the optimum expenditure strategy in 1980 if no building insulation program is allowed. The same input data and budget are used here as were used in Figure A-12. Finally, Figure A-15 shows the expenditure pattern at a somewhat reduced budget (an annual city budget of \$82,000 instead of \$123,000). This budget seems to be a more desirable one for the countermeasures under consideration, since much less reduction in noise impacts can be achieved per dollar above this point. These results are discussed in more detail below.

Discussion of Results

The cost/effectiveness of each countermeasure is evaluated in Table A-8 above in terms of the percent of maximum allowable expenditure which Naizop chose to spend. A maximum allowable expenditure was defined for each countermeasure and supplied as input information, based on practical, technical, and economic grounds. The implications of these cost/effective percentages is discussed below for each countermeasure.

1. Property Standard applied to Garden Equipment and People

- Noizcap did not choose this countermeasure in either 1980 or 1988. This is probably due to the fact that noise levels from garden equipment and people were fairly low compared to other noise sources, due to their intermittent and transitory nature. When the building insulation countermeasure is eliminated from consideration, some money is spent on this measure (Figure A-14), but only a relatively small amount (\$2640 per year).
- Implication - A property line standard against garden equipment and people noise is not cost effective.

2. Noise Ordinance applied to Motorcycle

- This countermeasure is relatively cost/effective at low expenditure levels, but decreases in comparison with other measures as expenditures increase.
- Implications - A motorcycle noise ordinance is warranted and will be effective even if relatively mild restrictions are enforced. This is because a small percent of the motorcycles produce noise levels which are much higher than the average motorcycle levels. As a result, even a simple equipment standard requiring "proper mufflers" should have immediate benefit, as long as it is adequately enforced.

3. Noise Ordinance applied to Autos

- The maximum allowable expenditure was reached, indicating that automobile noise reduction should be a primary target for the city of Allentown. The maximum expenditure corresponds to an operational regulation level of 74 dB, which is 10 dB lower (more strict) than the present Pennsylvania DOT noise regulation.

3. Noise Ordinance applied to Autos (Continued)

- Implications - Allentown may wish to establish standards for automobiles more strict than existing state standards. These standards should probably be directed first at autos which have modified, improper, or inadequate exhaust systems. A fairly strict equipment standard which specifies allowable exhaust modifications and minimum insertion loss values for replacement parts may be very effective in this regard. To abate the impacts of the general automobile population, alternate strategies must be used, some of which lie outside the municipal government's domain. These countermeasures might include traffic controls on minor residential streets, rerouting certain major boulevards to less populous areas, and barriers located in strategic positions.

4. Noise Ordinance applied to Trucks

- Maximum expenditure limits were reached in the 1980 run, but other countermeasures were found to be somewhat more cost effective in 1988.
- Implications - A truck noise ordinance, paralleling Federal and State standards, is worthwhile at the present time, but may be deemphasized in the future.

5. Noise Ordinance applied to Buses

- While no expenditures were made for the 1980 case, the maximum expenditure limit was reached in 1988 since more quiet new buses are expected to be operating in the fleet by that time.
- Implications - Allentown should consider enforcing Federal bus noise regulations as they become more strict in the future. (Note: Federal bus noise regulations are still in the proposal stage).

6. Operational Controls applied to Emergency Vehicles

- This countermeasure received maximum allotment in both analysis years, corresponding to a reduction of 20 percent of the time sirens normally are operating.
- Implications - An emergency vehicle operational control should be implemented which would reduce unnecessary siren use as much as possible.

7. New Vehicle Standard applied to Garbage Trucks

- Similar to Countermeasure No. 5 above.
- Implications - Same as No. 5 above.

8. Mode Transfer from Autos to Buses

- It was found that the cost to society is less if commuters use buses rather than autos, therefore this countermeasure has a "negative cost".
- Implications - Commuters should be urged to ride buses through educational campaigns and increased bus service. A doubling of the bus fleet still saves society money, according to this limited analysis.

9, 11, 13. Education and Complaint Mechanism applied to (9) Autos and Motorcycles, (11) Garbage Trucks and Emergency Vehicles, and (13) Pets.

- The results for each of these countermeasures was the same, namely, the maximum allowable expenditure was reached.
- Implications - Education and complaint programs should be geared to the above 5 sources of noise. Increased manpower assignments may be warranted in this area, compared with the nominal values suggested by Table A-9 above. As with Countermeasures Nos. 2 and 3 above, for automobiles and motorcycles, the most effective results can be achieved

if attention is paid primarily to those vehicles which have modified or inadequate exhaust systems.

10. Education and Complaint Mechanism applied to Trucks and Buses

- No expenditures were made on this countermeasure. This is probably due to the fact that in Allentown, the major truck routes are well defined, therefore trucks and buses do not affect people as much near their homes, where people are more likely to complain, as they do when people are in transit. Similarly, educational programs directed at bus and truck operators are expected to change their operational habits to a lesser degree, and therefore will reduce noise levels to a lesser degree, than programs directed to more alterable causes of noise such as accelerating or modified autos and motorcycles, unnecessary sirens, or barking dogs.
- Implications - Little effort should be expended on this countermeasure other than to support, in a general way, existing State and Federal truck and bus noise regulations.

12. Education and Complaint Mechanism applied to Garden Equipment and People

- Changes resulting from this countermeasure typically cost less money than changes caused by Countermeasure No. 1, which deals with the same noise sources but may require equipment substitution to meet the regulation. In contrast, education and complaints act to achieve nearly the same ends without large expenditures.
- Implications - To reduce noise from garden equipment and people in the most cost effective way (1) people should be educated as to the effect of their (and their equipment's) noise on others, and (2) a means of complaining about annoying neighborhood noises should be established.

To assist officials in enforcing the reduction of these "annoying noises", as a practical matter, a property standard such as Countermeasure No. 1 may be needed, but the latter should not be implemented in isolation.

14,15. Stationary Source Controls applied to Fairgrounds and Music Clubs

- No expenditures were made on these countermeasures due to their transitory and isolated nature. That is, in comparison with more continuous noise sources such as autos, their average sound levels (L_{eq}) were low. (Note, however, that noise levels for these two sources of noise were estimated without the aid of noise measurements from the acoustical survey.)
- Implications - No substantial noise control activity seems warranted for these two noise sources.

16. Building Insulation and Building Codes

- Only a small portion (5 percent) of the total possible expenditure on this countermeasure was made, since only 5 of 20 possible cells received insulation and the cells which were picked have small floor areas. However, the effort required to insulate these cells amounts to almost 60 percent of the total cost to society at the budget level considered. At lower overall budget levels, such as the more desirable budget used to generate Figure A-15, no expenditure on building insulation is made by the computer program.
- Implications - A building insulation program should be initiated only if (1) the public is willing to help pay for improvements to their own homes (note that as shown in Table A-9, the city government is expected to incur only about 4 percent of the total cost of this countermeasure) and (2) a high degree of expenditure on noise control is desired and possible. If a building insulation program is desired, the noise optimizations for 1980

and 1988 indicate that the following areas deserve initial attention:

1. Residences near Hanover Street (cells B1 and B3)
2. Residences along garbage truck routes - Bayard Street and Roth Avenue (cells R5 and R7)

Reduction of Noise Impacts Due to Expenditures

Figure A-16 shows the relationship between cost expenditure and percent reduction of the noise impact index* for the 1980 Allentown analysis. This relationship clearly indicates that after a certain point, the cost of additional benefits is much higher than before. This point corresponds to a total discounted cost to society of about 1.1 million dollars, equivalent to an expenditure of about \$100,000 annually. The associated discounted cost to the city of Allentown (from now to infinity) would be about 0.9 million dollars, or about \$82,000 annually. This represents about a 1/3 reduction of the present anticipated Allentown annual budget, indicating that in the future, a somewhat reduced budget for noise control could be acceptable from the cost effectiveness standpoint.

*The Noise Impact Index (NII) is a measure of the impact of noise on a community. A threshold of impact (NII = 0) is defined for each land use type for both day and night noise levels, and a complete impact (NII = 1.0) is defined to be 20 dB above these threshold values.

FINAL EXPENDITURES ON EACH COUNTERMEASURE
 USER (Government) COST, $U = 1.34 \cdot 10^6$ TOTAL COST, $T = 3.75 \cdot 10^6$

Total Decrease in Noise Impact Index = 5.7%

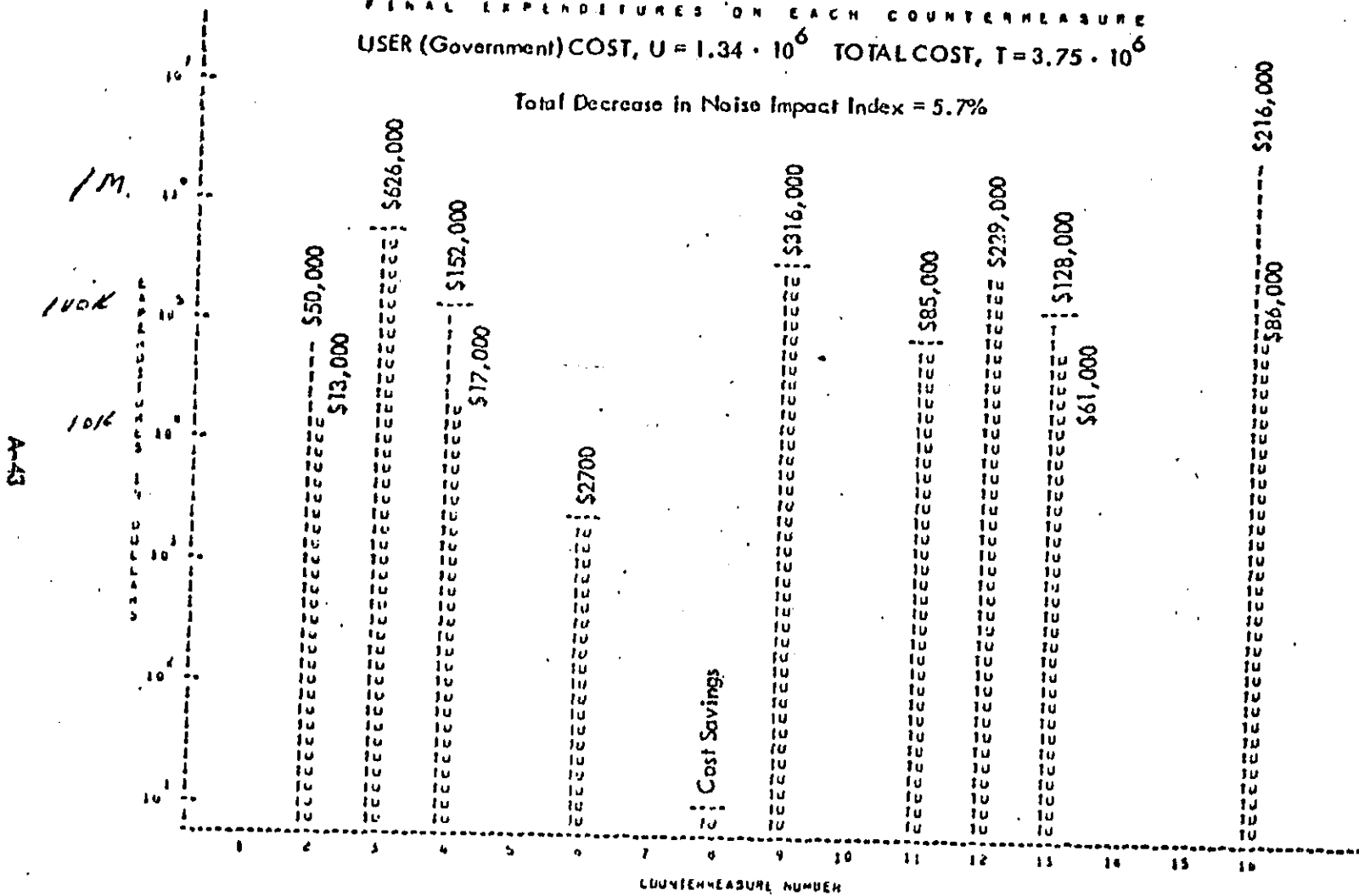

Figure A-12. Expenditures Optimized in 1980

FINAL EXPENDITURES ON EACH COUNTERMEASURE

USER (Government) COST, U = \$1.33 · 10⁶ TOTAL COST, T = \$3.75 · 10⁶

Total Decrease in Noise Impact Index = 5.8%

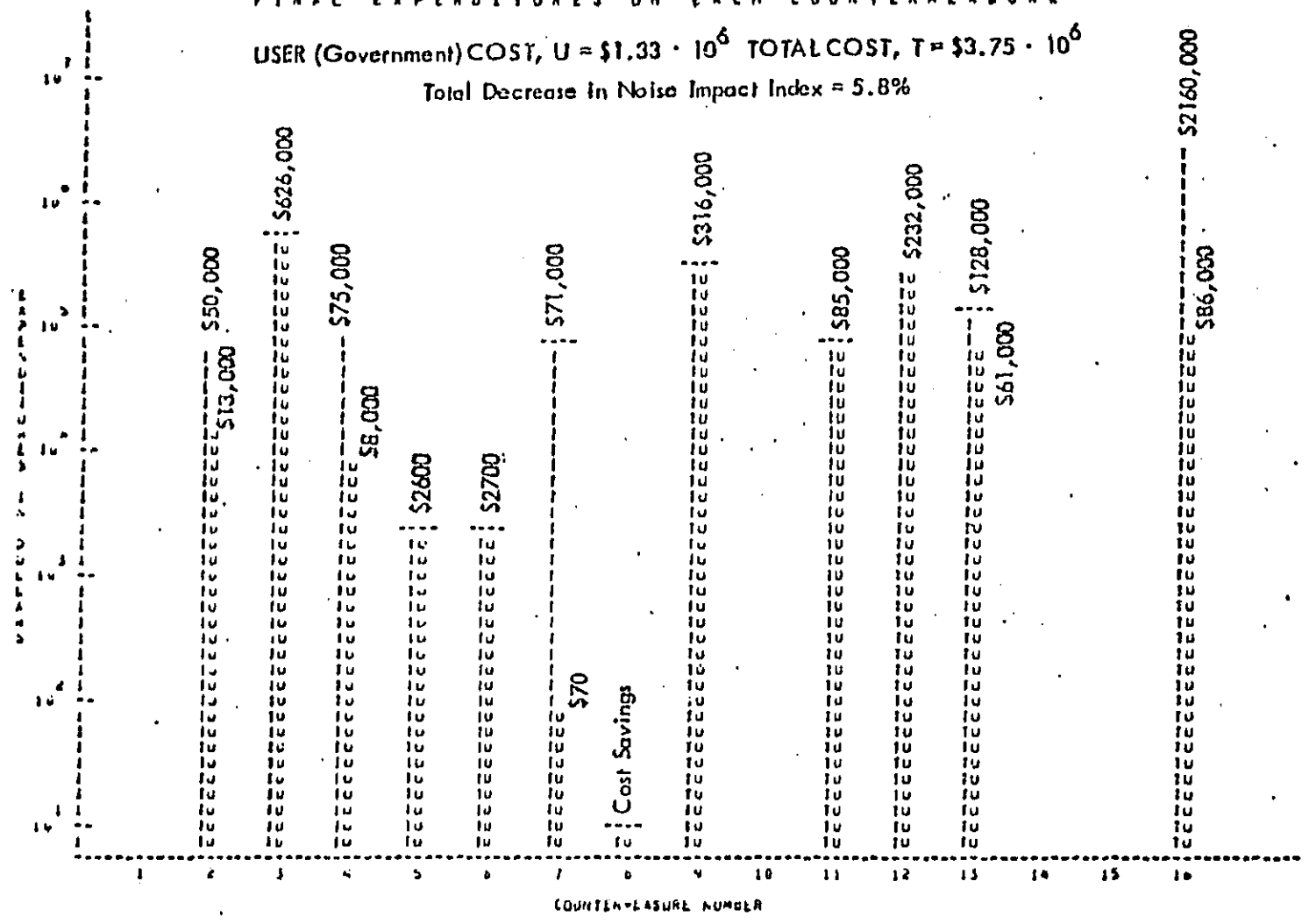

Figure A-13. Expenditures Optimized in 1988

FINAL EXPENDITURES ON EACH COUNTERMEASURE
 USER (Government) COST, $U = \$1.36 \cdot 10^6$ TOTAL COST, $T = \$1.70 \cdot 10^6$
 Total Decrease In Noise Impact Index = 5.3%

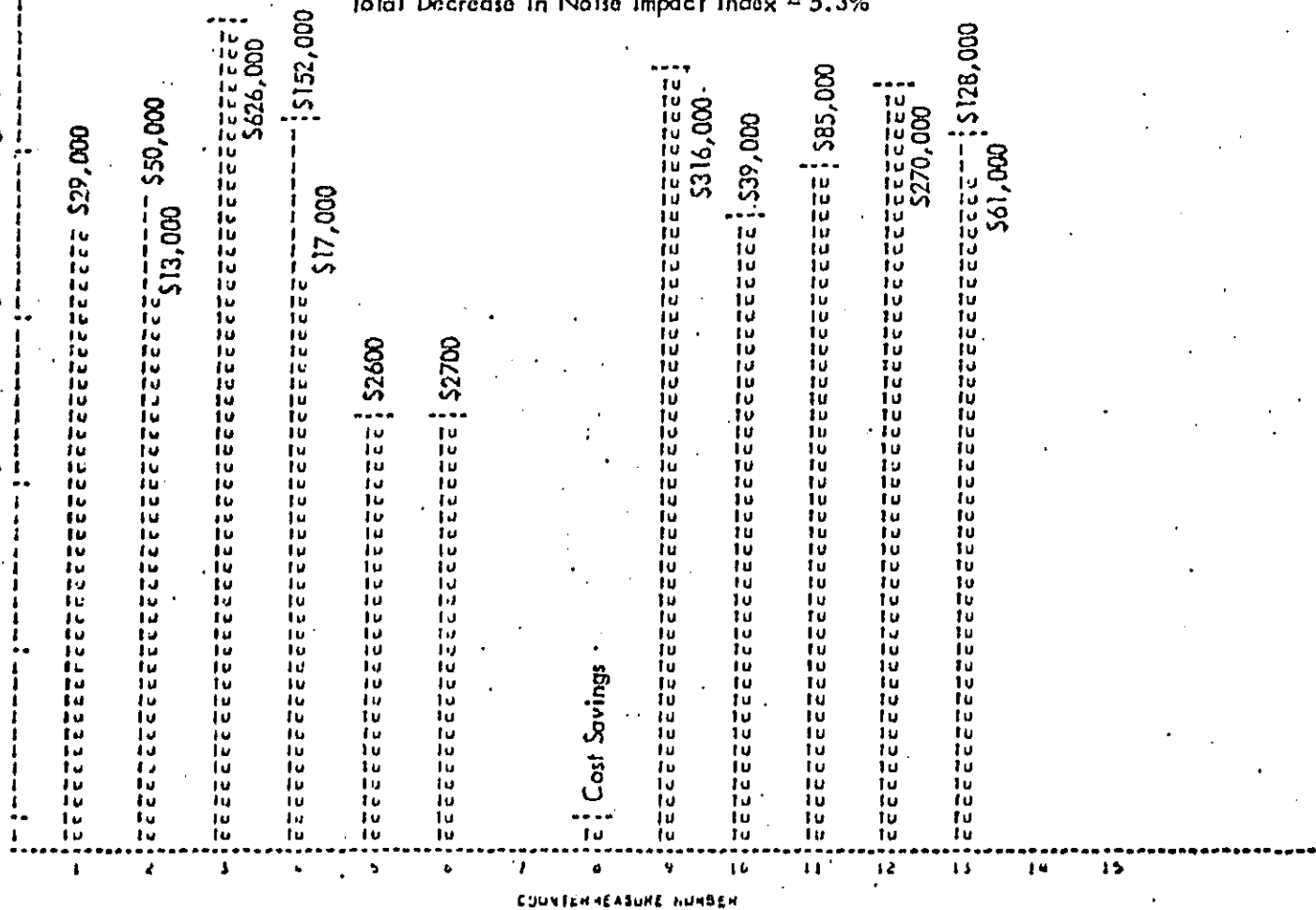

Figure A-14. No Building Insulation, Optimized in 1980

FINAL EXPENDITURES ON EACH COUNTERMEASURE
USER (Government) COST, $U = \$0.91 \cdot 10^6$ TOTAL COST, $T = \$1.10 \cdot 10^6$
Total Decrease in Noise Impact Index = 5.1%

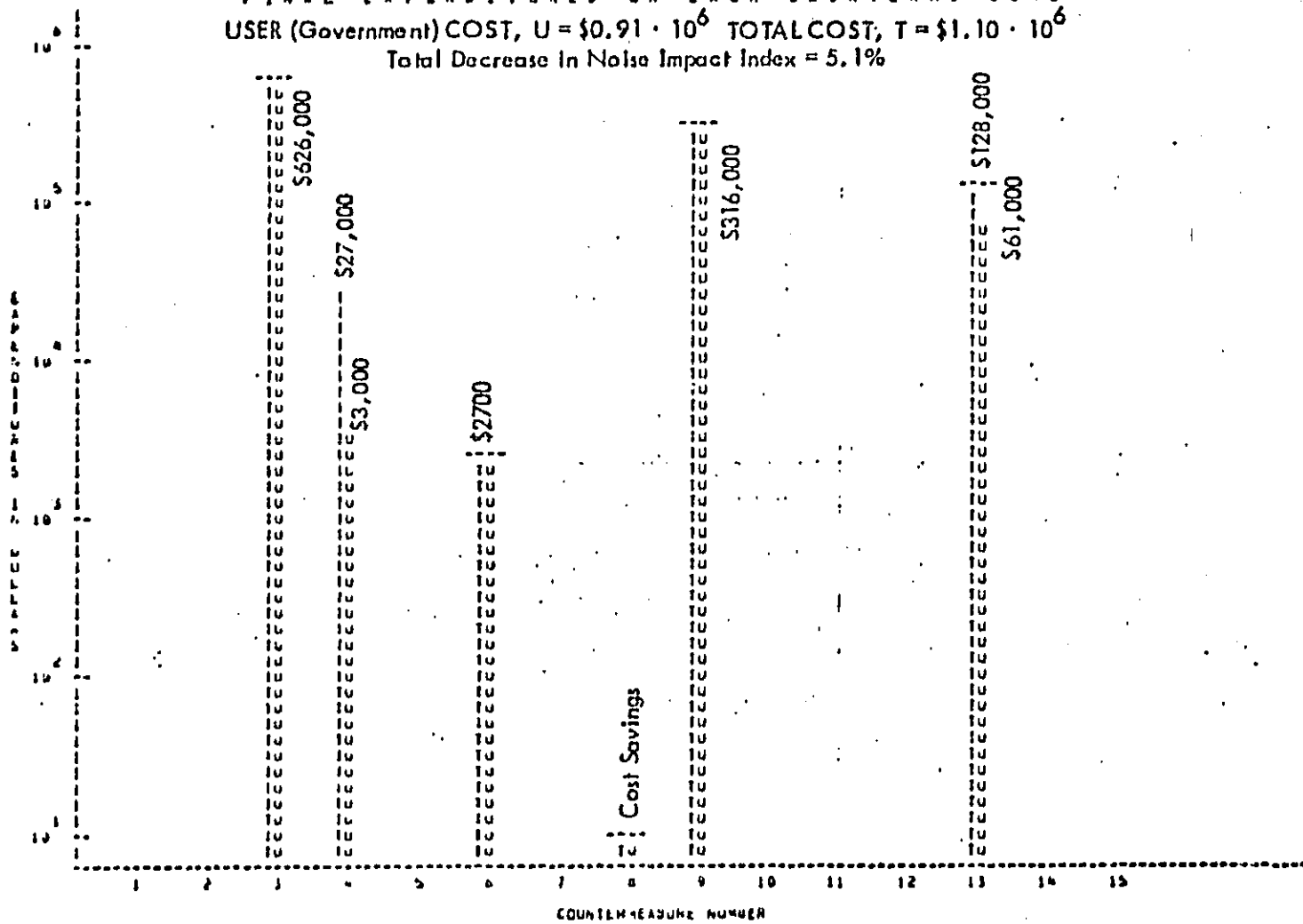

Figure A-15. Lower Budget, Optimized in 1980

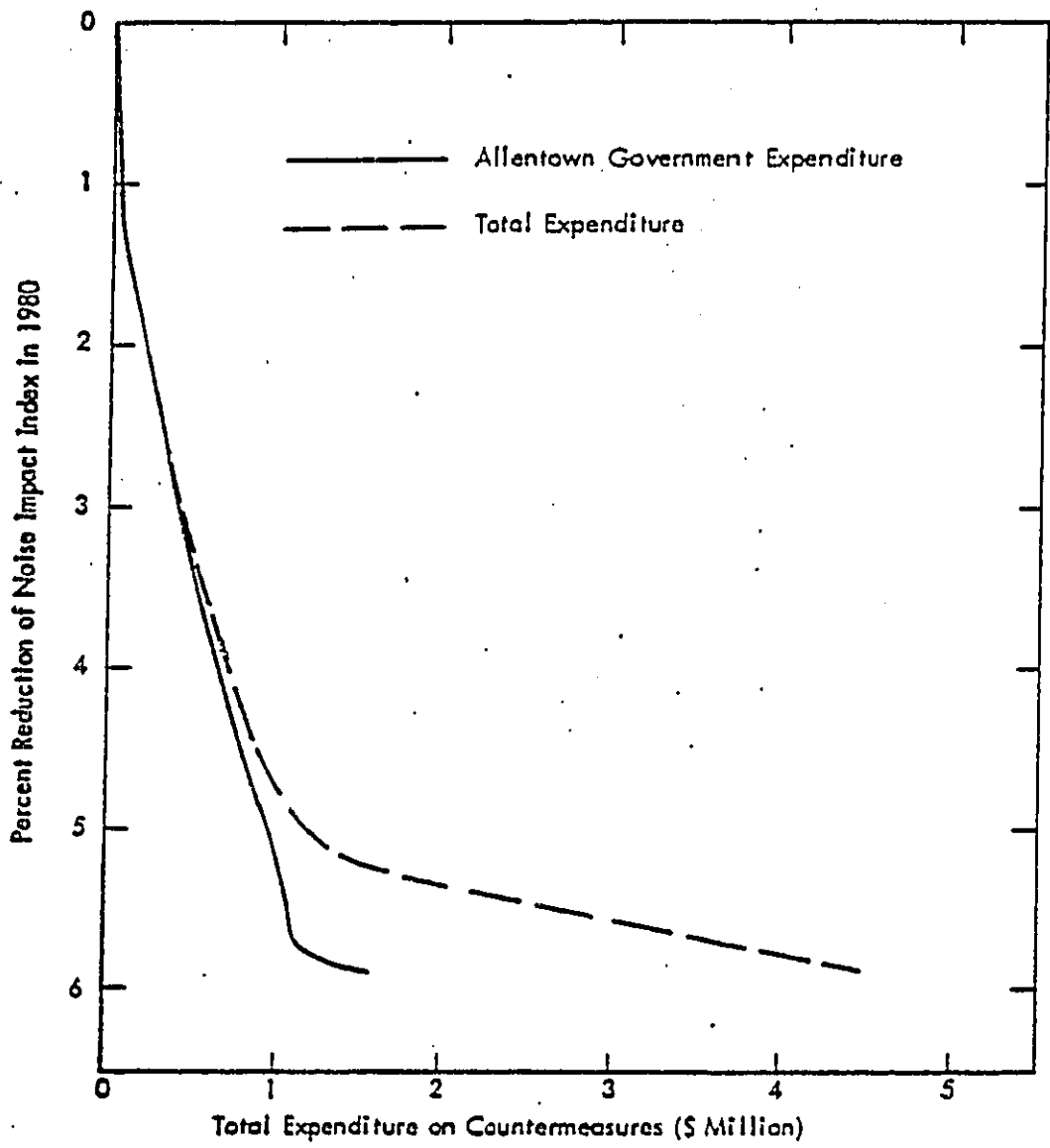

Figure A-16. Relationship Between Total Expenditures on Countermeasures and Reduction of Noise Impact Index in 1980

LIST OF TABLES

<u>Table No.</u>		<u>Page</u>
B-1	Cost/Benefit Ratios Calculated During the Stationary Source Suboptimization Process	B-9
B-2	Methods of Solution For All Meaningful Cases Which Can Arise During the Optional Expenditure of Funds on Stationary Source Countermeasures	B-12
B-3	Incremental Benefit Parameters Used In Path-Receiver Countermeasure Suboptimization	B-15
B-4	Program Techniques For Path-Receiver Countermeasures	B-17

LIST OF FIGURES

<u>Figure No.</u>		<u>Page</u>
B-1.	Subroutine Linkage Diagram Indicating Program Flow By Codeword	B-2
B-2.	Subroutine Linkages (Alphabetical Order) For the Main Optimization Process, Codeword OPT	B-3
B-3.	Operational Flow of Optimization Decision Process, Subroutine OPTIM	B-4
B-4.	Logical Operation of Subroutine XNOIM, Evaluation of Expenditure Scenarios	B-6

APPENDIX B

Program Operation and Data Flow Process

B-1 General Overview of Program Flow

It is assumed that the reader is familiar with the terms and concepts presented in Volume I - the NOIZOP User's Guide.

The initial functions of the program are to accept input data and to establish the necessary parameters for proper data processing. Figure B-1 illustrates the subprogram linkage associated with each of the program codewords. The reader may refer to Volume II - Program Listings - for a description of each subroutine. Figure B-2 shows the subroutine linkages of the actual optimization process. The remainder of this section will describe the general data flow during that optimization process. The succeeding sections in this appendix will describe in more detail the individual processes that occur. The variables in the equations presented in this appendix do not necessarily relate to actual variable names used in the program.

The optimization process is controlled by a supervisory subroutine (OPTIM) which examines the components of the NII (Noise Impact Index) gradient vector* in determining the path of optimum expenditure allocation among the countermeasures. Starting with the user-defined initial expenditure scenario, the program will compute the current NII and the current gradient vector. The largest component of the gradient vector indicates the countermeasure which is currently the most cost-effective. The program will allocate additional funds to that countermeasure and calculate the resultant NII and the new gradient vector. This process is repeated, increasing the expenditures among the countermeasures one at a time, until the total budget has been expended.

Generally, subroutine OPTIM controls the evaluation of independent expenditure scenarios. The remainder of the program simply calculates the Noise Impact Index and the gradient values according to the expenditures on each of the countermeasures. After OPTIM has decided on a new set of expenditures, the remainder of the program is entered again to evaluate the new scenario, unaware of any information regarding the previous set of expenditures. Figure B-3 illustrates the main features of the optimization decision process.

*Mathematically, the gradient vector may be thought of as the vector whose components consist of the partial derivatives of NII with respect to the countermeasure expenditures, of which there may be up to 20.

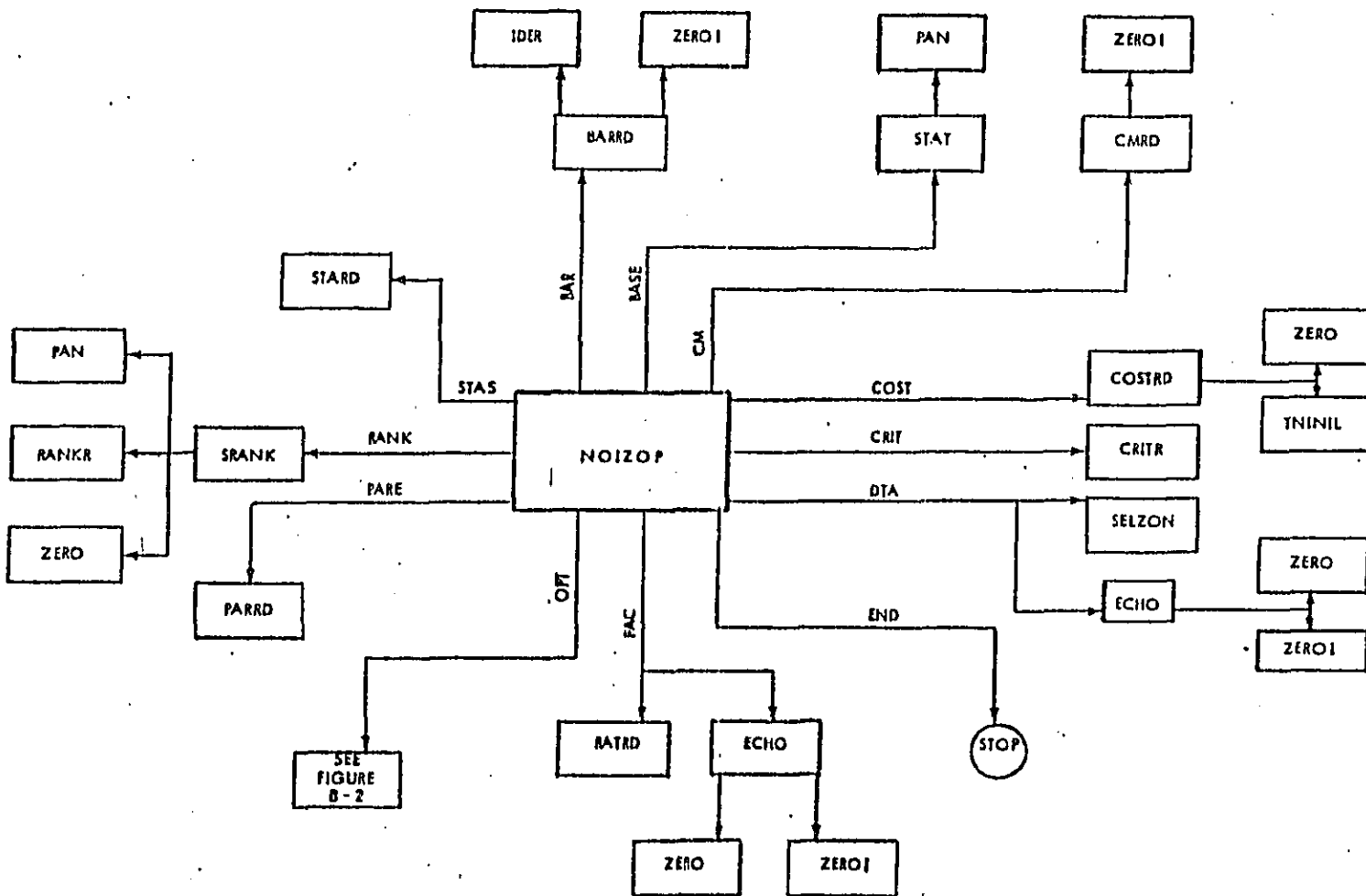

Figure B-1. Subroutine Linkage Diagram Indicating Program Flow By Codeword

B-2

DEPT. OF THE ARMY

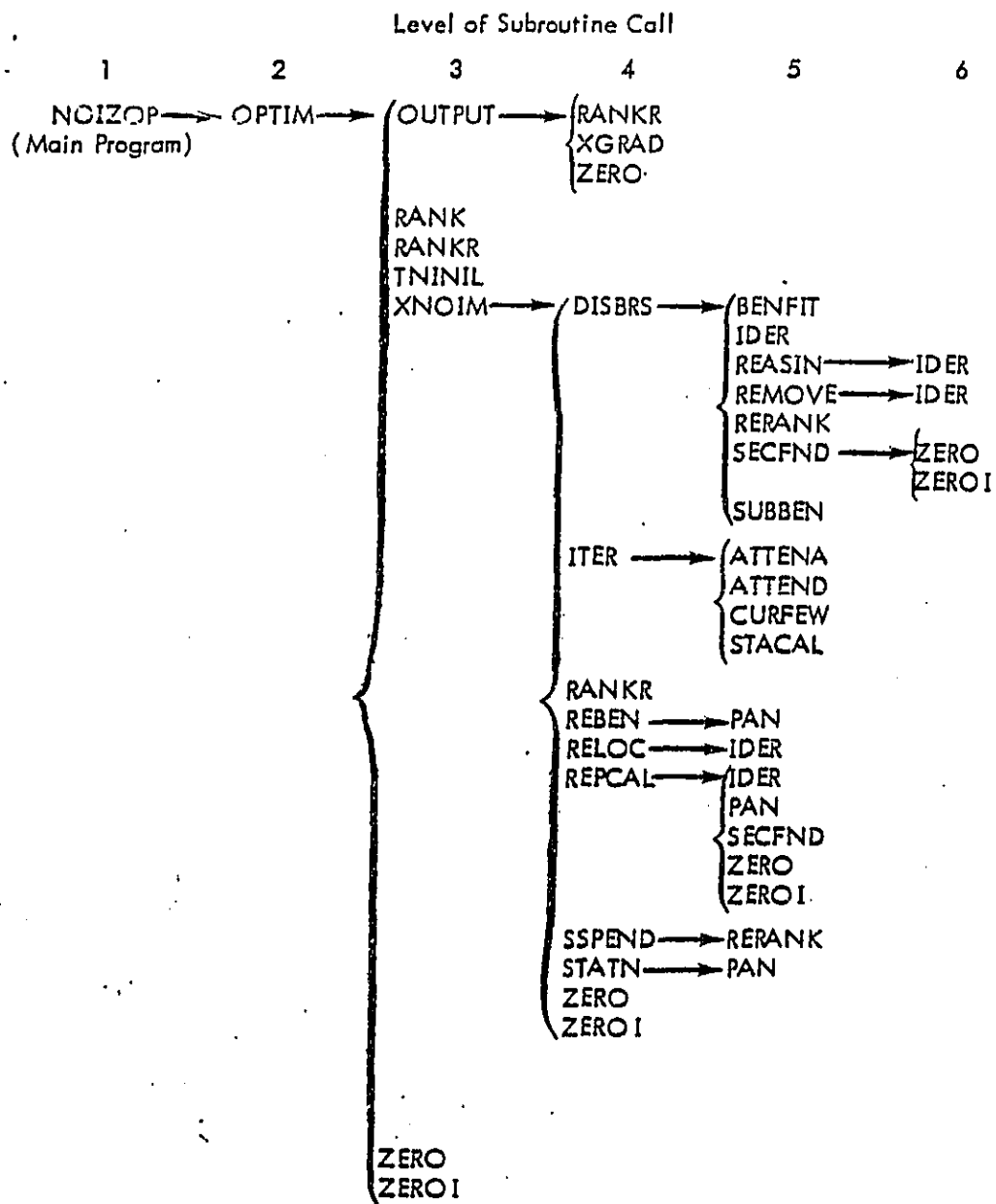

Figure B-2. Subroutine Linkages (Alphabetical Order) For the Main Optimization Process, Codeword OPT.

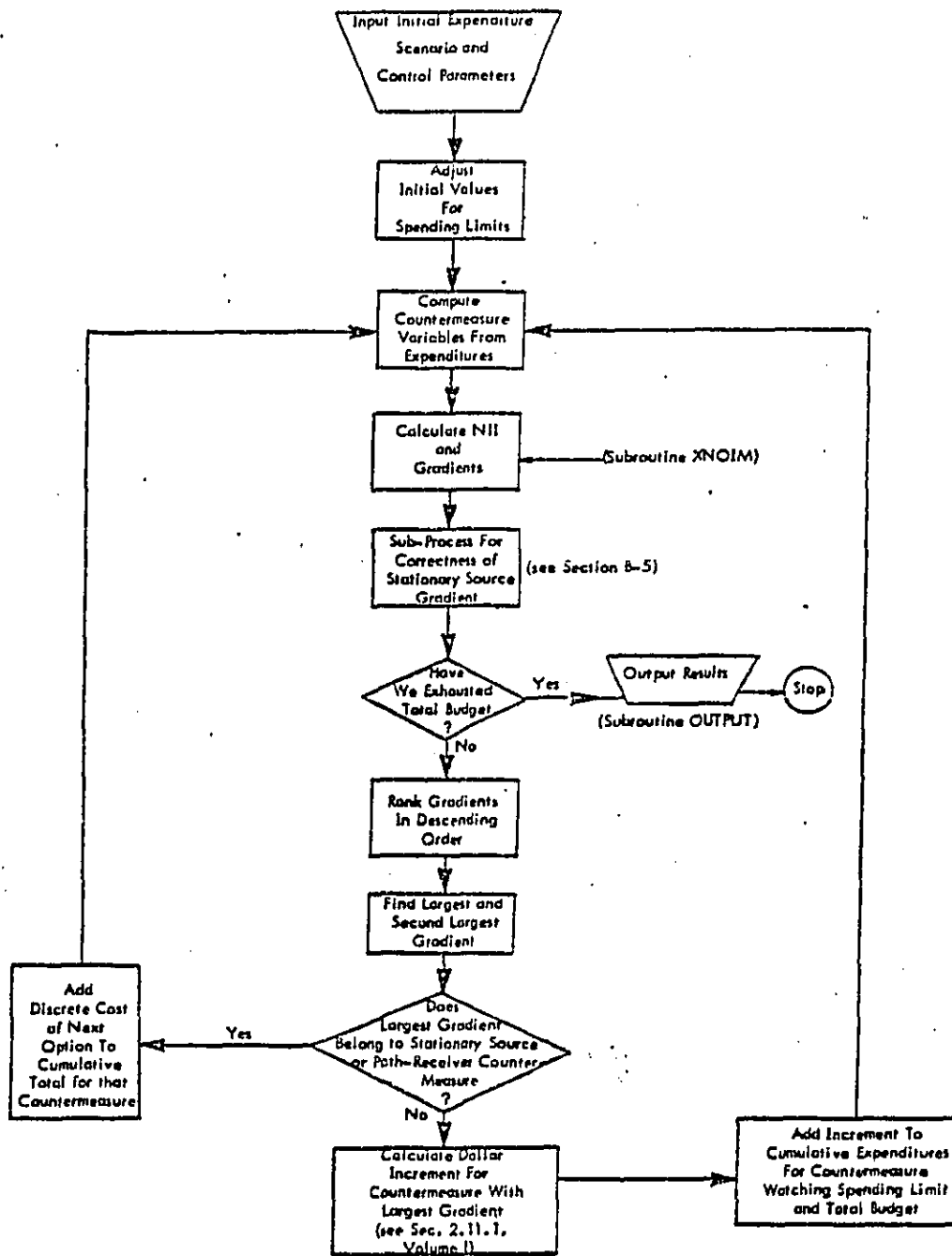

Figure B-3. Operational Flow of Optimization Decision Process, Subroutine OPTIM.

The index and gradient calculation process is controlled by a secondary level subroutine - XNOIM. This routine controls the logic of all subsequent functions including the suboptimization of stationary source and path-receiver countermeasures (see Sections B-2, B-3).

XNOIM initiates three independent passes of countermeasure application through all the cells. The first pass through the cells is used in the suboptimization of the stationary source countermeasure. Countermeasure Types 1-15 are applied on a cell-by-cell basis and the remaining noise exposure is used in the evaluation of the potential benefits of each of the stationary source countermeasure options utilizing an approximation of path-receiver benefits (see Section B-3).

The second pass through the cells is used in the suboptimization of the path-receiver countermeasure. The other countermeasures are again applied and, together with the results from the first pass (stationary source suboptimization), the potential benefits of each path-receiver option are calculated.

The third pass again applies countermeasure Types 1-15 along with the optimized results for stationary source and path-receiver countermeasures obtained in the first two passes. This pass through the cells calculates the components of the gradient vector and the Noise Impact Index. Figure B-4 shows the logical operation of subroutine XNOIM.

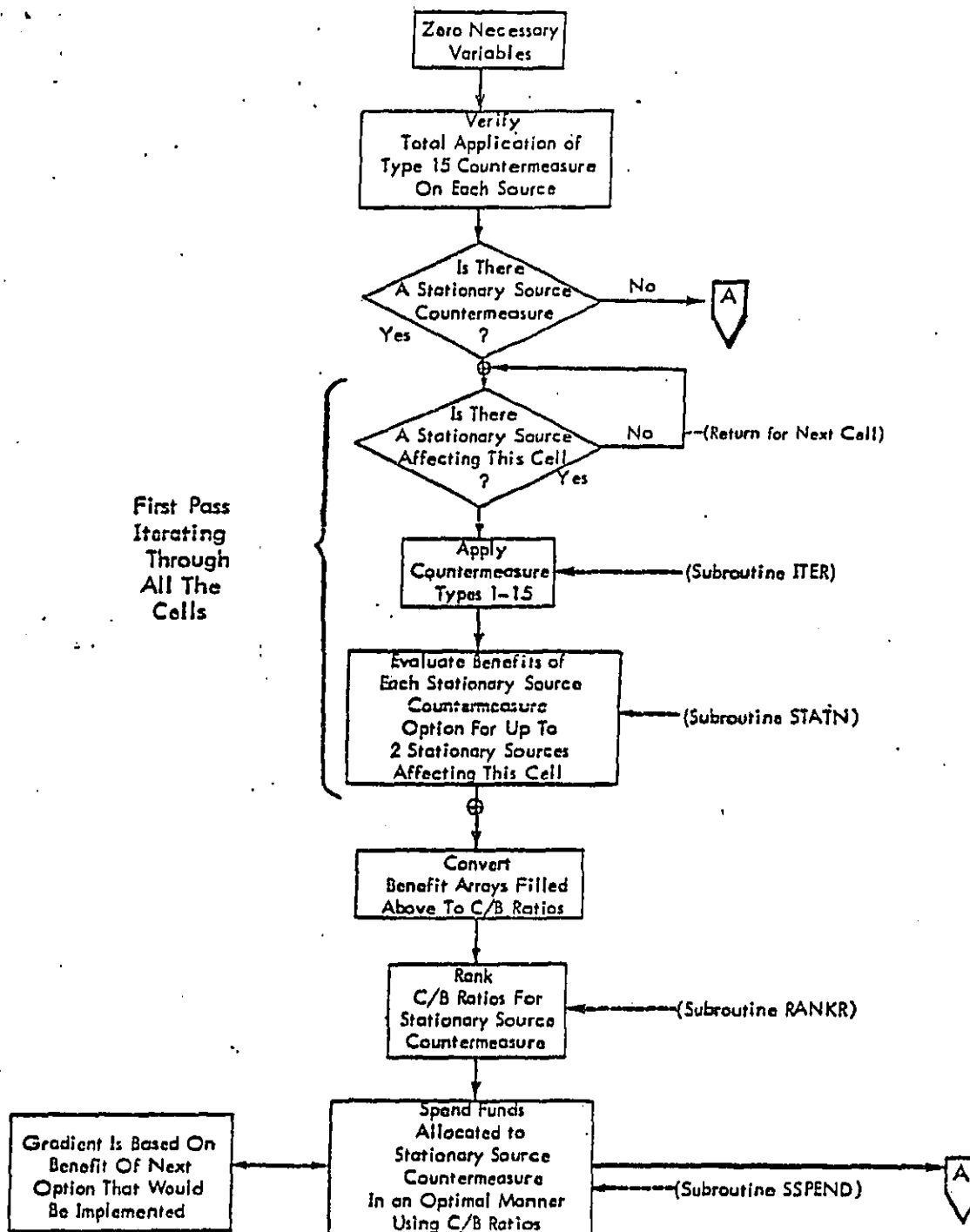

Figure B-4. Logical Operation of Subroutine XNOIM, Evaluation of Expenditure Scenarios. (C/B = Cost/Benefit)

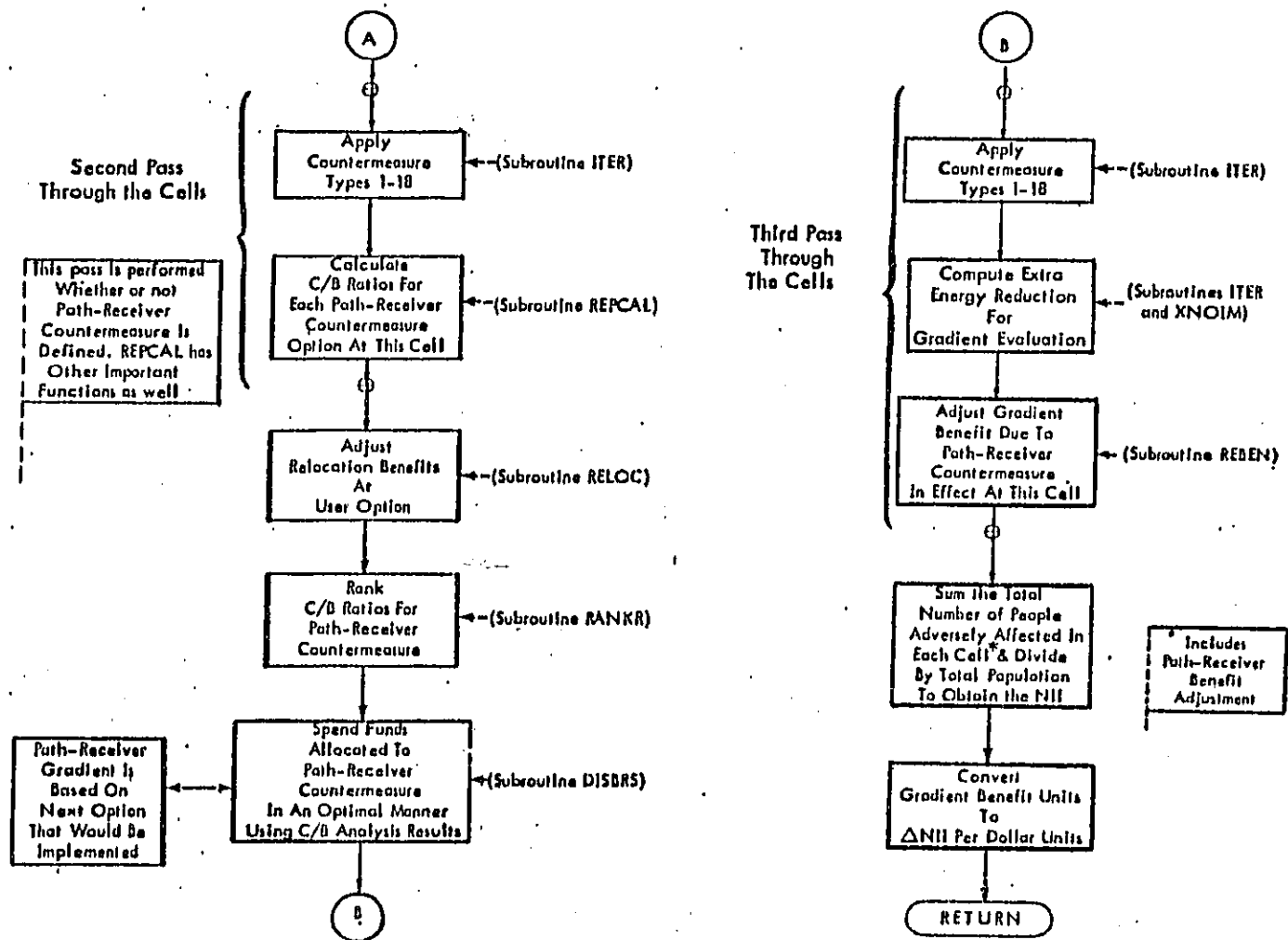

Figure B-4 (Continued)

B-2 Suboptimization of Stationary Source Countermeasures

The stationary source countermeasure lists six alternative options (see Table 2-3, Volume I) which may be implemented at each stationary source. The program will decide which option, if any, to apply to each stationary source. The actual procedure involved in this decision is described in this section.

The basis of the suboptimization process is a cost/benefit analysis which consists of computing the potential benefit of each alternative option at each source together with the associated costs. The end product of this analysis is an ordered list of cost/benefit ratios, the most cost-effective options being at the top of the list. The program will proceed to implement the countermeasure alternatives, starting at the top of the list, until the funds allocated to the stationary source countermeasure are exhausted. Note that the allocated funds may be zero, in which case no alternatives are implemented and the generated list is used only for gradient evaluation. (Section B-5). Note also that after this suboptimization some stationary sources may have countermeasures applied to them and some may not.

One segment of the cost/benefit analysis calculates the potential benefit of each countermeasure alternative at each stationary source. The benefit parameter is the number of people no longer adversely affected by noise with the implementation of that option. Note that this parameter is summed over all cells that are affected by the stationary source in question. Before the benefit parameters can be accurately evaluated, the effects of the other countermeasure types (Types 1 through 15) must be known. These other countermeasures have been applied by the time the program considers the stationary source countermeasure. The path-receiver alternative which was selected for each cell for the expenditure scenario calculated during the previous step in the optimization analysis is also assumed to apply again. This is equivalent to performing the first two steps of the iterative process which is required to simultaneously optimize the two interrelated subjects. This procedure is necessary because the transfer function may not be linear in all defined regions and the potential benefit must be limited by the actual number of people that are still adversely affected after the implementation of the other countermeasure types.

In actuality, cost/benefit ratios for eight countermeasure alternatives are calculated as shown in Table B-1 below. Note that the first four coincide with the first four options in Table 2-3, Volume I.

Table B-1
 Cost/Benefit Ratios Calculated During the
 Stationary Source Suboptimization Process

Benefit Parameter	Countermeasure Alternative
1	A minimum source reduction.
2	A maximum source reduction.
3	Elimination of night operations.
4	Elimination of the source.
5	Elimination of night operations if a minimum reduction was in effect.
6	Elimination of night operations if a maximum reduction was in effect.
7	A minimum reduction if night operations were eliminated.
8	A maximum reduction if night operations were eliminated.

Benefit parameters 1 and 2 are calculated by using the simple energy reduction formula

$$NL = OL \cdot 10^{\frac{-RED}{10}}$$

where

NL = Noise energy remaining after treatment,

OL = Noise energy before treatment,

RED = Decibel reduction from the treatment.

The transfer function is entered using OL and NL, and, together with the impacted population, the difference in adverse effect is computed. This procedure is cumulative over all cells - both day and night - affected by the particular stationary source.

Benefit parameter 3 is calculated by simply summing the remaining number of adversely affected people in each night cell affected by the source.

Item 4 is like 3, except that both day and night cells are considered.

The benefits of items 5 and 6 are computed by subtracting the benefits of items 1 and 2, respectively, from item 3. This procedure is performed only for night cells. Thus, the incremental effect of eliminating the night operations is obtained.

Parameters 7 and 8 are calculated by summing the benefits of items 1 and 2, respectively, over the day cells alone. In this manner, the incremental benefits are computed.

The benefit values are then converted to cost/benefit ratios by considering the costs associated with these measures. Costs for items 1 through 4 are input directly; costs for items 5 and 6 are the same as for item 3; and items 7 and 8 are the same as for items 1 and 2, respectively.

The cost/benefit ratios for items 1-4 are then placed in a separate list and sorted in ascending order. The most cost-effective options (those with the greatest benefit for the least cost) appear at the top of the list. Given the total expenditure allocated to the stationary source countermeasure, the next step is to spend that money in the most cost-effective manner. This is accomplished by proceeding through the list of cost/benefit ratios, beginning at the top, noting the costs of each, and noting which options, if any, have previously been applied to each source. The necessity for the latter will become apparent in the following paragraph.

Many complications can arise. For example: Suppose the next option to apply is a minimum reduction to stationary source number six, but a more cost-effective option was to eliminate the night operations of source number six. Hence, since we have already decided to eliminate the night operations of that source, the cost/benefit ratio previously calculated for a minimum reduction is not correct. The program method is to replace the ratio for the minimum reduction alone with the cost/benefit ratio for a minimum reduction with night operations eliminated - alternative number seven in Table B-1. This ratio can now be used since it is known that the night operations have been eliminated. The correct ratio is inserted and the remainder of the ordered list of cost/benefit ratios (including the inserted ratio) is reranked to verify that the inserted ratio is still the next most cost-effective option to implement (i.e., has not moved down the list). If it is, then the option applied to stationary source number six would be identified as number five in Table 2-3, Volume I - a combination of two independent countermeasures, elimination of night operations and minimum reduction. These complications are the reason for the calculation of cost/benefit ratios numbers 5 through 8 listed in Table B-1.

Not all complications are as easily handled as just described. Table B-2 summarizes the methods for resolving all complications that can arise. Note that these complications are due to the implementation of multiple options on one stationary source. Before any option is implemented, the program will check which options, if any, have previously been applied to the source.

The final result of the suboptimization process is a list of option numbers as shown in Table 2-3, Volume I, each of which correspond to a defined stationary source. The actual application of the selected countermeasure option for each source, where the decibel reduction is finally registered, takes place after this list has been compiled (Section B-4).

Table B-2

Methods of Solution For All Meaningful Cases Which Can Arise During the
Optional Expenditure of Funds On Stationary Source Countermeasures

(underscored numbers correspond to option numbers described in Table 2-3, Vol. 1)

Previous Option Applied To This Source	Allowed Additional Options and Method For Evaluating Potential Benefit
<u>0</u> (nothing)	<u>1-4</u> No modification to straightforward procedure.
<u>1</u>	<p><u>2</u> Recompute cost/benefit (S/B) ratio according to</p> $C/B = \frac{\$ \text{max. red.} - \$ \text{min. red.}}{B \text{max. red.} - B \text{min. red.}}$ <p>where the individual costs and benefits are extracted from the individual cost/benefit ratios.</p> <p><u>3</u> Use cost/benefit ratio number 5 in Table B-1</p> <p><u>4</u> Recompute cost/benefit ratio according to</p> $C/B = \frac{\$ \text{elim. source} - \$ \text{min. red.}}{B \text{elim. source} - B \text{min. red.}}$
<u>2</u>	<p><u>3</u> Use cost/benefit ratio number 6 in Table B-1</p> <p><u>4</u> $C/B = \frac{\\$ \text{elim. source} - \\$ \text{max. red.}}{B \text{elim. source} - B \text{max. red.}}$</p>
<u>3</u>	<p><u>1</u> Use cost/benefit ratio number 7 in Table B-1</p> <p><u>2</u> Use cost/benefit ratio number 8 in Table B-1</p> <p><u>4</u> $C/B = \frac{\\$ \text{elim. source} - \\$ \text{elim. night}}{B \text{elim. source} - B \text{elim. night}}$</p>
<u>4</u>	NOTHING
<u>5</u>	<p><u>2</u> Subscript numbers refer to C/B ratios in Table B-1</p> $C/B = \frac{\$ \text{max. red.} - \$ \text{min. red.}}{B_8 - B_7}$ <p><u>4</u> $C/B = \frac{\\$ \text{elim. source} - (\\$ \text{elim. night} + \\$ \text{min. red.})}{B_4 - (B_5 + B_1)}$</p>
<u>6</u>	<u>4</u> $C/B = \frac{\$ \text{elim. source} - (\$ \text{elim. night} + \$ \text{max. red.})}{B_4 - (B_6 + B_2)}$

B-3 Suboptimization of Path-Receiver Countermeasures

The suboptimization of the path-receiver countermeasure options (see Table 2-4, Volume I) proceeds much in the same manner as for the stationary source countermeasure. However, since there are more alternatives, and there exists the concept of secondary cells for barriers, the procedure is much more complicated.

The initial step is the calculation of benefit parameters and cost/benefit (C/B) ratios for each alternative at each cell. Unlike stationary sources, the benefit parameters are saved in addition to the resulting C/B ratios. The benefits are in units of people no longer adversely affected. In addition, the benefits are evaluated with the other countermeasure types in effect, including the result of the optimized stationary source countermeasure.

Eighteen benefit parameters are calculated for each cell. In addition, the first six are used in the calculation of C/B ratios for rank ordering before the actual selection process begins.

1. Minimum soundproofing is applied in a straightforward manner to all cells using the following energy reduction formula:

$$NL = OL \cdot \left[T + (1 - T) \cdot 10^{\frac{-RED}{10}} \right]$$

where

NL = Resulting energy level,

OL = Energy level before soundproofing,

T = Fraction of time spent outdoors (i.e., when soundproofing is effective, this value is dependent on land use type and on day and night),

RED = Decibel reduction from the soundproofing; this value is also dependent on land use type.

The resulting energy level is then entered into the transfer function and compared to the transfer function result using the unattenuated level. The difference is the benefit of the soundproofing in terms of people no longer adversely affected. The cost of soundproofing a

cell is obtained by multiplying the area for soundproofing in square feet (input in the master data set) by the cost per square foot for this grade of soundproofing at this type of cell (residential or commercial). The benefit parameter is summed over the day and the night version of this cell.

2. Medium soundproofing is similar to minimum soundproofing.
3. Maximum soundproofing is also similar to minimum soundproofing.
4. Low barriers require more complex handling due to the fact that one primary cell and up to three secondary cells may be affected. Barrier attenuation is computed using the following formula:

$$RE = SL \cdot \left(10^{\frac{-ATT \cdot ER}{10}} \right)$$

where

- RE = Remainder of the noise energy after erection of the barrier,
- SL = Noise energy from the noise source being attenuated,
- ATT = Decibel attenuation of the barrier on a standard source (see Section 2.4, Vol. I),
- ER = Effectiveness ratio for the current noise source.

The above formula is applied to each source level individually; the results are then summed to obtain the total remaining noise energy.

For the purposes of preparing C/B ratios, all benefits of a barrier at the secondary cell location are combined with the benefits at the primary cell location. A barrier location is always identified by the primary cell associated with that barrier. The individual barrier benefits at every cell location affected by a barrier are, in addition, stored separately for later use. As always, benefits are in terms of people no longer adversely affected.

5. High barriers are handled in the same way as are low barriers. Note that the secondary cells for a high barrier may be different from the secondary cells for the associated low barrier. Since the program can allow only one barrier to affect

a cell, and since a secondary cell may be affected by more than one barrier location, the program will select the barrier location which is the most effective at each cell. This selection is repeated independently for each barrier height. Consequently, the program may select a different barrier location for the low barrier as for the high barrier as far as one particular cell is concerned.

6. Relocation can be treated two ways at the user's option (see Section 2.5, Vol. I). The benefits are either corrected for the region into which people would be moved, or uncorrected. In the latter case, the benefit is all the people in the cell who are adversely affected. All cell locations may be subject to relocation.

The parameters listed in Table B-3 are not used in the calculation of cost/benefit ratios but are used in the event that more than one of the above countermeasure alternatives are to be applied to the same cell location.

Table B-3
Incremental Benefit Parameters Used In
Path-Receiver Countermeasure Suboptimization

Incremental Benefit Parameter Number	Incremental Benefit Parameter
7	Minimum soundproofing if low barrier in place.
8	Medium soundproofing if low barrier in place.
9	Maximum soundproofing if low barrier in place.
10	Minimum soundproofing if high barrier in place.
11	Medium soundproofing if high barrier in place.
12	Maximum soundproofing if high barrier in place.
13	Low barrier if minimum soundproofing in place.
14	Low barrier if medium soundproofing in place.
15	Low Barrier if maximum soundproofing in place.
16	High barrier if minimum soundproofing in place.
17	High barrier if medium soundproofing in place.
18	High barrier if maximum soundproofing in place.

Table B-4 summarizes the situations that can arise when combinatorial or replacement countermeasure alternatives are applied to the same cell. An example of a replacement is the application of a higher grade of soundproofing at a cell where a lower grade was implemented previously.

Table B-4

Program Techniques For Path-Receiver Countermeasures
(underscored numbers refer to countermeasure options as listed in Table 2-4, Vol. 1)

Previous Option Applied To This Cell	Allowed Additional Options and Method For Evaluating Potential Benefit
<u>0</u> (nothing)	<p><u>1-6</u> Straightforward Procedure (note that 4 and 5 will only occur for the primary cell of a barrier, in which case we must check those options already implemented at the secondary cell locations and adjust the cost/benefit ratio accordingly before performing the reranking operation which verifies that the adjusted cost/benefit ratio is still the most cost-effective).</p> <ol style="list-style-type: none"> 1. Indicate that the option is implemented at the cell(s) in question. 2. Register the cost of the option. 3. Save benefit achieved for each affected cell. <p>The following cases all require the above as a minimum. The descriptions will refer to the procedure that must be followed before the above three steps are implemented.</p>
<u>1</u>	<p><u>2</u> Recompute the cost/benefit (C/B) according to</p> $C/B = \frac{\$_{med.sprf.} - \$_{min.sprf.}}{B_{med.sprf.} - B_{min.sprf.}}$ <p><u>3</u> $C/B = \frac{\\$_{max.sprf.} - \\$_{min.sprf.}}{B_{max.sprf.} - B_{min.sprf.}}$</p> <p><u>4</u> This will occur for primary cells only. Determine what has been done to each secondary cell (must be soundproofing, relocation, or nothing in this specific case). Use the appropriate incremental benefit parameters (7-18) in Table B-3 (zero benefit if relocation) to determine the total benefit at the secondary cell (sc) locations of building this barrier at the primary cell. Add that total to parameter no. 13 for the primary cell to obtain total benefit.</p> $C/B = \frac{\$_{low bar.}}{B_{13} + \sum_{sc} \Delta B_{low bar.}}$ <p>where ΔB is used to signify appropriate incremental benefit parameter, determined by entering this table independently for each secondary cell.</p> <p><u>5</u> $C/B = \frac{\\$_{high bar.}}{B_{16} + \sum_{sc} \Delta B_{high bar.}}$</p> <p><u>6</u> $C/B = \frac{\\$_{reloc.} - \\$_{min.sprf.}}{B_{reloc.} - B_{min.sprf.}}$</p> <p>If this option is implemented, the cost of soundproofing is added back to the available total.</p>

BEST COPY AVAILABLE

Table B-4 - Continued

(underscored numbers refer to countermeasure options as listed in Table 2-4, Vol. 1)

Previous Option Applied To This Cell	Allowed Additional Options and Method For Evaluating Potential Benefit
<u>2</u>	<u>3</u> $C/B = \frac{\$_{\text{max.sprf.}} - \$_{\text{med.sprf.}}}{B_{\text{max.sprf.}} - B_{\text{med.sprf.}}}$
	<u>4</u> $C/B = \frac{\$_{\text{low bar.}}}{B_{14} + \sum_{sc} \Delta B_{\text{low bar.}}}$
	<u>5</u> $C/B = \frac{\$_{\text{high bar.}}}{B_{17} + \sum_{sc} \Delta B_{\text{high bar.}}}$
	<u>6</u> $C/B = \frac{\$_{\text{reloc.}} - \$_{\text{med.sprf.}}}{B_{\text{reloc.}} - B_{\text{med.sprf.}}}$
<u>3</u>	<u>4</u> $C/B = \frac{\$_{\text{low bar.}}}{B_{15} + \sum_{sc} \Delta B_{\text{low bar.}}}$
	<u>5</u> $C/B = \frac{\$_{\text{high bar.}}}{B_{18} + \sum_{sc} \Delta B_{\text{high bar.}}}$
	<u>6</u> $C/B = \frac{\$_{\text{reloc.}} - \$_{\text{max.sprf.}}}{B_{\text{reloc.}} - B_{\text{max.sprf.}}}$
<u>4</u>	<u>1</u> Subscript numbers refer to incremental benefit parameters in Table B-3 $C/B = \frac{\$_{\text{min. sprf.}}}{B_7}$
	<u>2</u> $C/B = \frac{\$_{\text{med. sprf.}}}{B_8}$
	<u>3</u> $C/B = \frac{\$_{\text{max. sprf.}}}{B_9}$
	<u>5</u> $C/B = \frac{\$_{\text{high bar.}} - \$_{\text{low bar.}}}{B_{\text{high bar.}} - B_{\text{low bar.}} + \sum_{sc} \Delta B_{\text{high bar.}}}$ The incremental benefit at the secondary cells is dependent on options previously implemented there.
	<u>6</u> Relocation of a primary cell removes the barrier and, thus, the benefit of the barrier on every affected cell. If the current cell is itself secondary, the summation term is not used and cost of the barrier is zero. $C/B = \frac{\$_{\text{reloc.}} - \$_{\text{low bar.}}}{B_{\text{reloc.}} - B_{\text{low bar.}} - \sum_{sc} \Delta B_{\text{low bar.}}}$

BEST COPY AVAILABLE

Table B-4 - Continued

(underscored numbers refer to countermeasure options as listed in Table 2-4, Vol. 1)

Previous Option Applied To This Cell	Allowed Additional Options and Method For Evaluating Potential Benefit	
<u>5</u>	<u>1</u>	$C/B = \frac{\$ \text{min. sprf.}}{B_{10}}$
	<u>2</u>	$C/B = \frac{\$ \text{med. sprf.}}{B_{11}}$
	<u>3</u>	$C/B = \frac{\$ \text{max. sprf.}}{B_{12}}$
	<u>6</u>	$C/B = \frac{\$ \text{reloc.} - \$ \text{high bar.}}{B_{\text{reloc.}} - B_{\text{high bar.}} - \sum_{sc} \Delta B_{\text{high bar.}}}$
<u>6</u>	NOTHING	
<u>7</u>	<u>2</u>	$C/B = \frac{\$ \text{med. sprf.} - \$ \text{min. sprf.}}{B_8 - B_7}$
	<u>3</u>	$C/B = \frac{\$ \text{max. sprf.} - \$ \text{min. sprf.}}{B_9 - B_7}$
	<u>5</u>	$C/B = \frac{\$ \text{high bar.} - \$ \text{low bar.}}{B_{16} - B_{13} + \sum_{sc} \Delta B_{\text{high bar.}}}$
	<u>6</u>	$C/B = \frac{\$ \text{reloc.} - (\$ \text{low bar.} + \$ \text{min. sprf.})}{B_{\text{reloc.}} - B_7 - B_{\text{low bar.}} - \sum_{sc} \Delta B_{\text{reloc.}}}$ <p>The incremental benefit of relocation at the secondary calls is dependent upon any soundproofing that may be there (we know the low barrier exists).</p>
<u>8</u>	<u>3</u>	$C/B = \frac{\$ \text{max. sprf.} - \$ \text{med. sprf.}}{B_9 - B_8}$
	<u>5</u>	$C/B = \frac{\$ \text{high bar.} - \$ \text{low bar.}}{B_{17} - B_{14} + \sum_{sc} \Delta B_{\text{high bar.}}}$
	<u>6</u>	$C/B = \frac{\$ \text{reloc.} - (\$ \text{low bar.} + \$ \text{med. sprf.})}{B_{\text{reloc.}} - B_8 - B_{\text{low bar.}} - \sum_{sc} \Delta B_{\text{reloc.}}}$
<u>9</u>	<u>5</u>	$C/B = \frac{\$ \text{high bar.} - \$ \text{low bar.}}{B_{18} - B_{15} + \sum_{sc} \Delta B_{\text{high bar.}}}$
	<u>6</u>	$C/B = \frac{\$ \text{reloc.} - (\$ \text{low bar.} + \$ \text{max. sprf.})}{B_{\text{reloc.}} - B_9 - B_{\text{low bar.}} - \sum_{sc} \Delta B_{\text{reloc.}}}$

Table B-4 - Continued

(underscored numbers refer to countermeasure options as listed in Table 2-4, Vol. 1)

Previous Option Applied To This Cell	Allowed Additional Options and Method For Evaluating Potential Benefit	
<u>10</u>	<u>2</u>	$C/B = \frac{\$ \text{ med. sprf.} - \$ \text{ min. sprf.}}{B_{11} - B_{10}}$
	<u>3</u>	$C/B = \frac{\$ \text{ max. sprf.} - \$ \text{ min. sprf.}}{B_{12} - B_{10}}$
	<u>6</u>	$C/B = \frac{\$ \text{ reloc.} - (\$ \text{ min. sprf.} + \$ \text{ high sprf.})}{B_{\text{reloc.}} - B_{10} - B_{\text{high bar.}} - \frac{\sum \Delta B}{ic} \text{ reloc.}}$
<u>11</u>	<u>3</u>	$C/B = \frac{\$ \text{ max. sprf.} - \$ \text{ med. sprf.}}{B_{12} - B_{11}}$
	<u>6</u>	$C/B = \frac{\$ \text{ reloc.} - (\$ \text{ med. sprf.} + \$ \text{ high bar.})}{B_{\text{reloc.}} - B_{11} - B_{\text{high bar.}} - \frac{\sum \Delta B}{ic} \text{ reloc.}}$
<u>12</u>	<u>6</u>	$C/B = \frac{\$ \text{ reloc.} - (\$ \text{ max. sprf.} + \$ \text{ high bar.})}{B_{\text{reloc.}} - B_{12} - B_{\text{high bar.}} - \frac{\sum \Delta B}{ic} \text{ reloc.}}$

B-4 Application of Countermeasures

Countermeasure Types 1 through 15 apply to moving noise sources, usually emitted from surface or air transportation vehicles. A Type 18 countermeasure is applied to stationary sources. A variety of countermeasure types were developed to deal with these noise sources. The algorithms used to implement these countermeasures are presented in this section. The reader is referred to Section 2.2 of Volume I for a more qualitative description of each countermeasure. Countermeasure Type 20 refers to path-receiver treatments.

Type 1 Frequency Reduction or Rerouting

$$NL_1 = OL_1 \cdot (1 - F)$$

$$NL_2 = OL_2 \cdot F$$

where

NL_1 = Resulting energy level from unrerouted position,

NL_2 = Resulting energy level from rerouted position,

OL_1 = Energy level from source to be rerouted,

OL_2 = Energy level from source if all operations were rerouted,

F = Fraction of operations to be rerouted (this is the countermeasure variable).

If the countermeasure is a simple frequency reduction, the NL_2 equation is not applicable.

Type 3 Reduction of Nighttime Operations

$$NL = OL \cdot (1 - F)$$

where

NL = Remaining energy after frequency reduction,

OL = Energy before any reduction,

F = Fraction of night operation to be curtailed (this is the countermeasure variable).

The above equation is used only on source levels affecting cells defined over the nighttime period.

Type 5 Shifting of Nighttime Activity to Day, or Daytime to Night

If the countermeasure variable specifies a shifting of nighttime activity to day, then the following expressions are used:

For daytime cells,

$$NL = OL \cdot \left(1 + \frac{R}{1-R} \cdot PT\right) \text{ for } R \neq 1$$

$$NL = OL \cdot PT \quad \text{for } R=1$$

For nighttime cells,

$$NL = OL \cdot (1 - PT)$$

If the countermeasure variable specifies a shifting of daytime activity to night, then the following expressions are used:

For daytime cells,

$$NL = OL \cdot (1 - PT)$$

For nighttime cells,

$$NL = OL \cdot \left(1 + \frac{1-R}{R} \cdot PT\right) \text{ for } R \neq 0$$

$$NL = OL \cdot PT \quad \text{for } R=0$$

where, for all equations

NL = Resulting energy after transfer,

OL = Energy before transfer,

R = Fraction of noise energy during nighttime period, before countermeasure application,

PT = Fraction of noise energy to be transferred (this is the countermeasure variable).

Type 10 Fixed L_{eq} Reduction to a Portion of the Source Population

$$NL = OL \cdot \left[1 - PCNT \cdot \left(1 - 10^{\frac{-DB}{10}} \right) \right]$$

where

- NL = Resulting energy level after treatment,
- OL = Energy level before treatment,
- PCNT = Fraction of source population to be treated (this is the countermeasure variable),
- DB = Decibel reduction from the treatment.

Type 12 Overall L_{eq} Reduction

$$NL = OL \cdot 10^{\frac{-DB}{10}}$$

where

- NL = Resulting energy level,
- OL = Energy level before reduction,
- DB = Decibel reduction (this is the countermeasure variable).

Type 15 Fixed L_{eq} Reduction to an Exclusive Portion of the Source Population

Successive countermeasures of this type applying to the same source affect only that portion left untreated by any previous countermeasures of this type.

$$NL = CL - OL \cdot PCNT \cdot \left(1 + 10^{\frac{-DB}{10}} \right)$$

where

- NL = Resulting energy level,
- CL = Current energy level (NL after previous Type 15 countermeasure),
- OL = Original energy level (before any Type 15 countermeasures),
- PCNT = Fraction of sources to be treated (this is the countermeasure variable),
- DB = Decibel reduction from the treatment.

Note the following constraint:

$$\sum PCNT_i \leq 1$$

Over all Type 15
Countermeasures
On This Source

Type 18 Stationary Source Countermeasures

Once the optimized list of individual source-option combinations has been determined (see Section B-2), the actual reduction in the source levels may be accomplished.

Options 1 and 2: Minimum and Maximum Noise Level Reduction

The reduction is applied equally among day and night cells according to:

$$NL = OL \cdot 10^{\frac{-RED}{10}}$$

where

NL = Resulting energy level,
OL = Original energy level,
RED = Decibel reduction.

Option 3: Elimination of Night Operations

This is accomplished by eliminating all the noise energy from the source at each affected night cell location. Those cells defined over the daytime period remain unaffected.

Option 4: Elimination of the Source

This is achieved by eliminating all the noise energy from the source at each affected cell, both day and night.

Options 5 and 6: Elimination of Night Operations and Minimum or Maximum Reduction

Realized by applying Option 3 to the affected night cells in conjunction with Options 1 or 2 at each corresponding day cell.

The countermeasures are applied in order of increasing countermeasure type. It is important that the rerouting countermeasure be performed first so that any other countermeasure which applies to the rerouted source has those results available. Note that the stationary source countermeasures were optimized previously using a preliminary application of the other countermeasures. This preliminary application was for the specific purpose of stationary source suboptimization and constituted the first pass through the cells as described in Section B-1.

Type 20 Path-Receiver Countermeasures

When the program is compiling an optimized list of path-receiver countermeasures among the cells, it is also saving the benefits of those options on a cell-by-cell basis. These benefits are expressed in terms of the number of people no longer adversely affected by noise and are obtained from the cost/benefit ratios and benefit parameters associated with the particular option.

The actual application of the countermeasure occurs when the NII is being evaluated. The NII is calculated by summing - on a cell-by-cell basis - the number of people who remain adversely affected after the application of countermeasure Types 1 through 18. For each cell, the benefit of the path-receiver countermeasure option implemented, if any, is subtracted from the remainder figure just mentioned to obtain the net number of people who are still adversely affected by the noise climate. The grand sum of this net figure over all the cells is then divided by the total population to obtain the NII.

$$NII = \frac{\sum_{\text{cells}} (PR_i - BFT_i)}{TPOP}$$

where

NII = Noise Impact Index,

PR_i = Number of people who remain adversely affected in this cell after the application of countermeasure Types 1 through 18,

BFT_i = Benefit of the path-receiver countermeasure chosen for this cell,

TPOP = Total population of the community.

B-5 Gradient Evaluation

The gradient is calculated to indicate, at the current point, the slope of the Noise Impact Index (NII) hypersurface formed by the countermeasures (see Figure 2-9, Volume I, for a three-dimensional illustration resulting from two countermeasures). The program uses the steepest-descent technique to find the minimum point with the given constraints. The gradient for a countermeasure is an indication of the change in the NII that will result if an additional dollar is spent on that countermeasure alone. In actuality, the gradient is based on a fixed increment (not one dollar) and then normalized to one dollar.

For countermeasure Types 1 through 15, the gradient is indeed calculated by comparing the effectiveness of the countermeasure at the current expenditure level and the effectiveness of that same countermeasure at the current expenditure level plus the gradient stepsize amount. For the stationary source and path-receiver countermeasures — Types 18 and 20, respectively — the gradient is based on the next-most-cost-effective countermeasure option that would be implemented if sufficient funds were allocated to that countermeasure. In that case, the gradient expression takes on the following form:

$$\text{GRAD}_i = \frac{1}{\text{CBR} \cdot \text{TPOP}}$$

where

GRAD_i = Gradient magnitude of the i^{th} countermeasure,

CBR = Cost/benefit ratio associated with the countermeasure alternative that would next be implemented (cost of alternative is in dollars and the benefit in terms of people),

TPOP = Total population of all the cells.

There is a complication that arises with the stationary source gradient value. Since the suboptimization of the stationary source countermeasures uses the effectiveness of the path-receiver measures of the previous expenditure scenario,* the stationary source gradient value as calculated using the above expression is only an approximation. Should this

*See Section B-2, third paragraph, page B-8.

approximation be the largest of all countermeasure types, the program will automatically initiate a pseudo-expenditure evaluation which includes the next stationary source countermeasure option as well, and will use the actual difference in the Noise Impact Indices (with and without the extra stationary source measure) to calculate the gradient value. This value is assured to be correct since the path-receiver measures which are used as an approximation are the actual measures that were calculated during the evaluation of the previous expenditure scenario. Note that the approximate gradient value will always have a larger magnitude than the actual value—i.e., the approximation is calculated using a larger potential benefit of people adversely affected.

In the event that the application of the extra stationary source measure causes a change in the path-receiver benefits, the actual NII difference technique used with the pseudo-evaluation will ensure the accuracy of the gradient value.

If the stationary source countermeasure using the corrected gradient is found to be less effective than another countermeasure, the program will search the other gradients that were calculated before pseudo-evaluation. The pseudo-evaluation does not calculate gradients for the other countermeasure types.

If it is found that the next-most-cost-effective countermeasure option (either for the stationary source or path-receiver countermeasure) costs more than the total budget balance for all countermeasures, the gradient value will then be based on the next item in the list that allows us to remain within the budget. It is conceivable that even an option further down the list may be more cost-effective than the application of any of the other countermeasure types (1 through 15). If no option is within the budget, the returned gradient will be zero.

For countermeasure Types 1-15 the gradient value is computed using an energy reduction ratio, defined as follows:

$$RR = \frac{E_g}{E_r}$$

where

- RR = Energy reduction ratio,
 E_g = Source noise energy remaining after countermeasure application including gradient stepsize expenditures (this is called 'extra' application below),
 E_r = Noise energy remaining after countermeasure application excluding gradient stepsize expenditures; i.e., that energy calculated in the last step.

Since each countermeasure may apply to two sources, a reduction ratio is computed for each countermeasure on each affected source. A reduction ratio of 1.0 indicates no reduction and hence no benefit.

The reduction ratio concept is important because it maintains the same decibel value independent of the magnitude of the energy level. Therefore, we need not be concerned with the order in which the countermeasures are applied. Since the application of the countermeasures is cumulative, that is — more than one countermeasure may affect the same source — the ratio concept will result in the calculation of the same correct decibel reduction value independent of the current magnitude of the energy from the affected source.

After all the reduction ratios have been obtained, the program must convert the information to benefits in terms of people. The following expression indicates how the energy reduction ratio is used to compute the energy value for entry into the transfer function.

$$RLVL_j = \text{EXP} - \sum_{i=1}^2 \left[XN_{ij} - (RR_{ij} \cdot XN_{ij}) \right]$$

where

$RLVL_j$ = Total energy remaining at the cell with extra application of the j^{th} countermeasure (the other countermeasures are in effect at their regular expenditure levels),

EXP = Total energy remaining at the cell due to application of all the countermeasures at regular expenditure level,

XN_{ij} = Energy from the i^{th} source affected by the j^{th} countermeasure,

RR_{ij} = Energy reduction ratio for the j^{th} countermeasure on the i^{th} source.

The $RLVL_j$ value is used to compute the number of people adversely affected in each cell location with the extra application of the j^{th} countermeasure. This value is summed over all cells with the results separated for each countermeasure.

The benefit parameter must also include the actual benefit that would be obtained from the path-receiver measure (if any) in effect at the cell in question with the extra amount spent on the countermeasure in question. The absolute benefit of the path-receiver measure, in terms of people, at a cell location would be different if additional funds were spent on any countermeasure. The difference is computed and considered in the calculation of the gradient benefits.

The expression used to calculate the gradient values is:

$$GRAD_i = \frac{PEO - DPEO - PADV_i - DPPR_i}{GS \cdot TPOP}$$

where

$GRAD_i$ = Gradient value for the i^{th} countermeasure.

PEO = Total number of people adversely affected by noise in the community after the application of countermeasure Types 1-18 at their allocated expenditure levels.

$DPEO$ = Total number of people in the community that would no longer be adversely affected by noise if the selected path-receiver countermeasure options were implemented.

$PADV_i$ = Total number of people adversely affected with an extra amount spent on the i^{th} countermeasure. The extra amount is given by GS .

$DPPR_i$ = Total number of people who would no longer be adversely affected due to path-receiver countermeasures with an extra amount spent on the i^{th} countermeasure.

GS = The gradient stepsize in dollars. This is the extra amount that is spent on each countermeasure, one at a time, in evaluating the potential benefits.

TPOP = Total population of the community.

Note that the calculation of the Noise Impact Index uses three of the above variables:

$$NII = \frac{PEO - DPEO}{TPOP}$$

APPENDIX C

Variable Descriptions For Common Blocks

This section consists of a list of the common blocks in NOIZOP. In the succeeding discussion each block is briefly described followed by the variables, which are listed and defined — with their dimensions — in the order in which they appear in the block.

/ AUXOUT / — Contains information regarding the optional auxiliary print file.

LAUX A logical variable that is True if the secondary short form output (also called "auxiliary file") is to be created; False if this file is not desired.

LAUXUN The Fortran logical unit number of the device to which the auxiliary file is to be output. This variable has no meaning if LAUX is False.

/ BARDEF / — The common block that contains parameters used for barrier calculations.

BAT(2,21) An array of barrier effectiveness ratios for the 20 possible sources and two barrier heights. The extra two locations are not presently used.

NPZ(100) Cell identification for the primary cell associated with each of 100 possible barrier locations. Given zone number, NZ, and cell number, NC, for the primary cell of the Ith barrier, then

$$NPZ(I) = NZ \cdot 1000 + NC$$

NSEC(6,100) Relates primary internal cell location number for a barrier to each of the internal cell location numbers for each of three possible secondary cells. Indices 1-3 refer to the cell location numbers for the secondary cells for a low barrier height; indices 4-6 refer to cell locations for a high barrier height. While the secondary cells are usually the same for both barrier heights, there may be instances when they are not.

/CELDAT / — Contains most of the elements of the master cell data set. There is an allowed maximum of 200 cells.

ID(200) Contains the cell identification number for internal use. If NZ is the zone number and NC is the cell number, then the ID of the Ith cell is given by

$$ID(I) = NZ \cdot 1000 + NC$$

ICRIT(200) Contains three parameters packed into one variable. If the Ith cell has lower bound criterion level, LC (an integer), land use type, LU, and a day-night indicator, IDN (0 for day, 1 for night), then

$$ICRIT(I) = LC \cdot 1000 + LU \cdot 10 + IDN$$

VPOP(200) This array holds corrected population figures for each of the cells. The population is corrected for the time period over which the cell is defined. Input population is factored by 15/24 for a day cell and by 9/24 for a night cell.

VAL(200) Costs for relocation for each cell. The input value is entered in thousands of dollars but is converted to dollars before being placed in this array.

ENERGY(20,200) An array of noise source contribution levels in energy units from each of the 20 possible sources for each cell.

IND(20,200) Countermeasure manipulation indicators for each cell. Up to 20 such indicators are allowed.

ICON(20) An array of elements that determines whether or not the Ith source is to be considered in the computation of the baseline case Noise Impact Index.

RUMZ(200) Total floor area for each cell in square feet. This value is used in the calculation of soundproofing costs.

TPOP Total corrected population for the community.

BI The baseline case Noise Impact Index.

NCELZ The total number of cells defined during input. A daytime cell is counted as different from a nighttime cell.

/CMDEF / — Contains countermeasure definition data. Up to 20 countermeasures may be defined.

MTYP(20) Countermeasure type codes for each defined countermeasure. See Table 2-5 of the User's Guide (Volume I) for a listing of allowed types.

KR(20) A list of countermeasure numbers sorted in ascending order of countermeasure type codes.

NSORS(2,20) An array of source numbers (up to two) affected by each countermeasure.

ICD(2,20) An array of indicator numbers (up to two) used by each countermeasure.

NCM The actual number of defined countermeasures.

/CRITL / — The common block that contains parameters used in evaluating the adverse effect transfer function.

UPBND(15,2) This array contains 100 percent adversely affected noise levels for each of the 15 possible land use categories and each of the two time periods over which a cell may be defined, day or night. See Table 2-7 of the User's Guide for a listing of default program values.

ISH The transfer function shape indicator. ISH may range from one to five. See Figures 2-9 through 2-12 in the User's Guide for an illustration of each function type.

BLG The transfer function bulge parameter. This variable corresponds to "r" in Figures 2-9 through 2-12 in the User's Guide.

/ EXPENS / — Contains the variables which define the cost data associated with each of the countermeasures.

COSDTA(8,2,20) An array containing data points of countermeasure variable versus cost. COSDTA(I,1,J) contains up to eight countermeasure variables for the Jth countermeasure. COSDTA(I,2,J) contains up to eight corresponding costs in dollars.

COSTB(2,100) Contains barrier costs for each of 100 barrier locations. Costs for two barrier heights are stored — low and high, respectively.

COSS(4,20) Stationary source countermeasure costs for each of 20 stationary sources.

COSS(1,1) — Cost for a minimum noise reduction of the Ith stationary source.

COSS(2,1) — Cost for a maximum noise reduction.

COSS(3,1) — Cost to eliminate nighttime operations of the Ith source.

COSS(4,1) — Cost to eliminate the Ith source.

CMIN(20) The minimum allowable expenditure on each of the countermeasures in dollars.

CMAX(20) The maximum allowable expenditure. This variable defines the upper spending limits.

COSTS(20) The current expenditures on each of the countermeasures.

COSP(3,2) Soundproofing costs in dollars per square foot of floor area.
Costs are given for three grades of soundproofing and two general types of building structures — residential and commercial, respectively.

NCD(20) An array containing the number of data points (up to eight) which comprise the countermeasure cost function. Twenty countermeasure cost functions can be defined.

/ GRADIE / — Used to make available data concerning the countermeasure gradient calculation.

GRAD(20) Contains the current countermeasure gradient vector. One gradient component is calculated for each countermeasure.

IFILL(20) This array is used to indicate when the spending limit has been reached on a countermeasure.

DELTA This is the gradient stepsize.

COSNSS The cost of implementing the next-most-cost-effective stationary source countermeasure option.

COSNPR The cost of implementing the next-most-cost-effective path-receiver countermeasure option.

BUDGET This is the total budget for all the countermeasures.

/ RATIOS / — Contains benefit parameters for evaluating the suboptimization of the path-receiver countermeasure options.

PRCB(18,200) An array indicating the benefit, in terms of people no longer adversely affected by noise, for each of 18 path-receiver countermeasure situations (see Section B-3). These benefits are calculated for each cell number.

CNPR(18,200) Like PRCB, but calculated for each cell location; day and night cells have been combined where appropriate. The program has room for 200 cell locations as well as 200 cell numbers in the event the user has defined all day cells or all night cells.

/ RECPAT / — Holds various parameters which are also used in evaluating path-receiver countermeasures.

IDX(200) Contains cell identification for all physical cell locations in the community. The values stored are equivalent to ID in / CELDAT / but day and night cell identifications are not repeated.

IOPT(200) Stores the path-receiver countermeasure option that the program has decided to implement at each of the physical cell locations.

PAND(200) Total number of people adversely affected by noise in each physical cell location before the implementation of any path-receiver countermeasure.

DPAN(200) Serves a dual function (at different points in the program). DPAN stores percent adversely affected data in each physical cell location in the same fashion as PAND stores numbers of people. Subsequently, DPAN is used to hold differences in people adversely affected in each cell location due to the application of a path-receiver countermeasure.

ANOYD(200) Stores differences in people adversely affected by noise in each cell number after the application of a path-receiver countermeasure. DPAN stores this information by cell location.

IDS(1200) Contains information on how data are stored in array DOLPER. If NCL is the physical cell location number of a cell for which a path-receiver cost/benefit ratio is stored in DOLPER, and IX is the

corresponding option number for this cost/benefit ratio, then,
for arbitrary index I,

$$IDS(I) = NCL \cdot 100 + IX$$

Therefore, IDS(I) indicates which cell location and option
corresponds to the Ith cost/benefit ratio in DOLPER.

DOLPER(1200) Stores cost/benefit ratios for the application of each of
the six basic path-receiver countermeasure options (see Section B-3)
at each of the 200 possible cell locations.

IVRR(12) Path-receiver countermeasure option override array. A zero
in the Ith location precludes that option from consideration. Note
that six of the options (shown in Table 2-4, Volume 1) are combinations
of basic options.

IRP Actual number of cost/benefit ratios present in DOLPER. The
extent to which the DOLPER array has been filled.

NCL The number of physical cell locations in the master cell data set.

/ SCRACH / — A storage saving common block. It contains different arrays and
variables at different points in the program. A description by subroutine follows.
Most of the variables are local to each subroutine mentioned.

BARRD (Subroutine)

IZ(4) — Variables into which zone numbers are read for
barrier definition. Up to four cells per barrier are accepted.

IC(4) — Variables into which corresponding cell numbers are input.

A1(4) — Attenuation from a low barrier height.

A2(4) — Attenuation from a high barrier height.

TI(18) — Array containing titling information.

CMRD (Subroutine)

TI(18) - Title array.

COSTRD (Subroutine)

TI(18) - Title array.

CMN(20) - Array used to contain minimum expenditure on each countermeasure in thousands of dollars. Used for printout purposes only.

CMX(20) - Like CMN, but for maximum expenditures.

DISBRS (Subroutine) (see EQUIVALENCE statement in Subroutine XNOIM)

KRNK(T200) - Ranking index array for array DOLPER. If $KRNK(8) = 3$, then the eighth most cost-effective path-receiver countermeasure option is represented by the cost/benefit ratio contained in DOLPER (3).

ECHO (Subroutine)

BUF(22) - Used to convert cell data from internal storage to a form suitable for output.

IBUF(20) - Buffer array for printout of countermeasure manipulation indicators.

OPTIM (Subroutine)

KT(20) - Used to replace countermeasure gradients in descending order.

KS(20) - Ranking index array, like KT, for ordering gradients in ascending order.

OUTPUT (Subroutine)

CSTPR(12)—Contains total expenditures over all cells on each of the 12 path-receiver countermeasure options.

KT(20) — Used in ranking final gradients in descending order.

KS(20) — Used to indicate if the spending limit was reached on any of the countermeasures; used for printout purposes only.

PARRD (Subroutine)

TI(18) — Title array.

IRDB(3) — Used to input three grades of residential soundproofing.

ICDB(3) — Used to input three grades of commercial soundproofing.

RATRD (Subroutine)

TI(18) — Title array.

IUS(4) — Used to input four land use codes.

FAC(20) — Used to input 20 noise energy factors.

RELOC and REPCAL (Subroutine)

TVAL(200) — Relocation cost by physical cell location.

RPOP(200) — Cell population by physical cell location.

LNDUS(200) — Land use code by physical cell location.

BENE(18) — (REPCAL only) Working array which stores people-benefits of the 18 path-receiver situations before this data is placed in other arrays. Data here is summed over the day and night versions of a cell.

CC(12) — (REPCAL only) Corresponding costs for the first 12 path-receiver cases (see Section B-3).

SELZON (Subroutine)

BUF(10) — Used to input master cell data cards Type 1-5.

/ SNDPRF / — This is the block that holds the energy reduction ratios associated with the grades of soundproofing that are defined.

DB1(2) Energy reduction ratios for the first grade of soundproofing for residential and commercial land uses, respectively.

DB2(2) Like DB1, but for medium soundproofing.

DB3(2) Like DB1, but for maximum soundproofing.

/ SORST / — Contains the titles for the noise sources input at the beginning of the master cell data set.

STITL(8,21) The actual source titles for the 20 sources with 8 bytes allocated for the characters (A4, for a total of 32 characters). The twenty-first location is used to store 'ALL SOURCES' for output purposes describing the sources affected by path-receiver countermeasure.

/ STASOR / — Used to store stationary source countermeasure data.

SRED(2,20) Holds the decibel reduction levels corresponding to a minimum and a maximum reduction, respectively, for each of 20 possible stationary sources.

INSS(20) An array containing the stationary source countermeasure option number (0-6) that the program has decided to implement at each stationary source. A zero implies no countermeasure in effect.

ISOVR(6) Stationary source countermeasure option override array. A zero in the Ith field precludes that option from consideration.

NUSS Actual number of stationary sources defined.

TI(10) — Used to input countermeasure manipulation indicator titles.

SRANK (Subroutine)

XL(20) — Used to store the contribution to the NII from each of the 20 possible sources for each cell.

KR(20) — Ranking index array for ranking the noise sources by adverse affect.

XTOT(20) — Like XL, but is cumulative over all the cells.

SSPEND and XNOIM (Subroutine)

SSCB(8,20) — Cost/benefit ratios for each of eight stationary source countermeasure cases (see Section B-2) for each of 20 possible stationary sources.

IDSS(80) — Contains information regarding the stationary source cost/benefit ratios stored in CB. If JK is the stationary source countermeasure option number (1-4 only; see Section B-2), and IS is the source number, then, for arbitrary index I,

$$IDSS(I) = JK \cdot 1000 + IS$$

KS(80) — Ranking index array for array CB. If KS(1) = 15, then CB(15) contains the cost/benefit ratio representing the most cost-effective stationary source countermeasure option.

CB(80) — Contains cost/benefit ratios for each of four basic stationary source countermeasure options at each of the 20 possible sources.

STARD (Subroutine)

BUF(18) — Used to input title card. Also used to input stationary source countermeasure costs.