

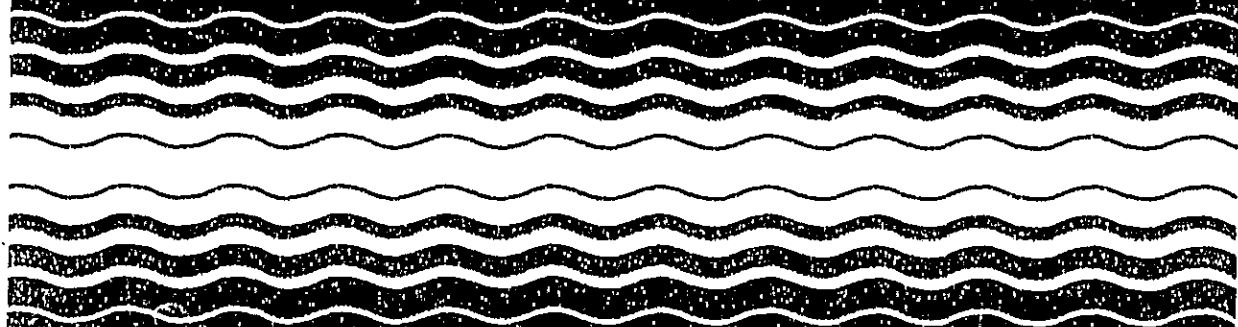

**Proceedings
Surface Transportation
Exhaust System Noise
Symposium
October 11 - 13, 1977**

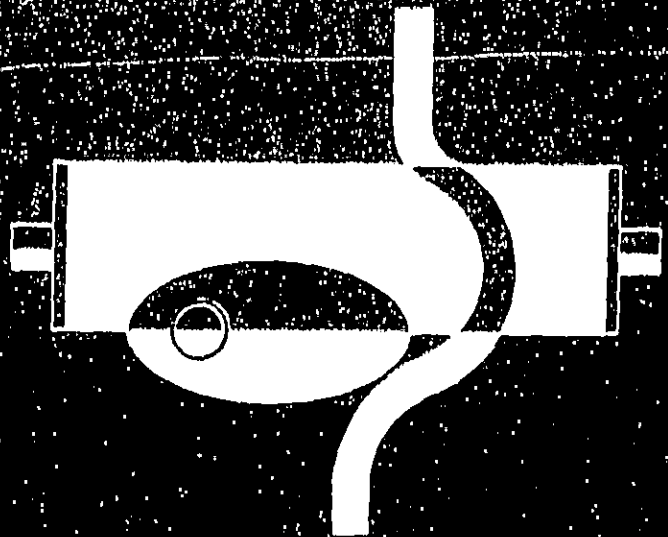

JUNE 1978

327488

U.S. ENVIRONMENTAL PROTECTION AGENCY
OFFICE OF NOISE ABATEMENT AND CONTROL
Washington, D.C. 20400

**SURFACE TRANSPORTATION
EXHAUST SYSTEM NOISE SYMPOSIUM**

OCTOBER 11, 12, 13, 1977
Howard Johnson's - O'Hare
Chicago, Illinois

Table of Contents

ANNOUNCEMENT OF SURFACE TRANSPORTATION EXHAUST SYSTEM NOISE SYMPOSIUM	iv
AGENDA	vi
INTRODUCTORY ADDRESS FOR THE SURFACE TRANSPORTATION EXHAUST SYSTEM NOISE SYMPOSIUM William E. Roper U. S. Environmental Protection Agency	1
BENCH TEST PROCEDURES AND EXHAUST SYSTEM PERFORMANCE PREDICTION P.O.A.L. Davies University of Southampton Southampton, England	5
AUTOMOTIVE EXHAUST SYSTEM EVALUATION D. A. Blaser Fluid Dynamics Research Department General Motors Research Laboratories Warren, Michigan	49
THE METHOD OF MEASURING EXHAUST SYSTEM NOISE A STUDY ON THE REDUCTION OF THE EXHAUST NOISE OF LARGE TRUCKS Mineichi Inagawa Component Testing Section, Testing Dept. Mitsubishi Motor Company Kawasaki City, Nanagawa, Japan	79
METHOD AND APPARATUS FOR MEASURING MUFFLER PERFORMANCE Peter Cheng Stemco Manufacturing Co. Longview, Texas	109
OPTIMUM DESIGN OF MUFFLERS Dr. Donald Daxa University of Wisconsin, Extension Dept. Madison, Wisconsin	115
BENCH TEST AND ANALOG SIMULATION TECHNIQUES FOR ENGINE MUFFLER EVALUATION Cecil R. Sparks Applied Physics Division Southwest Research Institute San Antonio, Texas	143

COMMENTS ON EVALUATION TECHNIQUES OF EXHAUST SYSTEM NOISE CONTROL CHARACTERISTICS	161
D. W. Rowley Donaldson Co. Minneapolis, Minn.	
A BENCH TEST FOR RAPID EVALUATION OF MUFFLER PERFORMANCE	181
A. F. Seybert Dept. of Mechanical Engineering University of Kentucky Lexington, Kentucky	
ANALYTICAL AND EXPERIMENTAL TESTING PROCEDURES FOR QUIETING TWO-STROKE ENGINES	203
Donald L. Margolis Dept. of Mechanical Engineering University of California Davis, California	
POWER OR PRESSURE - A DISCUSSION OF CURRENT ALTERNATIVES IN EXHAUST SYSTEM ACOUSTIC EVALUATION	233
Larry J. Eriksson Nelson Industries, Inc. Stoughton, Wisconsin	
A COMPUTER-AIDED APPROACH TOWARD PERFORMANCE PREDICTIONS FOR ENGINE EXHAUST MUFFLER	267
John E. Sneckenberger West Virginia University College of Engineering Morgantown, W. Virginia	
REVIEW OF INTERNAL COMBUSTION ENGINE EXHAUST MUFFLING	295
Malcolm J. Crocker Ray W. Herrick Laboratories Purdue University West Lafayette, Indiana	
SHOCK-TUBE METHODS FOR SIMULATING EXHAUST PRESSURE PULSES OF SMALL HIGH-PERFORMANCE ENGINES	359
B. Sturtevant California Institute of Technology Pasadena, California	
CORRELATION OR NOT BETWEEN BENCH TESTS AND OUTSIDE MEASUREMENTS FOR SNOWMOBILES	381
Jean Nichols Bombardier Research Center Valcourt, Quebec Canada	

MEASUREMENT OF ENGINE EXHAUST NOISE IN DYNAMOMETER ROOMS James W. Moore John Deere Haricon Works Haricon, Wisconsin	397
THE APPLICATION OF THE FINITE ELEMENT METHOD TO STUDYING THE PERFORMANCE OF REACTIVE & DISSIPATIVE MUFFLERS WITH ZERO MEAN FLOW A. Craggs Dept. of Mechanical Engineering University of Alberta, Edmonton Alberta, Canada	401
A COMPARISON OF STATIC VS. DYNAMIC TESTING PROCEDURES FOR MUFFLER EVALUATION W. L. Ronci Walker Manufacturing Grass Lake, Michigan	417
DISCUSSION OF PROPOSED SAE RECOMMENDED PRACTICE XJ1207, MEASUREMENT PROCEDURE FOR DETERMINATION OF SILENCER EFFECTIVENESS IN REDUCING ENGINE INTAKE OR EXHAUST SOUND LEVEL Larry J. Eriksson Nelson Industries, Inc. Stoughton, Wisconsin	435
A THEORETICAL EXAMINATION OF THE RELEVANT PARAMETERS FOR DYNAMOMETER TESTING OF THE 2-CYCLE ENGINE MUFFLERS Professor G. P. Blair Department of Mechanical and Industrial Engineering The Queen's University of Belfast	449
PANEL DISCUSSION	497
LIST OF ATTENDEES	547



UNITED STATES ENVIRONMENTAL PROTECTION AGENCY
WASHINGTON, D.C. 20460

August 16, 1977

SURFACE TRANSPORTATION EXHAUST SYSTEM NOISE SYMPOSIUM

Sponsored by the U.S. Environmental Protection Agency

Conducted by the Environmental Protection Agency

and McDonnell Douglas Astronautics Company at

Howard Johnson's - O'Hare, Chicago, Illinois

on October 11, 12, 13, 1977

The U.S. Environmental Protection Agency/Office of Noise Abatement and Control (EPA/ONAC) has initiated studies pursuant to requirements established under Section 0 of the Noise Control Act of 1972 which may lead to Federal requirements for the labeling of surface transportation vehicles and mufflers with respect to noise.

One study is designed to assess the methodologies available to measure and communicate the noise reduction characteristics of surface transportation vehicle exhaust systems. The information communicated may be actual sound levels or information relative to sound levels (i.e., verification that a vehicle with a particular aftermarket muffler installed will meet an applicable standard), or other information such as warranty claims, proper maintenance and operator instructions, etc. The information would be used by dealers, repair facilities, enforcement personnel and the general public.

The other study is to explore avenues available to communicate to consumers the noise characteristics of surface transportation vehicles (e.g. total vehicle noise, interior noise, etc.). This second study, however, is not the subject of this symposium.

In support of the exhaust system program the EPA desires information on possible testing procedures which could be used in a Federal muffler labeling requirement. EPA needs to know whether standardized procedures exist or can be developed that can be used to characterize muffler performance without having to test exhaust systems installed on the vehicles for which they are intended.

To gain the necessary information, EPA is sponsoring a three day symposium scheduled for October 11, 12, 13, 1977 in Chicago, Illinois. Inputs from industry, research organizations and other interested parties are solicited to provide information to the government on appropriate procedures.

Papers submitted for presentation should be directed primarily to bench test procedures and their relationship to total vehicle sound level methodologies for use in a Federal regulatory requirement. The methods discussed may include the following:

- o System testing using a standard sound source,
- o analytical simulation techniques, and
- o combination of testing and analytical methods.

Information that must be developed on vehicle or vehicle engine sound characteristics (other than total vehicle noise) to make muffler labeling useful should also be addressed.

While the primary purpose of the symposium is to assess "bench test methodologies" and their use in a Federal regulatory requirement, it may be necessary to address other testing methodologies, in the event that a suitable bench test methodology does not appear to be available. In this light a limited number of papers will be accepted on stationary (near field) and dynamometer test methods, results and their relationship to moving vehicle noise test methods.

Six sessions of in-depth papers are planned to cover all aspects of exhaust system bench testing. Three plenary sessions will be held emphasizing the application of various exhaust system bench test methods.

More information may be obtained from:

Environmental Protection Agency
John Thomas
Office of Noise Abatement
and Control (AN-471)
Environmental Protection Agency
Washington, D.C. 20460
Tel: (703) 557-7666

McDonnell-Douglas Astronautics Co.
E. T. Oddo
McDonnell-Douglas Astronautics Co.
5301 Bolsa Avenue
Huntington Beach, CA 92467
Tel: (714) 896-4412

Abstract of papers should be submitted to E. T. Oddo, MDAC no later than September 19, 1977.

Room accommodations can be arranged at:

Howard Johnson's - O'Hare
10249 West Irving Park Road
Schiller Park
Chicago, Illinois 60176
Tel: (312) 671-6000



UNITED STATES ENVIRONMENTAL PROTECTION AGENCY
WASHINGTON, D.C. 20460

AGENDA

TUESDAY 11 OCTOBER

8:30 - 9:30 am Registration

9:30 Opening Address
EPA, Washington, D.C.

SOUND GENERATION BY AN INTERNAL COMBUSTION ENGINE EXHAUST
A. J. Dramer, National Research Council of Canada,
Ottawa, Canada (Paper not available)

TEST PROCEDURES AND EXHAUST SYSTEM PERFORMANCE PREDICTIONS
P.O.A.L. Davies I.S.V.R., University of Southampton,
Southampton, England

2:00 pm AUTOMOTIVE EXHAUST SILENCER EVALUATION
Dwight Blaser, General Motors Technical Center, Warren, Mich.

THE METHOD OF MEASUREMENT FOR EXHAUST SYSTEM NOISE
Hirotchi Inagawa, Mitsubishi Motor Co., Hanagawa, Japan

METHOD AND APPARATUS FOR MEASURING MUFFLER PERFORMANCE
Peter Cheng, Stenco Mfg. Co., Longview, Texas

COMPUTER PROCEDURE FOR ASSESSING MUFFLER PERFORMANCE
Donald E. Daxa, University of Wisconsin, Madison, Wisc.

WEDNESDAY 12 OCTOBER

8:30 - 9:30 am Registration

BENCH TESTS AND ANALOG SIMULATION TECHNIQUES FOR MUFFLER
EVALUATION
Cecil Sparks, Southwest Research Inst., San Antonio, Texas

COMMENTS ON EVALUATION TECHNIQUES OF EXHAUST SYSTEM NOISE
CONTROL CHARACTERISTICS
D. W. Rowley, Donaldson Co., Minneapolis, Minn.

BENCH TEST FOR RAPID EVALUATION OF MUFFLER PERFORMANCE
Andrew S. Seybert, University of Kentucky, Kentucky

ANALYTICAL AND EXPERIMENTAL TESTING PROCEDURES FOR QUIETING
TWO-STROKE ENGINES
D. Margolis, University of Calif. at Davis, Davis, Calif.

2:00 pm POWER OR PRESSURE - A DISCUSSION OF CURRENT ALTERNATIVES IN
EXHAUST SYSTEM ACOUSTIC EVALUATION
Larry J. Eriksson, Nelson Industries, Inc., Stoughton, Wisc.

A COMPUTER-AIDED APPROACH TOWARD PERFORMANCE PREDICTIONS FOR
ENGINE EXHAUST MUFFLER
John E. Sneckenberger, West Virginia University, Morgantown, VA

REVIEW OF INTERNAL COMBUSTION ENGINE EXHAUST MUFFLING
Malcolm J. Crocker, Herrick Laboratories, Purdue University,
West Lafayette, Ind.

SHOCK TUBE METHODS FOR SIMULATING EXHAUST PRESSURE PULSES
OF SMALL HIGH PERFORMANCE ENGINES
U. Sturdevant, California Institute of Technology, Pasadena,
Calif.

THURSDAY 13 OCTOBER

8:30 - 9:30 am Registration

9:30 am CORRELATION OR NO, BETWEEN BENCH TESTS AND OUTSIDE MEASUREMENTS
FOR SHOMOBILE EXHAUST SYSTEMS
Jean Nichols, Bombardier Research Center, Valcourt, Quebec

A METHOD OF MEASURING ENGINE EXHAUST NOISE IN A DYNAMOMETER
ROOM
James H. Moore, John Deere, Horicon Works, Horicon, Wisconsin

THE APPLICATION OF THE FINITE ELEMENT METHOD TO STUDY THE
PERFORMANCE OF REACTIVE & DISSIPATIVE MUFFLERS WITH ZERO MEAN FLOW
A. Craggs, University of Alberta, Alberta, Canada

COMPARISON OF STATIC VS. DYNAMIC TEST PROCEDURES FOR MUFFLER
EVALUATIONS
W. Ronci, Walker Manufacturing Co., Grass Lake, Mich.

DISCUSSION OF PROPOSED S.A.E. RECOMMENDED PRACTICE SJ1207
MEASUREMENT PROCEDURE FOR DETERMINATION OF SILENCER EFFECTIVE-
NESS IN REDUCING ENGINE INTAKE OR EXHAUST NOISE
Larry J. Eriksson, Nelson Industries, Inc., Stoughton, Wisc.

OPENING ADDRESS SURFACE TRANSPORTATION EXHAUST SYSTEMS
NOISE SYMPOSIUM

by

William E. Roper
U. S. Environmental Protection Agency

It is my pleasure to welcome you to EPA's Surface Transportation Exhaust Systems Noise Symposium here in Chicago. This is the first major action EPA has undertaken through the labeling related responsibilities of the Agency with regard to systems and components used to a large degree in the surface transportation vehicles. In the past, EPA has set legal noise standards for medium and heavy trucks and has recently proposed noise emission standards for buses, truck-mounted solid waste compactors, and truck-mounted refrigeration units; in addition to a number of other standards applicable to non-surface transportation type vehicles. On all these vehicles, the exhaust system is one of the important noise sources and in some cases the principal source of noise. Throughout the life of a vehicle, components of the exhaust system, particularly the muffler and portions of the exhaust tubing are replaced as a routine maintenance practice on a cyclic basis throughout the useful life of the vehicle. Because of these characteristics, vehicle exhaust systems appear to be a good candidate for consideration in a Federal labeling program.

EPA has already implemented its general policy on noise labeling and recently published a notice of proposed rulemaking laying the criteria for such action. The specific objectives of EPA's labeling program in the noise area include:

(1) Providing accurate and understandable information to product purchasers and users regarding the acoustical performance of designated products so that meaningful comparisons could be made concerning the acoustical performance of the product as part of the purchase or use decision.

(2) Providing accurate and understandable information on product noise emission performance to consumers with minimal Federal involvement.

(3) Promoting public awareness and understanding of environmental noise and the associated terms and concepts.

(4) Encouraging effective voluntary noise reduction and noise labeling efforts on the part of product manufacturers and suppliers.

At this time, our study efforts are directed primarily at the assessment of available measurement methodology techniques to adequately define exhaust system noise performance. Clearly, the development of an acceptable measurement methodology to be used to determine the appropriate acoustic performance information is central to being able to properly label an exhaust system or exhaust system component. To assist the Agency in carrying out this task, we have contracted with McDonnell Douglas Astronautics Company to provide technical support in this specific area. A portion of their contract calls for the assessment of existing

and proposed total vehicle sound testing methodologies to report on the status of current muffler labeling required by Federal, State, or local regulation and voluntary labeling programs, development of a general description of the current aftermarket muffler industry and to organize and assist in conducting this symposium of acknowledged muffling system experts on the feasibility of using methodologies other than base-line total vehicle sound procedures for evaluating exhaust system noise performance.

We recognize that the area we are about to embark on is one of many technical complications and has equally sizable communication complications in order to effectively provide simplistic information to a consumer or user. The initial step however, remains the development of an acceptable measurement methodology to identify the acoustic performance of exhaust systems. The symposium for the next three days is designed to specifically focus on this issue with particular emphasis on assessment of bench test procedures and their relationship to total vehicle sound level methodologies. The methods that will be presented and reviewed in the following three days will include but not be limited to: system testing using a standard sound source, analytical simulation techniques, and combination of testing and analytical methods.

For the next three days, we will likely have assembled in this room some of the best expertise available on this subject. I hope that through a constructive and objective interchange of ideas, we as a group will be able to focus on the issues and develop specific recommendations for testing of exhaust systems that can be related to total vehicle sound levels and have potential use in a Federal regulatory labeling program.

BENCH TEST PROCEDURES AND EXHAUST SYSTEM PERFORMANCE

PREDICTION

by P.O.A.L. DAVIES

SUMMARY

This contribution reviews the present state of development of a rational approach to exhaust system performance evaluation based on static test bed measurements. This depends primarily on a quantitative understanding of the generation and propagation of sound energy in ducts which are carrying a hot, high velocity gas flow.

Elements of the approach are described which include methods for characterising the sources, analytic or experimental methods for adequately modelling the acoustic behaviour of system components, appropriate precautions for assessing inter-component interactions and a scheme for identifying those situations where source system interactions can be important.

Component models are expressed in terms of transfer matrices, or their equivalent, relating the pressure and volume velocity at input to output. A useful range of linear analytic models for reactive system components is described. Examples are presented comparing bench measurements with predictions for a representative set of practical systems including the U.K. Quiet Heavy Vehicle Project.

BENCH TEST PROCEDURES AND EXHAUST SYSTEM PERFORMANCE PREDICTION

1. INTRODUCTION

A systematic and rational approach to the control of piston engine intake and exhaust noise requires a quantitative specification of the silencing requirements, with a procedure for the quantitative evaluation of system acoustic and mechanical performance. This contribution reviews the present state of development of such an approach which is based on bench testing. Such tests concern primarily test bed measurements with a running engine, but some of the details required for modelling system elements and their behaviour have been provided with special cold flow rigs.

The prediction of system performance usually concerns the calculation of the transport of acoustic energy through the system from the source to the outlet where it is radiated, [1]. For this one requires a set of models which describe the acoustic transfer characteristics of each system element in quantitative terms [2], with an analytical procedure for combining the elements together to describe the overall transport of energy through the complete system [2, 3]. An element may be described as any part of the duct system that has an effect on the propagation of acoustic waves (or energy) through it. Thus, in this connection, the engine, sections of connecting pipe, the open end of the system and any duct discontinuity or muffler component are all acoustic elements.

Silencing requirements are normally determined by first performing open pipe noise measurements, covering the full operational load and speed conditions of the engine. This information can then be compared with the statutory or specified noise limits to provide a quantitative description of silencing requirements. If the open pipe data are properly evaluated, they can also be used to describe the acoustic source characteristics of the engine. This information provides a starting point for the quantitative evaluation of the inlet or exhaust system acoustic performance. Thus open pipe measurements with a loaded engine represent one essential part of the test procedure.

Acoustic performance is generally described in terms of insertion loss. This can be defined as the difference in sound pressure level, measured at a fixed reference point, between the noise emitted by an open pipe and the noise emitted by the silenced intake or exhaust. Note that this definition assumes that the observed difference is due to the presence of a muffler unit in the system and that the source remains unchanged.

When the system is modified, it is well established [4] that the observed performance can be strongly influenced by the relative positioning of the muffler unit along the exhaust or inlet duct. That this should happen is well understood, since the sections of pipe connecting components of the system each have a clearly identifiable acoustic behaviour, depending on their length. This then forms part of the installed response of the muffler unit. For this reason transmission loss alone is not an appropriate practical method for describing the acoustic performance of intake or exhaust system components.

Mechanical performance can be assessed in terms of the effect of the intake and exhaust system on engine power and efficiency. Other mechanical factors include the packaging of the system components to minimise flanking transmission, cost and weight, to provide adequate durability and to fit in with dimensional or other installation constraints. Some of these considerations have a direct effect on acoustic performance and must be included in the noise control analysis.

The intake and exhaust gas is normally flowing sufficiently rapidly for this to have a significant effect on acoustic performance. Furthermore, the exhaust gas is hot, so significant temperature gradients exist which change with engine (or vehicle) speed and load. Due allowance for these operational and gas flow factors must be made during the performance predictions and sufficient data for this purpose assembled during the measurements. The mean kinetic energy of the gas flow may also be converted to new sources of acoustic energy within the intake or exhaust system, appearing either as broadband flow noise, or as regenerated pure tone components. Finally, there is good evidence [5] that changes in system acoustic characteristics may also modify the engine breathing characteristics and consequently the acoustic source strength of the engine.

In summary, the procedures for bench testing and system performance prediction for inlet and exhaust noise control can usefully be subdivided into a set of study areas, namely:

- a) Methods for measuring and characterising the acoustic source.
- b) The specification of silencing requirements.
- c) The assessment of operational factors with their relative significance. For example, gas flow and gas temperatures, mechanical performance, space constraints and flow or internal noise generation.
- d) Methods for modelling the acoustic transfer characteristics of the system elements based on performance measurements or an analysis.
- e) A procedure for assembling the elements together to provide an appropriate description of the system, including all the interactions between elements.
- f) An appropriate procedure for predicting or determining overall system performance including techniques to identify problems arising from source system interaction.

Each of these factors will be considered in the light of current knowledge and practical experience, indicating the level of confidence with which the evaluation can be performed at the present time.

2. ACOUSTIC ENERGY PROPAGATION IN FLOW DUCTS

Sound propagation in flow ducts can be described by linear transmission line equations. These are based on conservation of mass, energy and momentum and describe the variation of acoustic pressure and particle velocity associated with the wave motion in terms of position in the duct. In their simplest and perhaps most practical form the flow and the wave motion are both assumed to be one-dimensional. With these restrictions exact solutions can be obtained for a comprehensive range of duct geometry and boundary conditions. However, if the solution is to remain realistic in terms of observed behaviour, special considerations may be necessary to specify acoustic conditions at discontinuities, as will be shown later.

Empirical descriptions of acoustic performance become necessary where a system element exhibits a strongly non-linear behaviour. Such can be the case, for example, with acoustic transmission through orifices with normal or grazing flow, or with sound transmission along passages lined with absorbing materials. Other examples include flow-acoustic coupling and amplification associated with flow separation or edge-tones as well as flow noise. Some examples of such behaviour are also considered later.

2.1 Plane wave propagation in flow ducts

Acoustic energy propagation is by a wave mechanism, the energy being provided by a source which excites the wave motion. At each duct discontinuity some of the energy is transmitted as a new wave the remainder being reflected, both waves travelling with a phase velocity c relative to the gas. With one-dimensional wave propagation in ducts one can describe the pressure p^+ and particle velocity v^+ in the positive going (incident) wave by

$$p^+ = \hat{p}^+ e^{i(\omega t - k^+ x)} e^{-\alpha x} \quad , \quad 2.1(a)$$

$$v^+ = \frac{\hat{p}^+}{Z_a} e^{i(\omega t - k^+ x)} e^{-\alpha x} \quad , \quad 2.1(b)$$

where \hat{p}^+ and \hat{v}^+ are the pressure and velocity amplitudes, ω the radian frequency, k^+ the wave number $\omega/(c+U)$, U the mean flow velocity and α a coefficient which represents the decay of wave energy as it propagates along the duct. Similarly the reflected wave is described by

$$p^- = \hat{p}^- e^{i(\omega t + k^- x)} e^{-\alpha x} \quad , \quad 2.2(a)$$

$$v^- = \frac{\hat{p}^-}{Z_a} e^{i(\omega t + k^- x)} e^{-\alpha x} \quad , \quad 2.2(b)$$

where $k^- = \omega/(c-U)$.

An alternative description is to express the pressure etc by $\hat{p}^+ e^{i\omega t} e^{-\gamma x}$, where $\gamma = \alpha + i\beta$. With hard walled ducts $\alpha=0$ and $\beta=k^+$ while the duct impedance $Z_a = \rho c$, the characteristic acoustic impedance of the gas. The sound pressure and particle velocity at any point are then given by

$$p = p^+ + p^- \quad 2.3(a)$$

$$v = v^+ + v^- \quad 2.3(b)$$

To represent discontinuities, one first notes that some of the incident wave energy will be reflected and some transmitted. The ratio (usually complex) of the reflected to incident wave amplitude, termed the reflection coefficient r , is expressed by

$$r = \frac{p^-}{p^+} = \frac{Z_D - Z_a}{Z_D + Z_a} = R e^{i\phi}, \quad 2.4$$

when the boundary conditions at the discontinuity are specified as an impedance Z_D . For an open end, the phase angle ϕ can be obtained from the solution given in [6] for zero flow. The appropriate value of R for various flow Mach numbers U/c can be found in [1]. Similar relations for a baffled opening can be found in [7].

Neglecting, for simplicity, the attenuation along the duct, with 2.4 describing conditions at x_0 , then the pressure amplitude \hat{p}_x at any other point x in a plain duct is given by

$$\begin{aligned} \hat{p}_x &= \hat{p}_0 (e^{-ik^+x} + R e^{i\phi} e^{ik^-x}) , \\ &= \hat{p}_0 (e^{i(k^- - k^+)x/2} [e^{-ik^+x} + R e^{i\phi} e^{ik^+x}]) , \quad 2.5 \end{aligned}$$

where $k^* = \frac{1}{2}(k^+ + k^-) = \omega/c(1-M^2)$. This shows that the distance between the nodes of the standing waves is reduced by the factor $(1-M^2)$ with flow present, compared to the zero flow case. Thus the existence of flow modifies the frequencies at which lengths of duct (and other elements) resonate.

2.2 Acoustic Conservation relationships for flow ducts

With plane waves in a uniform flow duct, conservation of mass is satisfied [2] if

$$\frac{A}{c} [(1+M)\hat{p}^+ - (1-M)\hat{p}^-] = \text{a constant}, \quad 2.6$$

where A is the duct cross-section area.

Similarly it can be shown that, for isentropic conditions, conservation of energy is satisfied if

$$(1+M)\hat{p}^+ + (1-M)\hat{p}^- = \text{a constant.} \quad 2.7$$

Given a uniform duct of length l with a steady flow of Mach number M , one can show that conservation of acoustic energy and of mass flow for non-decaying waves is satisfied by the simple transfer relationships

$$\hat{p}_l^+ = \hat{p}_0^+ e^{-ik^+l} \quad \text{and} \quad \hat{p}_l^- = \hat{p}_0^- e^{ik^-l}. \quad 2.8$$

The termination conditions are often defined by

$$Z_0 = \frac{\rho c (\hat{p}_0^+ + \hat{p}_0^-)}{\hat{p}_0^+ - \hat{p}_0^-} \quad \text{and} \quad Z_l = \frac{\rho c (\hat{p}_l^+ + \hat{p}_l^-)}{\hat{p}_l^+ - \hat{p}_l^-}. \quad 2.9$$

This result indicates that it is necessary to include measurements of flow temperature and mean mass flow, to evaluate k^+ , k^- and M . If the duct wall pressure p_0 is measured or determined, one also requires a knowledge of Z_0 before p_0 can be decomposed into its two components p_0^+ and p_0^- . However, given Z_0 , Z_l can then be evaluated, and so on. Since the open pipe discharge impedance Z_D can be specified from established data, the modelling of system characteristics can conveniently begin here. The decay of the wave amplitude in ducts of significant length can be included by multiplying the right-hand side of 2.8 by a factor $e^{\alpha l}$, with α negative and dependent both on frequency and Mach No.

At discontinuities, however, the assumption that the flow is isentropic is hardly realistic, particularly at the rapid changes in duct cross section that occur in expansion chambers etc. The transfer characteristics can be established, however, along the lines set out in reference [2]. Flow losses and the consequent entropy changes can be represented by a loss factor δ . (but see [8]). Describing acoustic and flow properties before the discontinuity by the subscript 1 and those well downstream by the subscript 2 and neglecting changes in mean density, one can set out the conditions for conservation of mass flow, energy and

momentum flux across the discontinuity.

Conservation of mass is expressed by

$$\Lambda_2 [\hat{p}_2^+(1+M_2) - \hat{p}_2^-(1-M_2)] = \Lambda_1 [\hat{p}_1^+(1+M_1) - \hat{p}_1^-(1-M_1) + \delta M_1], \quad 2.10$$

while conservation of energy is satisfied if

$$\hat{p}_2^+(1+M_2) + \hat{p}_2^-(1-M_2) = \hat{p}_1^+(1+M_1) + \hat{p}_1^-(1-M_1) - \delta/(\gamma-1), \quad 2.11$$

where γ is the ratio of the specific heats. Momentum is conserved if

$$\begin{aligned} & \hat{p}_2^+ [A_1 + \Lambda_2(2M_2 + M_2^2)] + \hat{p}_2^- [A_1 + \Lambda_2(M_2^2 - 2M_2)] \\ & = \hat{p}_1^+ [A_1(1+M_1)^2] + \hat{p}_1^- [A_1(1-M_1)^2] + \delta \Lambda_1 M_1^2. \end{aligned} \quad 2.12$$

For one-dimensional flow, and known geometry, the incident and reflected waves \hat{p}_2^+ and \hat{p}_2^- after the discontinuity can be found in terms of the known incident and reflected waves before it, after the unknown loss factor δ has been eliminated from the three equations. Thus these three equations can be used to define a transfer relationship for any area discontinuity. Other types of discontinuity can be treated using a similar approach. One should note that the phase changes occurring across the discontinuity can be determined from a non-propagating higher order mode analysis, for zero flow, that satisfies the boundary conditions.

The mean acoustic energy flux per unit area of duct, or the acoustic intensity, is expressed as

$$I = \overline{p v}$$

where p and v are the r.m.s. pressure and velocities respectively and the overbar represents a time average. In terms of the wave components this becomes, using 2.6 and 2.7,

$$I = \frac{1}{2\rho c} [(1+M)^2 \langle (\hat{p}^+)^2 \rangle - (1-M)^2 \langle (\hat{p}^-)^2 \rangle] \quad 2.13$$

where the symbol $\langle \rangle$ represents taking the time mean value. The first term in the brackets can be interpreted as an energy flux with the flow or the incident wave motion, while the second represents energy flux against the flow, or energy carried by the reflected waves.

The level of the sound radiated by the exhaust outlet can be obtained by equating the nett energy in the tailpipe to that of a spherically diverging wave. This gives for a tailpipe of radius a

$$\frac{\pi a^2}{2} \frac{\langle \hat{p}_0^+ \rangle^2}{\rho_0 c_0} [(1+M)^2 - R^2(1-M)^2] = \frac{4\pi r^2}{\rho_r c_r} p_r^2 \quad 2.14$$

where p_r is the r.m.s. acoustic pressure measured at a distance r from the outlet. Equation 2.14 can be employed to determine the fluctuating pressure level in the tailpipe from free field measurements, provided the Mach number and radiation impedance are known.

The analysis presented above is restricted to situations where the behaviour can be characterised by linear acoustic theory. Examples are presented which indicates that this assumption is not restrictive for many practical applications. The analysis presented is not the only effective way of describing system characteristics since an alternative approach using transfer matrices has been described elsewhere [3], [4]. Though omitted for simplicity, the analysis can be extended to the decay of the waves as they propagate. Axial temperature gradients may also be accommodated by sub-dividing elements into smaller sections where the temperature can be regarded as substantially constant.

2.3 Some examples of sound transmission across discontinuities

To complete this review of acoustic energy propagation in ducts, some examples are presented comparing the measured characteristics of some typical discontinuities obtained with flow rigs with predictions based on the analysis presented here. A further series of comparisons based on test bed or field measurements with silencer components and systems can be found in references [1]; [2]; [5] and [9].

The first example concerns acoustic energy transport across a

contraction which includes a sidebranch. The measurements were performed with a special cold flow rig provided with a high intensity acoustic source. Figure 1(a) presents the measurements made at three flow Mach numbers, the predictions assuming plane wave motion throughout and a higher order mode (exact) analysis for zero flow. The plane wave analysis, represented by equations 2.10 to 2.12, cannot model the zero acoustic particle velocity boundary condition on the wall at the annulus between the inner and outer pipes forming the contraction. The zero particle velocity condition here can be closely approximated by including the first five radial modes, and this calculation provides the exact result shown in the figure.

Comparison with the measurements shows that the plane wave analysis, which includes a small decay factor for the waves in the sidebranch, correctly predicts the amplitude of the transmitted waves, as can be seen in Figure 1(b), but there is a constant frequency error. The exact analysis for zero flow does however predict the frequency correctly. Thus a combination of both methods of analysis provides an adequate description of the transfer characteristics of the discontinuity, with plane wave analysis defining amplitude characteristics and higher order mode analysis the phase change.

A second example concerns an area expansion with a sidebranch and the results are illustrated in Figure 2(a) and 2(b). In this case the boundary conditions at the discontinuity must also include the fact that the flow separates at the end of the pipe, forming a jet. A detailed analysis of this problem has been presented by Cummings [10] who shows that amplitude characteristics are correctly predicted if the pressure waves are assumed plane, but that the flow retains a top hat velocity profile. Again comparison with measurements shows that amplitude characteristics are adequately modelled by plane wave theory and that the correct phase change can be predicted by higher order analysis.

The higher order mode analysis is laborious and a systematic investigation [11] showed that the phase change can be calculated by an appropriate end correction. This is analogous to the well known end correction of just over 0.6 of the pipe radius that is applied for

predicting the acoustic resonance of organ pipes to account for fluid inertia effects at the discontinuity. The end corrections appropriate to expansions or contractions in flow ducts are illustrated in Figure 3. The dotted line indicates the lower frequency limit for propagating higher order modes when plane wave analysis breaks down. It can be seen that the corrections tend to the open pipe limit at large area ratios. Furthermore, as a percentage of the duct length, they become small for long connecting pipes and could be neglected in practical prediction calculations.

A third example concerns the performance of folded chambers. Effectively these can be regarded either as a Helmholtz resonator, or a sidebranch, which for convenience of packaging is wrapped around the expansion section. This geometry has the added advantage of avoiding high velocity cross flow at the resonator neck, avoiding problems with flow excitation. A detailed analysis including higher order modes to match boundary conditions at the three connecting annuli has been reported by Cummings [12]. The predictions with an alternative and simpler approach based on end corrections etc. by Adams [11] is compared with flow rig measurements in Figure 4. This illustrates the way that the system resonance can be modified by changing the area of the neck, a useful feature for tailoring acoustic characteristics within spacial constraints. The good agreement between predictions and observations illustrates the effectiveness of the modelling techniques described above.

2.4 Acoustic sources in intake and exhaust systems

An account of acoustic energy propagation in flow ducts would be incomplete without some consideration of the sources. The primary sound source provided by the unsteady flow processes at the valve. The amplitude of these pressure fluctuations can be as high as 0.5 bar, while the frequency spectrum consists of the first 100 or more harmonics of the fundamental firing frequency for one cylinder. One can show, by dimensional reasoning, that the source strength at any fixed frequency varies as N^5 , where N is the engine rotational speed. Broadband noise at higher frequencies is also provided by broadband flow noise generated at the valve, and at discontinuities where the flow can separate. This

spectrum exhibits a flat peak at a characteristic Strouhal number FL/U of around unity, where L is a characteristic scale of the source region and U the phase velocity of the disturbances acting as sources. Such noise will vary, at fixed frequencies, as N^7 . Noise generated by flow turbulence at the duct walls, bends etc. may also represent a significant source of high frequency sound. Its strength will vary as V^6 , where V is the mean duct flow velocity.

Turbocharging modifies the exhaust noise signature since it tends to reduce the amplitude of the low frequency components arising from gas release processes. It may add new sources of noise generated by unsteady flow interactions in the turbine or blower, by wake noise from the blades or nozzles and so on. The strength of such sources tends to vary as V_0^6 where V_0 is the mean turbine outlet flow velocity. The characteristic frequencies of such sources may be high, of the order of the turbine blade passing frequency and its harmonics.

The strength of the sources associated with the engine breathing or the turbocharger can be studied and evaluated on the test bed. Flow noise and acoustic regeneration within the silencer system represents a different problem that can better be studied with special rigs. These latter are generally lower in intensity than those associated with the engine but are of practical significance since they set an upper limit to the maximum attenuation that can be obtained unless care is taken to minimise them.

Flow noise is broad band, generated by flow separations at valve lips, bends, expansions, contractions and by turbulent boundary layer flow. It is of most significance when amplified by cavity resonances which provide feed back to intensify the source. Noise generation by the impingement of the jet formed at the chamber entrance on the lip of the exit pipe in a steady flow rig is illustrated in Figures 5 and 6. The broad band spectrum in Figure 5 has been modulated by tailpipe (peaks) and chamber (troughs) resonances. Figure 6 illustrates the way source strength varies with pipe separation x/d and with flow velocity. Practical separations lie close to $x/d = 2$, where the strength is greatest. Scaling the measurements to correspond to a 75 mm diameter tailpipe with a flow Mach number of 0.26 at 600°C yields a sound pressure

level of 85 dBA at 7.5 metres. This represents a minimum level for tailpipe self-excitation unless this noise producing mechanism can be suppressed.

Figure 7 indicates how this source of noise can be controlled or reduced in strength by bridging the gap between the inlet and outlet with a perforated pipe. The acoustic behaviour of the expansion chamber is not significantly changed if the perforated pipe has about 20% open area, that is the hole pitch is of the order of twice the hole diameter. Perforate C had slotted holes 1.9mm across at 3.8mm pitch giving an open area of 20%, while perforate D had holes 4.5mm diameter at 7.5mm pitch giving an open area of 27%. The details of the hole formation can be critical if high frequency discrete tone generation (singing) by the perforate is to be avoided. Figure 8 shows that perforates are of value in reducing back pressure and indicates the magnitude of the back pressure penalty that must be accepted, when sharp changes in flow direction are employed in a silencer system.

The measurements in Figures 5 to 8 correspond to steady flow rigs with a specially acoustically treated quiet supply system. Other experiments were performed with single tone high level (up to 160 dB) acoustic excitation. Some typical results are illustrated in Figure 9. The solid lines on the figure represent the amplitude transfer characteristics calculated by the linear acoustic methods described earlier. The behaviour of an acoustically excited jet has been studied in connection with jet noise and is fairly well understood [13], but the mechanisms are non-linear and have been difficult to quantify. The results illustrate (a) a relative increase in transmitted sound at low forcing levels due to high amplification by the shear layer, (b) a close approach to predicted transmission at high levels of excitation due to saturation when the shear layer amplification becomes negligible, and (c) a complex interaction between the travelling vortex potential field, the sound field and the tailpipe resonance at intermediate levels of forcing. Fortunately, this complex non-linear behaviour can be effectively suppressed by fitting perforated bridges as illustrated by the measurements in Figure 10.

An example which illustrates this noise generation mechanism in more detail is provided by the acoustically synchronised vortex shedding that is found at an expansion. The observations and analysis are illustrated in Figure 11. The acoustic standing wave with zero flow that is predicted by linear acoustic analysis with 130 dB excitation in the upstream duct is shown in Figure 11(a). This wave can be described by

$$p_a(x,t) = \hat{p}_a \sin k_1 x e^{i\omega t}.$$

The form of the travelling potential field associated with the shed vortices in Figure 11(b) has been developed from a number of observations of excited jet flows [11]. It is an estimate rather than a prediction but can be closely described by

$$p_v(x,t) = \hat{p}_v e^{-\alpha k_2 x} e^{i(\omega t - k_2 x + \phi)}.$$

The combined pressure distribution is the sum of the potential and acoustic fields. The mean square value of the sum has been calculated and then plotted for comparison with observations made with a travelling probe microphone in Figure 11(c). The agreement is within the accuracy of the measurements.

Though not efficient radiators in free space, the travelling potential field of the vortices can interact with nearby surfaces which then may radiate strongly. This is what appears to happen within the expansion chamber, the effect being amplified by resonance in the chamber and tailpipe. The role of the perforate bridge is thus to suppress the vortex formation while leaving the other acoustic properties unaffected.

It is tempting to speculate whether, perhaps, many of the non-linear acoustic characteristics found with silencer elements or silencer systems may not be the result of similar mechanisms that include vortex shedding at discontinuities.

3. MEASUREMENT AND PREDICTION OF EXHAUST SYSTEM ACOUSTIC PERFORMANCE

As outlined earlier, evaluation of exhaust system acoustic performance is based on insertion loss measurements or predictions. For this purpose open pipe (unsilenced) system measurements on a test bed are required as well as measurements with the muffler units included. The prediction of insertion loss involves ideally, first calculating the transfer characteristics of the open pipe and then, starting at the tailpipe, calculating the transfer characteristics of the system with silencer units included. The insertion loss can then be calculated from the ratio of the two transfer characteristics.

For simplicity (see for example [9]) the open pipe transfer characteristics may be taken as unity, and the predicted attenuation of the system is then taken as the insertion loss. This can be acceptable in situations where the run of exhaust pipe between engine and muffler is at least two or more wavelengths long at the lowest exhaust frequency, with the muffler situated near the exhaust discharge. Predicted attenuation may not correlate well with measurements of insertion loss when the exhaust pipe is relatively short and the system contains two or more distributed muffler units set well apart.

As mentioned earlier, the transfer characteristic can be calculated working with the incident and reflected waves as described here, or by using transfer matrices representing the relation between input and output pressure and volume velocity for each element. The two methods should give precisely the same results, if based on the same assumptions and boundary conditions, as long as the input to each element in turn is taken as the output of the preceding one.

This procedure is valid so long as the source characteristics remain invariant at each of the prescribed engine running conditions. Uncertainties will also arise due to flow noise generation within the system unless due allowance for this can be included in the model for each element. From what has been shown already, it is clear that the appropriate flow and temperature conditions must always be included in the analysis.

3.1 Source characteristics

The acoustic source characteristics of the engine can be deduced from open pipe measurements. To illustrate how this can be carried out we must first set out a model of the system which identifies the source as an element.

The primary sources are provided by the unsteady flow through the valves which can be represented acoustically by a fluctuating volume velocity. To complete the description of the source one must also specify the effective source impedance. Each valve flow provides an individual contribution to the total source strength which combine in the manifold. A convenient reference plane for definition of source characteristics is therefore the manifold or turbocharger outlet flange.

The source strength can be specified at this reference plane as a fluctuating volume velocity U_m with an effective source impedance Z_m , both being quantified as complex variables. The exhaust system (or inlet system) represents an acoustic load applied to the source. This can be specified as a fluctuating volume velocity U_u with an effective impedance Z_u . With these definitions the acoustic model of the source and system appears as shown in Figure 12.

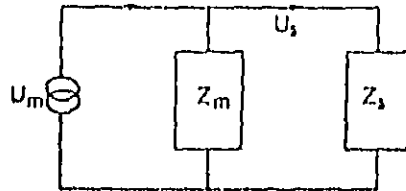

Figure 12 Acoustic model of engine and exhaust system

The driving pressure at the manifold or turbocharger outlet flange p_s can be expressed as

$$p_s = U_u Z_u = (U_m - U_u) Z_m \quad 3.1$$

Acoustic measurements obtained with microphones or transducers are usually expressed as sound pressure levels. This information is usually

reported as the root mean square value of the pressure. Such information, e.g. P_g which is an r.m.s. pressure say, is not directly comparable with the sound pressure p_g defined by equation 3.1, since phase information has been discarded in the signal processing.

3.2 Open pipe measurements

Open pipe noise measurements are usually sound pressure level recordings made under effectively free field conditions. The results are normally presented as a narrow band spectrum of the radiated noise and represents the radiated sound energy. Thus the record represents the spectrum of the signal P_T in equation 2.14. Provided the necessary flow data have been recorded at the same time, this information, together with a definition for tailpipe impedance Z_D , can be used with equation 2.14 to evaluate the amplitude spectrum of the tailpipe incident wave \hat{p}_0^+ .

With a straight open pipe of length l , the fluctuating volume velocity U_g , at the source plane can then be calculated as

$$U_g = \frac{A\hat{p}_0^+}{\rho c} \left[(1+M)e^{-ik^+l} - R(1-M)e^{i(k^-l+\phi)} \right] e^{i\omega t} \quad 3.2$$

where A is the cross section area of the pipe. The pressure at the driving plane, p_g can be found from

$$p_g = \hat{p}_0^+ \left[(1+M)e^{-ik^+l} + R(1-M)e^{i(k^-l+\phi)} \right] e^{i\omega t} \quad 3.3$$

Repeating the observations, with a different acoustic load (i.e. change of l) provides a second estimate of U_g and p_g . Provided U_m and Z_m are unaffected by changes in Z_g , this information can be used to solve equation 3.1 for these two variables which characterise the source. Some evidence exists [11] that U_m and Z_m remain unaffected with a turbo-charged engine, but will alter with a change in Z_g for a single cylinder naturally aspirated engine.

Alternatively, one can predict the insertion loss or predict the sound radiated by a silenced system from the open pipe measurements.

REST AVAIL ABU F COSY

The observed radiated spectra are adjusted assuming U_m remains unaltered, but rather than p_o^+ changes as the system is altered, in accordance with the known changes to Z_b . This procedure is illustrated by the results in Figure 13. The measurements were taken from reference 14, and were obtained on a special flow rig where the volume velocity of the source was maintained constant. The results show that the silenced system performance can be closely predicted from the open pipe measurements using linear plane wave theory even though the pressure wave amplitude was in excess of 0.5 Bar.

The calculations for the comparisons in Figure 13 were fairly straightforward, since the flow temperature, mass flow and source frequency were all constant. Test bed measurements on an engine involve covering a wide range of speed and load conditions, which result in large changes in flow temperature and temperature gradients, mass flow velocity, source strength and so on. In noise control analysis for the engine, the predicted system performance must provide a specified though perhaps different minimum insertion loss for each operating condition.

The problem can be simplified somewhat, by first assembling the measured data in the most general way. One method of doing so is illustrated in Figure 14. The upper figure is a carpet plot of a narrow band analysis of the open pipe radiated noise for five engine speeds at full load torque. Each record has been normalized in sound pressure level by dividing by the corresponding mean flow dynamic head at the manifold exit plane. This provides a plot where the increase in radiated sound pressure due to increased engine speed has been normalized.

A second normalization has been carried out on the data in Figure 14(b). The data from each run have been replotted on a basis of k^2L (see equation 2.5). The modulation of the radiated noise amplitude is clearly in step with the open pipe load impedance changes. Figure 14(b) then represents the presentation of open pipe data for which insertion loss comparisons are most likely to correspond to predicted system performance.

3.3 Comparisons between predicted and measured system performance

One example of a comparison between the measured performance of an exhaust system and that predicted with linear acoustic theory from open pipe measurements was presented in Figure 13. A further example of a similar comparison based on measurements with an engine on a test bed is presented in Figure 15 and 16. These results formed part of the systematic exhaust system bench test and design studies for the quiet heavy vehicle project sponsored by the Department of the Environment in the United Kingdom.

The unsilenced noise of this turbocharged engine was 105 dBA at 7.5 metres under full load with an open pipe exhaust system. The design specification for the system required exhaust levels below 70 dBA at 7.5 metres for any speed or load condition with a back pressure limit of 45 mm of mercury. Open pipe measurements were performed and analysed using the linear acoustic methods already described in this report. The resulting open pipe noise 1/3 octave spectrum is shown by the full line in Figure 15. Included within this figure are two further sets of spectral measurements with a silenced exhaust. The two silenced systems were of the same design which is also sketched in Figure 15, but the perforated bridges were omitted in one of them. The acoustic performance predicted for the design, neglecting flow noise, is also plotted in the figure.

The results for the two silenced systems demonstrate the value of perforate bridges for suppressive flow noise. They also confirm that flow noise levels of around 85 dBA can be expected if the bridges are omitted as implied by the results in Figure 7. The performance of both systems predicted by linear acoustic theory is the same if the flow noise excitation by vortex shedding at the expansions is ignored. However only in the case of the system with the perforate bridges can good agreement be found with the predicted performance, since only with these present have the non-linear acoustic regeneration effects been suppressed.

There is a significant discrepancy between predicted and measured performance around 1600 Hz. The reason has not been established but tailpipe resonance might be responsible, while it is worth noting that this is just above the frequency when the first of the higher order propagating modes will become cut on.

The measured insertion loss for the system with bridges is recorded in Figure 16. The information plotted here is raw data with no attempt to account for modifications to the open pipe measurements to allow for changes in flow conditions (e.g. temperature). The cross-hatching indicates the range of variation that this can produce, since careful measurements with difference acoustic loads had already indicated that this engine behaved acoustically as a constant volume velocity source at each mechanical load and speed. The predicted insertion loss was in excess of 35 to 40 dB above 200 Hz, while the measurements indicate two pronounced dips in the neighbourhood of the 1250 Hz and the 4000 Hz, 1/3 octave bands. This result reinforces the suggestion that acoustic energy propagation in the higher order modes might be responsible for the discrepancy. Calculations show that the first circumferential mode corresponds to about 1200 Hz in the expansion chamber and 3000 Hz in the pipe with the flow conditions in these components. These observations indicate that the predictions of linear plane wave theory will only be reliable at frequencies below those at which acoustic energy will propagate in the higher order modes. A proper understanding of higher order mode propagation with flow present lies to the future.

3.4 Some observations concerning pressure measurements

The measurements of the sound energy radiated from the exhaust outlet is a well established technique and should present few problems. The interpretation of the results is also straightforward provided free field conditions obtain for the experiments. The measurement of pressure within the duct poses more severe experimental problems, since both incident and reflected wave systems exist together producing standing waves.

A traditional approach to standing wave measurements is to employ a traversing probe microphone. This is a laborious procedure and requires great care if reliable observations are to be obtained. A full account of the experimental problems appears in reference 1. Special care is also required in the interpretation of the results of pressure traverses near expansions, due to the non-acoustic potential fields that can exist there, see for example Figure 11. Except for special research situations this does not appear a satisfactory or practical technique for

REST AVIATION P 0000

normal production test bed measurements for component evaluation.

An alternative is to employ wall pressure measurements, but these may involve practical problems in the evaluation of the information obtained. There is no serious problem if there are no standing waves or disturbed flow in the pipe, a condition that obtains with some transmission loss measurements. However, with any practical system strong standing waves will always be present. The problems created by their existence can be overcome, if simultaneous records are obtained with two pressure gauges. These should be sited on the wall with a separation that is less than the wavelength of sound at the highest frequency for which pressure measurements are required. Fast Fourier transform techniques can be employed to extract the amplitudes of the positive and negative travelling components of the standing wave system from these two signals. This procedure relies on the assumption that the waves are plane and that the pressure signals are wholly acoustic, so may not be appropriate downstream of bends or other discontinuities which introduce strong disturbances in the flow.

A third possibility is to make simultaneous observations of wall pressure and particle velocity at the same duct position. Simultaneous pressure and particle velocity measurements are particularly suitable for direct application in matrix methods of system performance evaluation. Velocity measurements in a hot gas flow are difficult but the new optical techniques may offer practical possibilities. Intake system performance evaluations have already been undertaken [15] using wall pressure measurements and velocity measurements made with hot wires. In this case, though the temperature changes are relatively modest, they were large enough to introduce difficulties with the hot wire calibration and signal interpretation. Though much more expensive, optical techniques should be free of such difficulties.

4. DISCUSSION

The analysis and results presented here represent one approach to improving the understanding of the acoustic behaviour of exhaust and inlet system elements and how they interact. It has been shown that concepts

based on linear acoustic modelling are applicable to the control of intake and exhaust noise provided they are employed with an adequate understanding of their limitations. Current knowledge and practical experience confirms that linear acoustic modelling can define the relationships that govern the interactions between system elements and provide useful predictions of system performance. These facts have been appreciated by intake and exhaust system designers and manufacturers for some time, see for example references [4] and [5]. At the same time shortcomings with the approach have been experienced in cases where there has been a failure to achieve the predicted insertion loss by a substantial margin.

In reviewing progress in the study areas (a) to (f) listed in the introduction, it has become clear that successful application of linear plane wave acoustic techniques depends on

- 1) Taking due account of flow conditions, including temperature gradients.
- 2) Employing appropriate boundary conditions, including end corrections where required.
- 3) Recognising that the plane wave analysis is limited to those frequencies below which significant acoustic energy propagation can take place in higher order acoustic modes.
- 4) Appreciating the importance of correct packaging, in particular the measures needed to maintain linear acoustic behaviour in system elements and avoid excessive flow noise generation.
- 5) Taking care that pressure measurements are correctly performed, processed and interpreted.
- 6) Recognising that insertion loss not transmission loss is required for practical performance predictions.

In the light of all the existing evidence it appears unlikely that, with the pressure amplitudes normally experienced in intake or exhaust systems, any significant errors are introduced by employing linear acoustic theory for noise control analysis. Non-linear behaviour is however likely whenever uncontrolled flow separations occur, and also appears to be exhibited by system elements employing absorbing materials.

The two approaches to linear system analysis that have been discussed here are, in principle, equivalent to each other. The one described in

detail presents the analysis in terms of incident and reflected pressure waves or transmission line equations. (e.g. references [1], [2], [5], [7], [8], [9], [10], [11], [12], [15]). An alternative is to present the analysis in terms of transfer matrices relating to input and output particle velocities and pressures for each element (e.g. references [3], [4]). It is recognised that other methods of analysis (e.g. [14]), have also been developed which can provide useful alternative approaches for noise control analysis. These may be particularly relevant (e.g. finite element methods) for providing new insight into the acoustic behaviour of components for which linear acoustic analysis has so far proved inadequate. A valid criterion by which each of the methods may be judged is that they should be flexible and readily applicable to practical situations and must provide reliable predictions of acoustic performance.

Finally, an outstanding problem in the noise control analysis of engine intake and exhaust systems lies in characterising the source. Some results have been reported here, but these have been restricted to examples where the source characteristics appear to be independent of the acoustic load. There is clear evidence that many other examples exist where this is not the case. So that new developments in measurement and source analysis techniques are required to provide reliable noise control predictions in such situations.

REFERENCES

1. R.J. ALFREDSON and P.O.A.L. DAVIES 1970 *Journal Sound and Vibration* Vol.13, 389 - 408. The radiation of sound from an engine exhaust.
2. R.J. ALFREDSON and P.O.A.L. DAVIES 1971 *Journal Sound and Vibration* Vol.15, 175-197. Performance of exhaust silencer components.
3. M.L. MUNJAL 1975 *Journal Sound and Vibration*, Vol.39, 105 - 119. Velocity ratio-cum-transfer matrix method for the evaluation of a muffler with mean flow.
4. V.C. BYRNE and J.E. HART 1973 S.A.E. Paper No.730429. Systems approach for the control of intake and exhaust noise.
5. M. AMANO; S. KAJIYA; T. HAKAKUBO 1977 I.Mech.E., London Conference Paper No. C16/77. Performance predictions of 'silencers for the internal combustion engine.
6. H. LEVINE and J. SCHWINGER 1948 *J.Phys.Rev.* 73, 383. On the radiation of sound from an unflanged circular pipe.
7. E. MYER and E.G. Neumann 1972 *Physical Acoustics*, Chapter 11. (Academic Press).
8. P. MUNGER and G.M.L. GLADWELL 1969 *Journal Sound and Vibration*, Vol.9 28 - 48. Acoustic wave propagation in a sheared fluid in a duct.
9. P.O.A.L. DAVIES 1973 *Proc.I.M.A.S.*, London, Section 4, 59 - 61. Exhaust system silencing.
10. A.J. CUMMINGS 1975 *Journal Sound and Vibration*, Vol.38, 149 - 155. Sound transmission at sudden area expansions in circular ducts with superimposed mean flow.
11. W.J. ADAMS 1975 I.S.V.R. Internal and Contract Reports, University of Southampton.
12. A.J. CUMMINGS 1975 *Journal of Sound and Vibration*, Vol.41, 375 - 379. Sound transmission in a folded annular duct.
13. C.J. MOORE 1977 *Journal Fluid Mech.* Vol.80, 321 - 368. The role of shear layer instability waves in jet exhaust noise.
14. S.W. COATES and G.P. BLAIR 1974 S.A.E. Trans.84, 740173. Further studies of noise characteristics of internal combustion engines.
15. A.T. HARCUMBE 1977 University of Southampton Honours Thesis. A study of pressure waves in the intake duct of an internal combustion engine using acoustic methods.

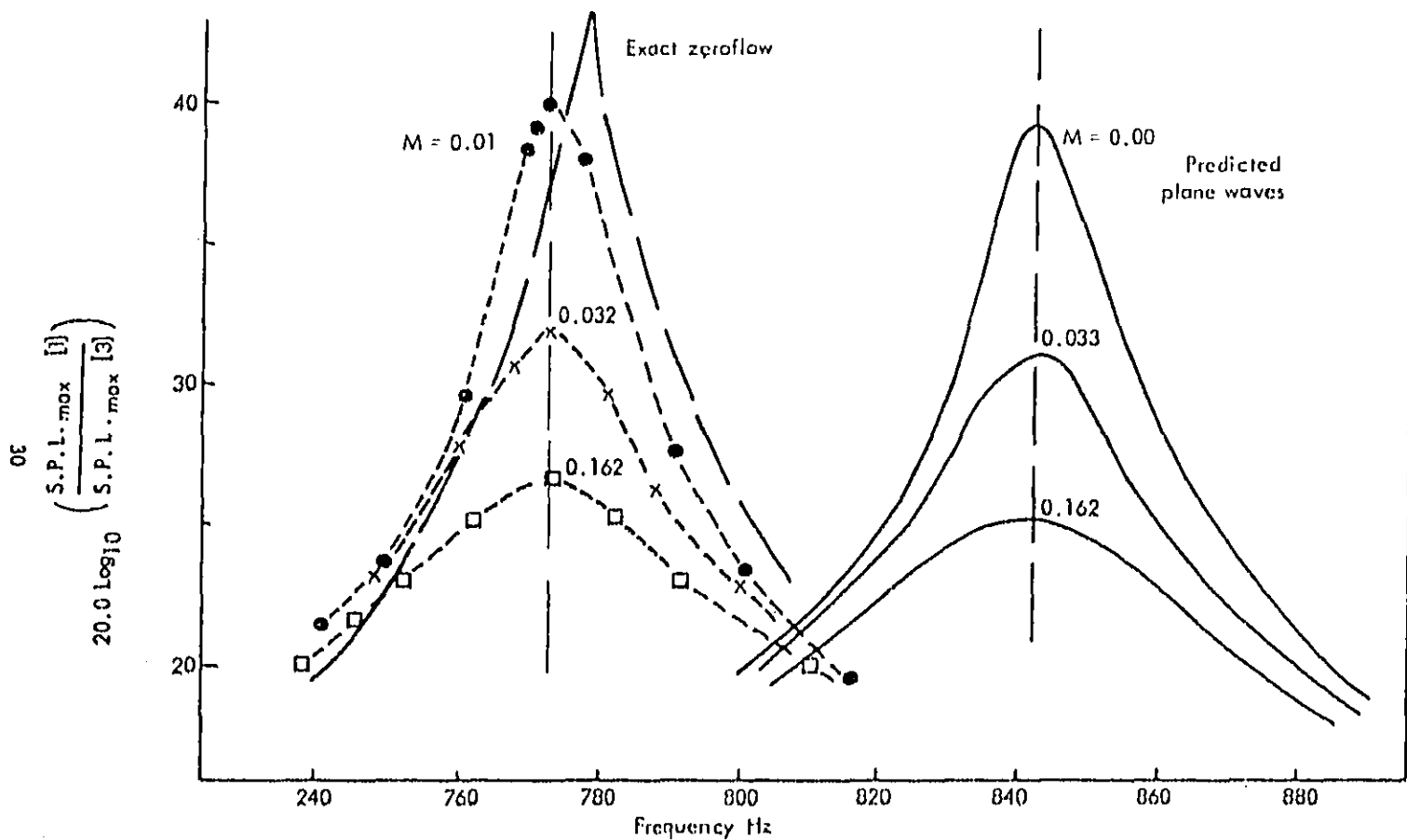

FIG. 1a. ACOUSTIC ENERGY TRANSPORT AT A CONTRACTION WITH SIDEBRANCH.

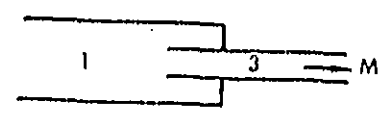
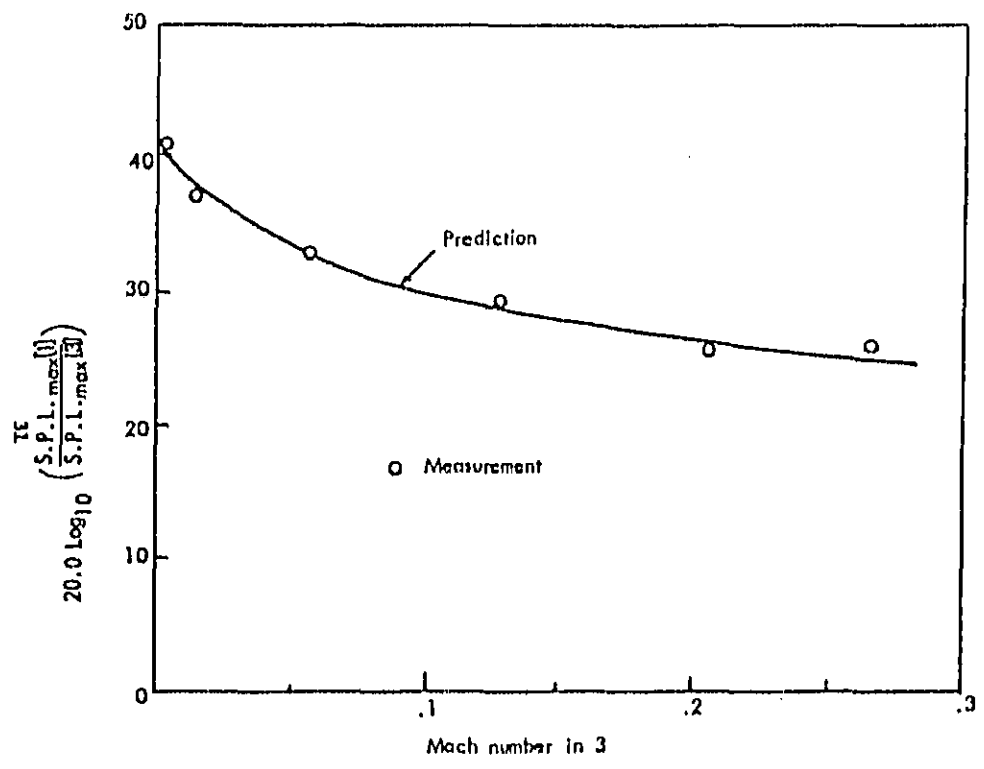

FIG. 1(b) ACOUSTIC ENERGY TRANSPORT AT A CONTRACTION WITH SIDEBRANCH.

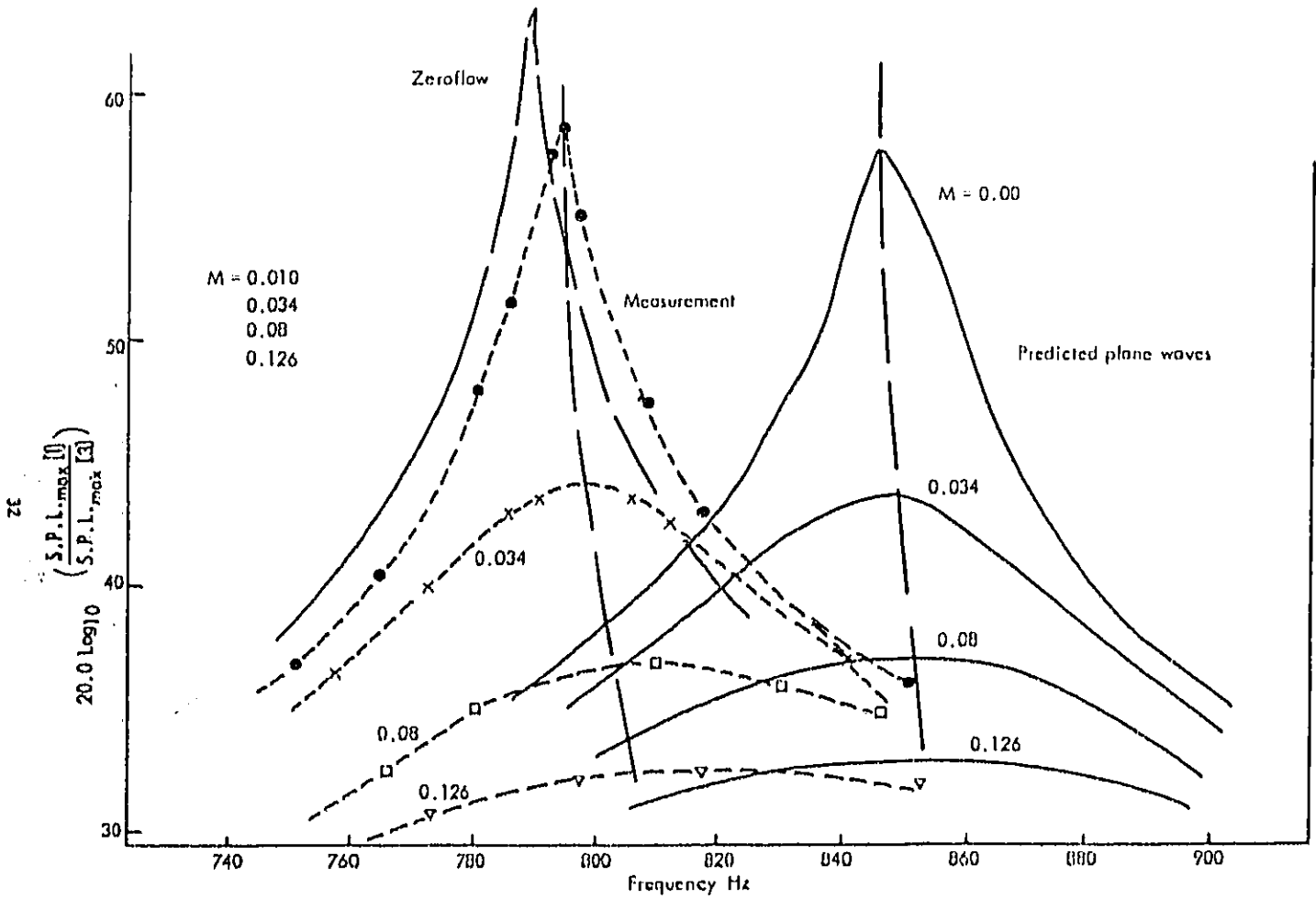

FIG. 2a.

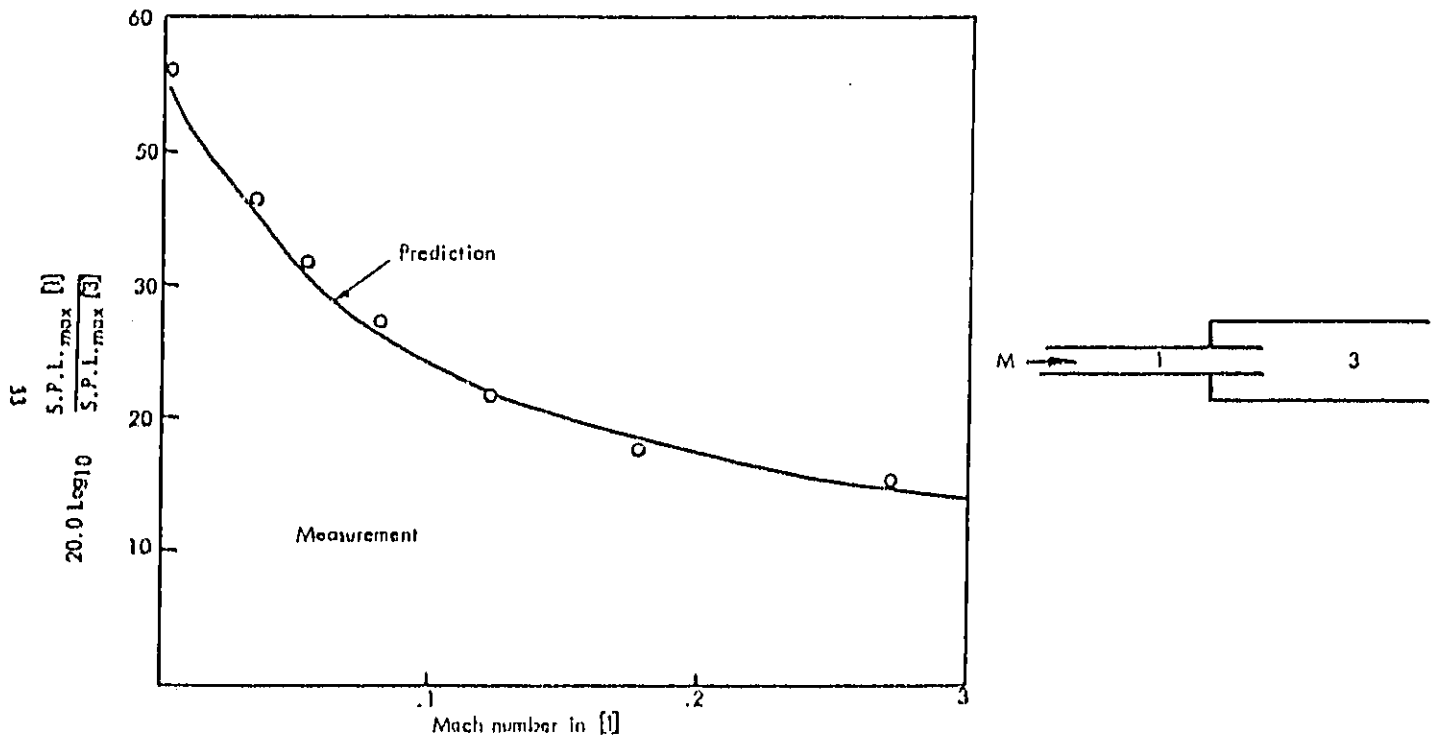

FIG. 2(b). ACOUSTIC ENERGY TRANSPORT AT AN EXPANSION WITH SIDE BRANCH

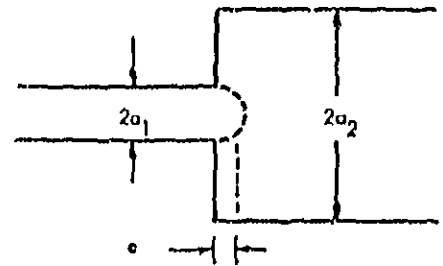
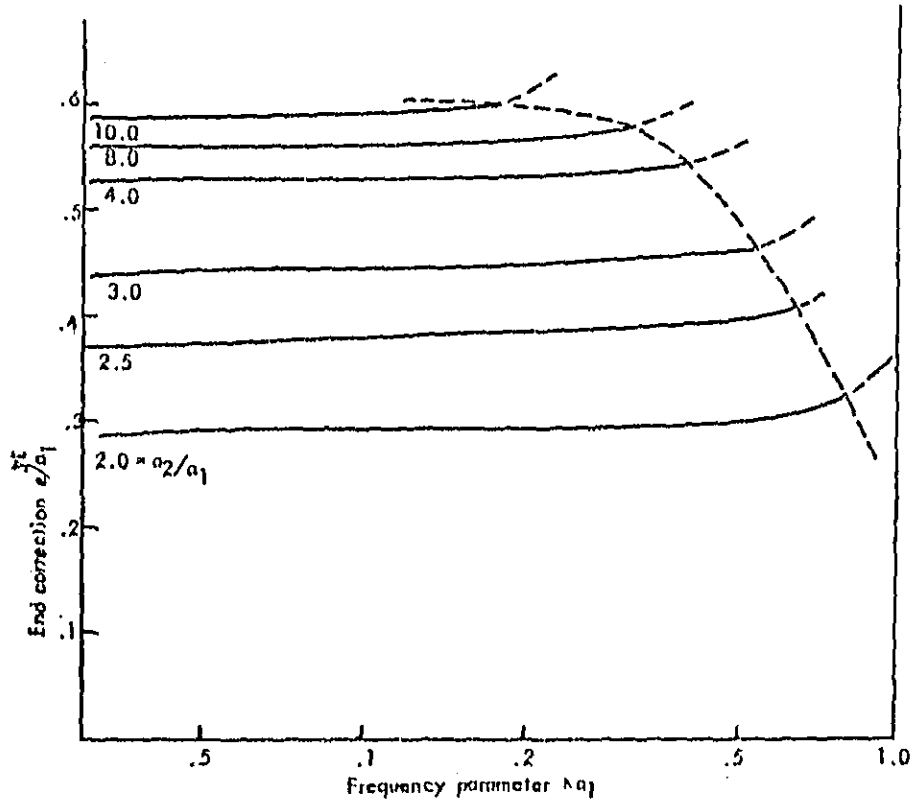
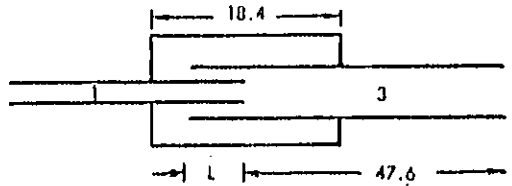
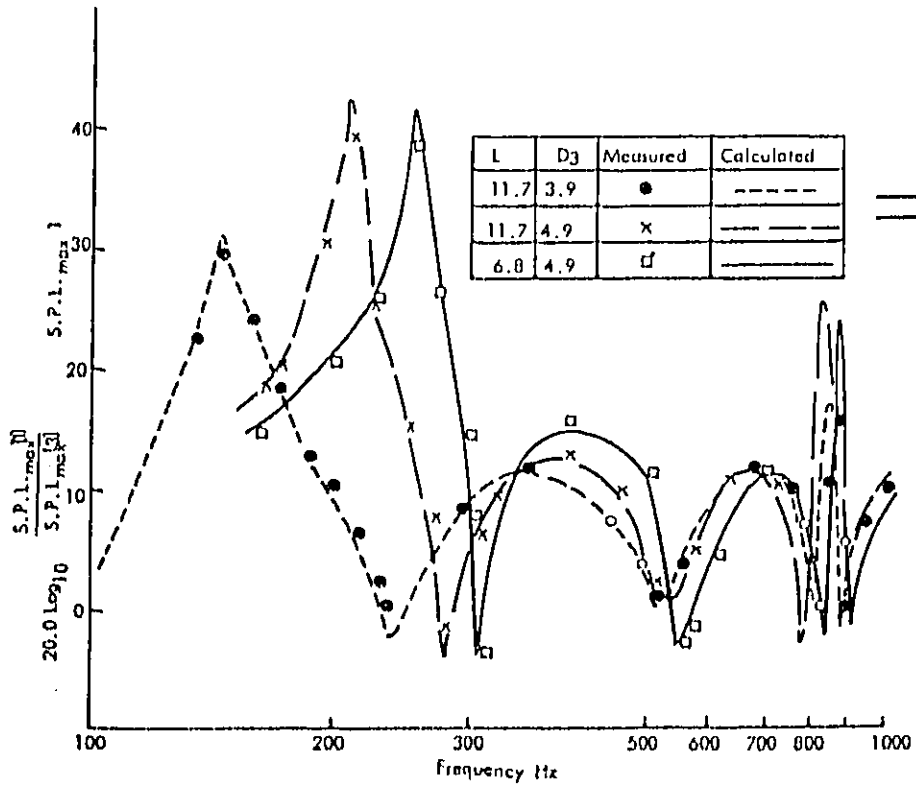

FIG. 3. END CORRECTION FOR EXPANSION OR CONTRACTION.



- D₁ = 2.54
- D₂ = 2.85
- D₄ = 5.1
- D₅ = 7.55

FIG. 4. PERFORMANCE OF FOLDED CHAMBERS.

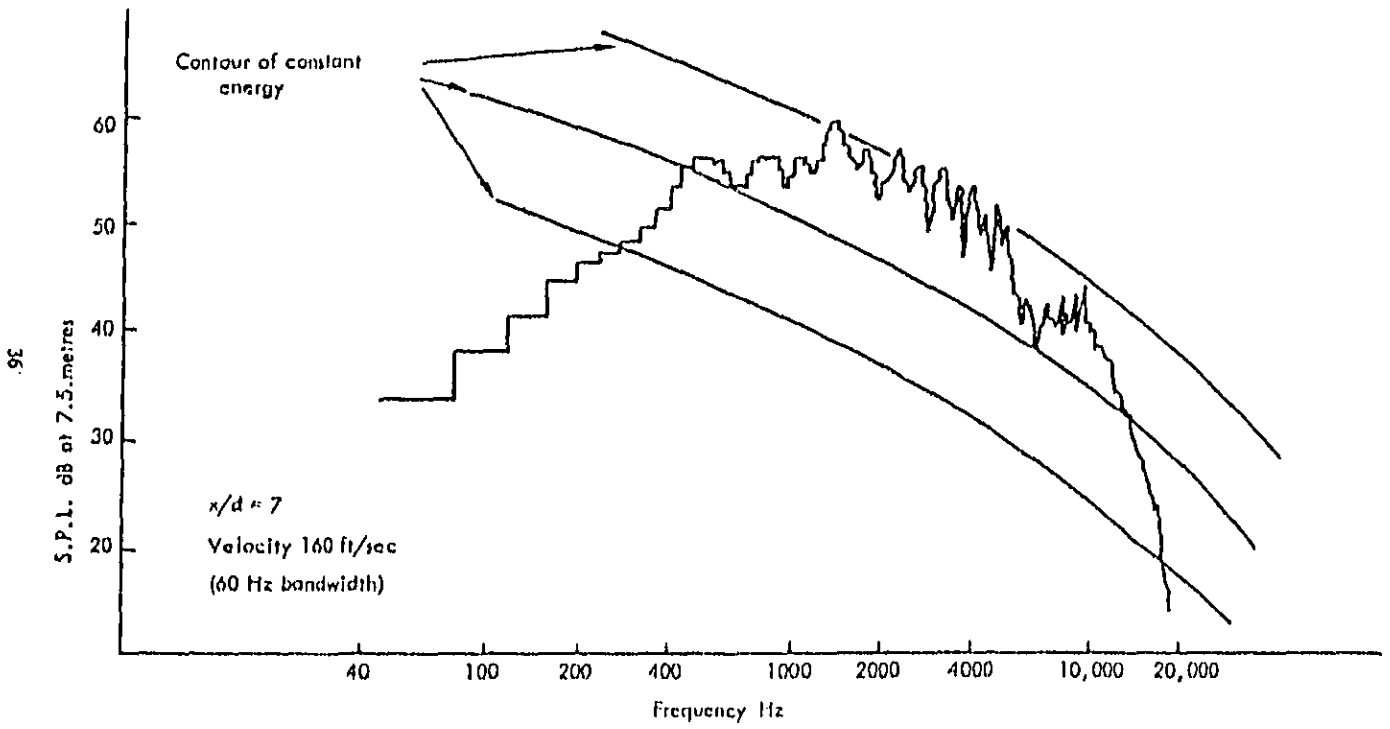

FIG. 5. SPECTRAL CONTENT OF FLOW NOISE

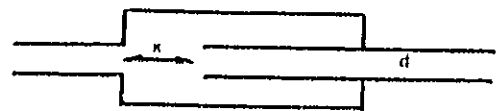
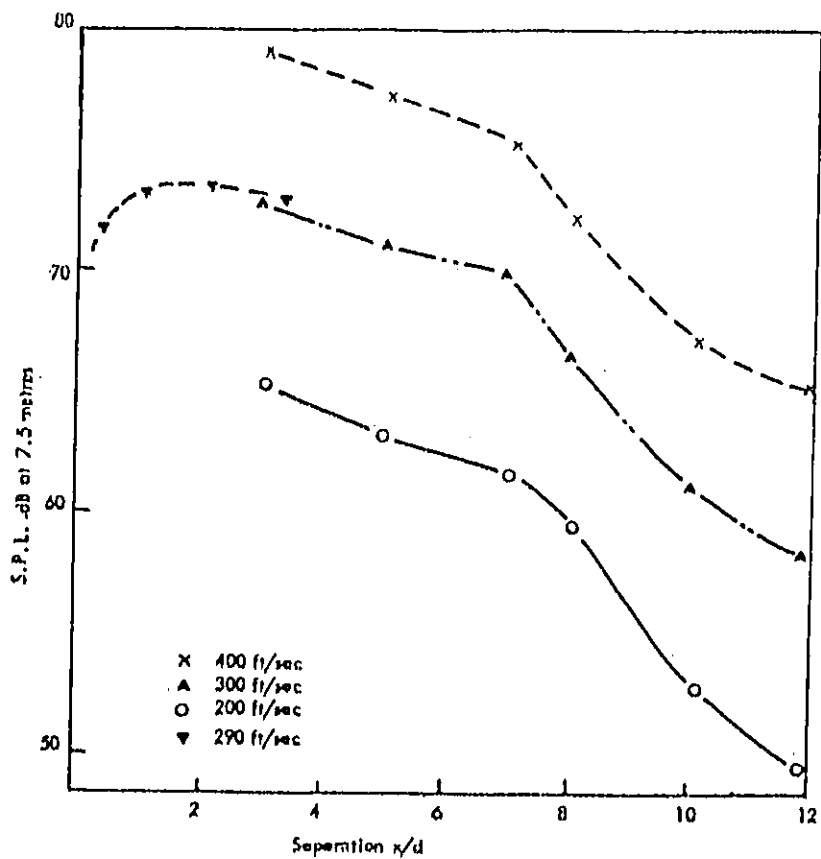

FIG. 6. FLOW NOISE GENERATION IN AXIAL CHAMBERS.

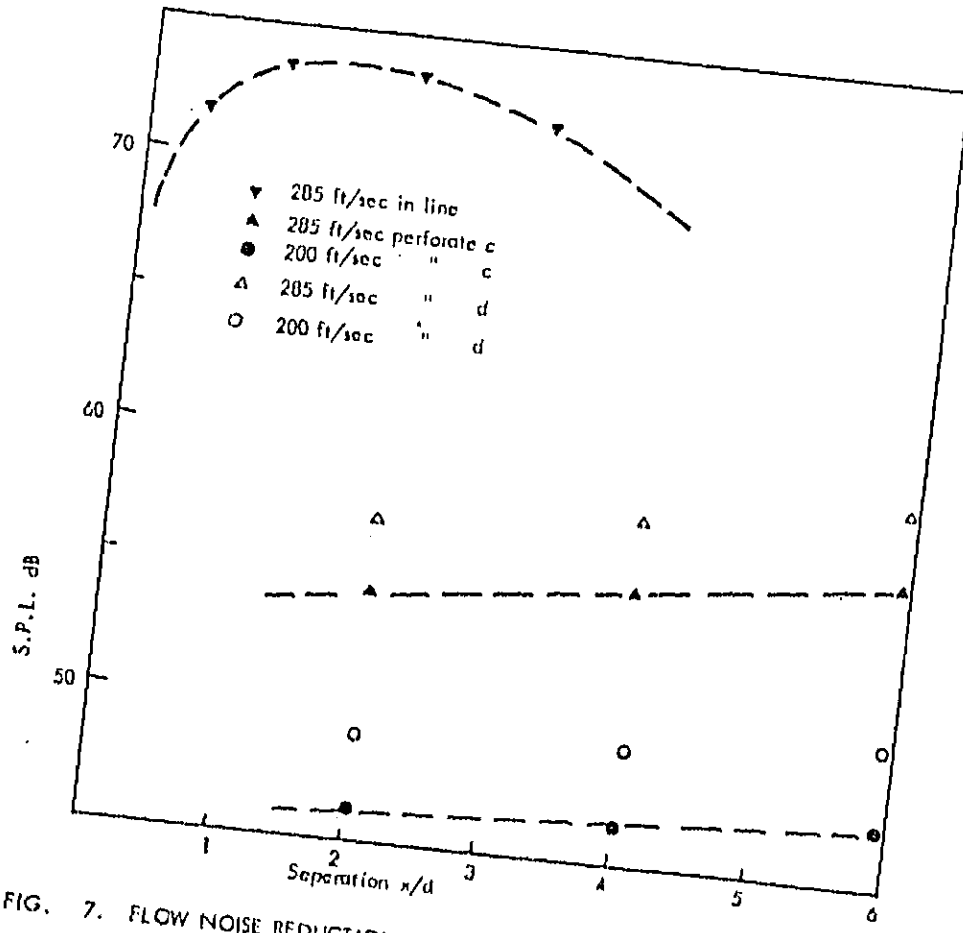

FIG. 7. FLOW NOISE REDUCTION BY PERFORATES.

REF ID: A61111

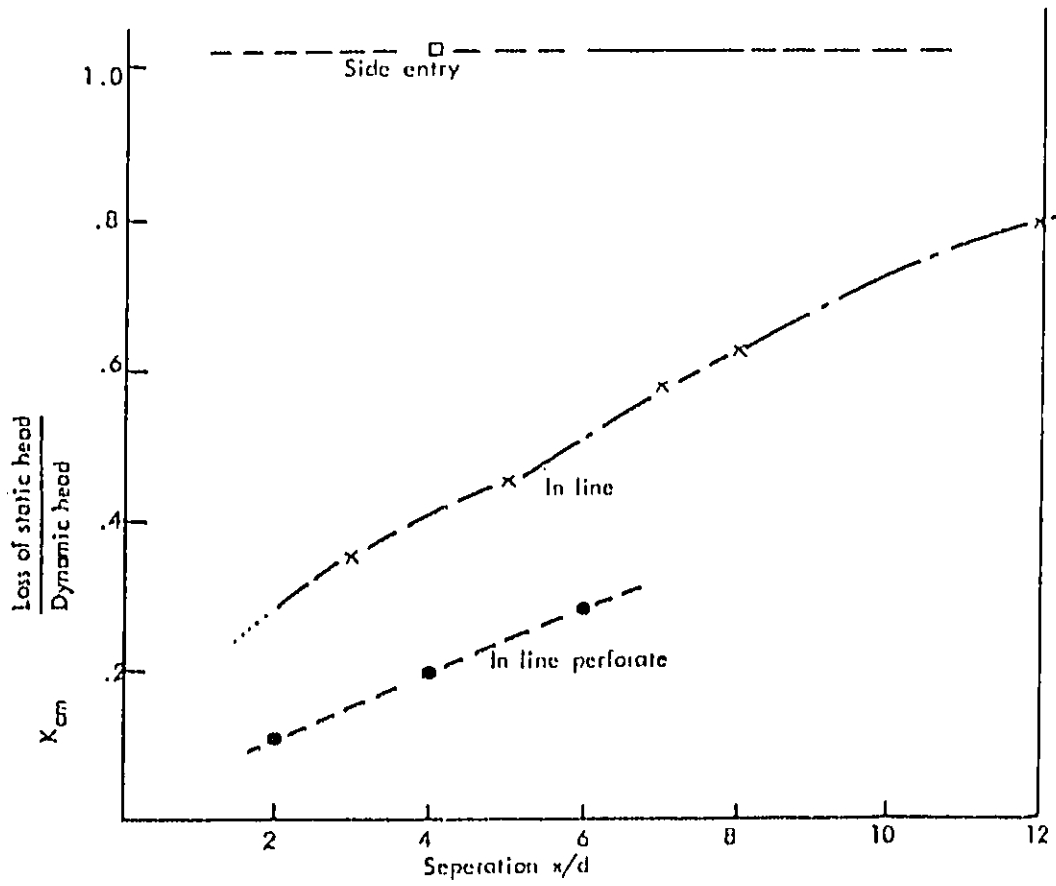

FIG. 8. BACK PRESSURE OF EXPANSION CHAMBERS.

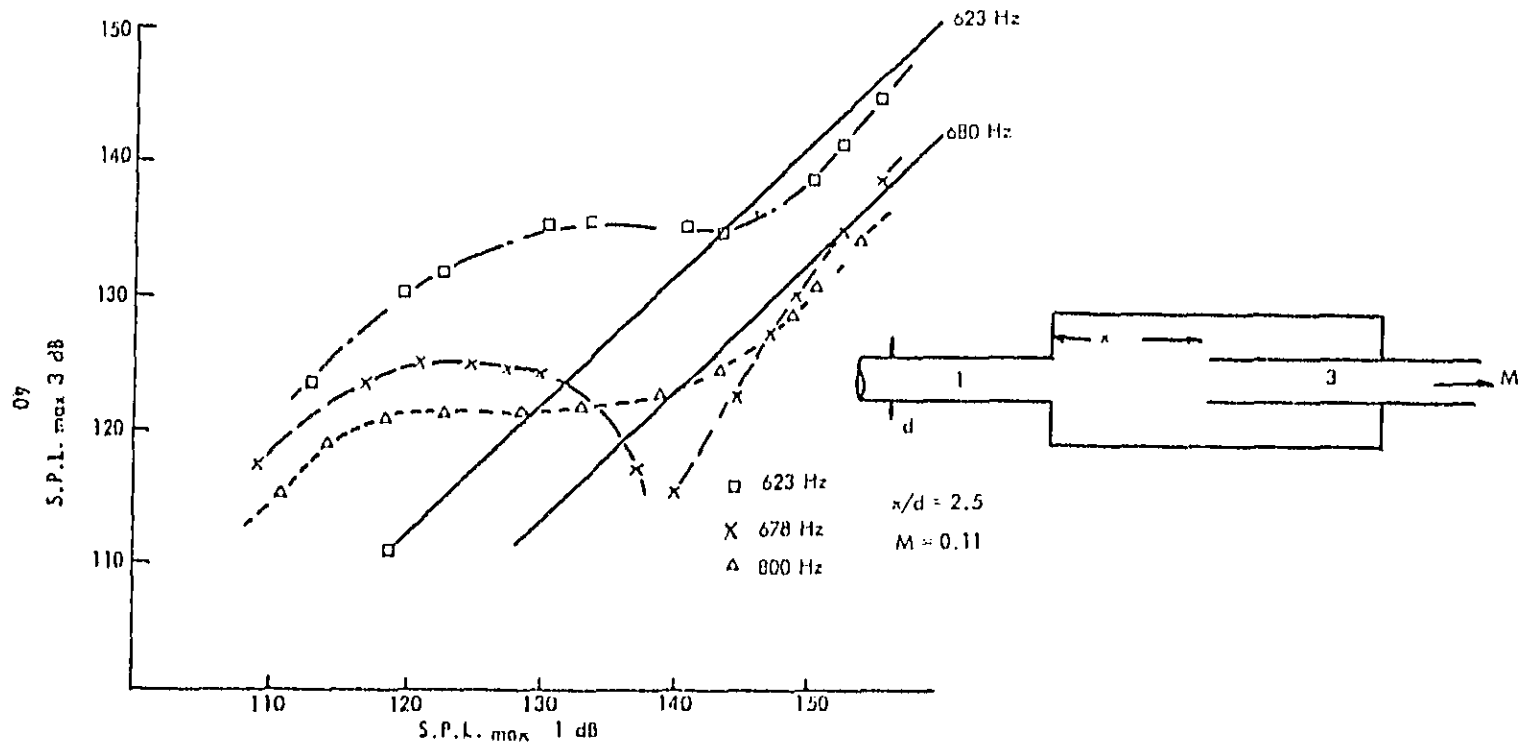

FIG. 9. FLOW ACOUSTIC COUPLING AT AN AREA EXPANSION.

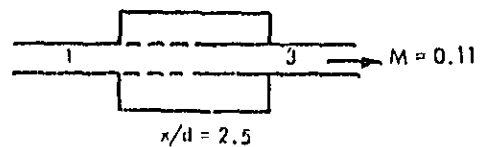
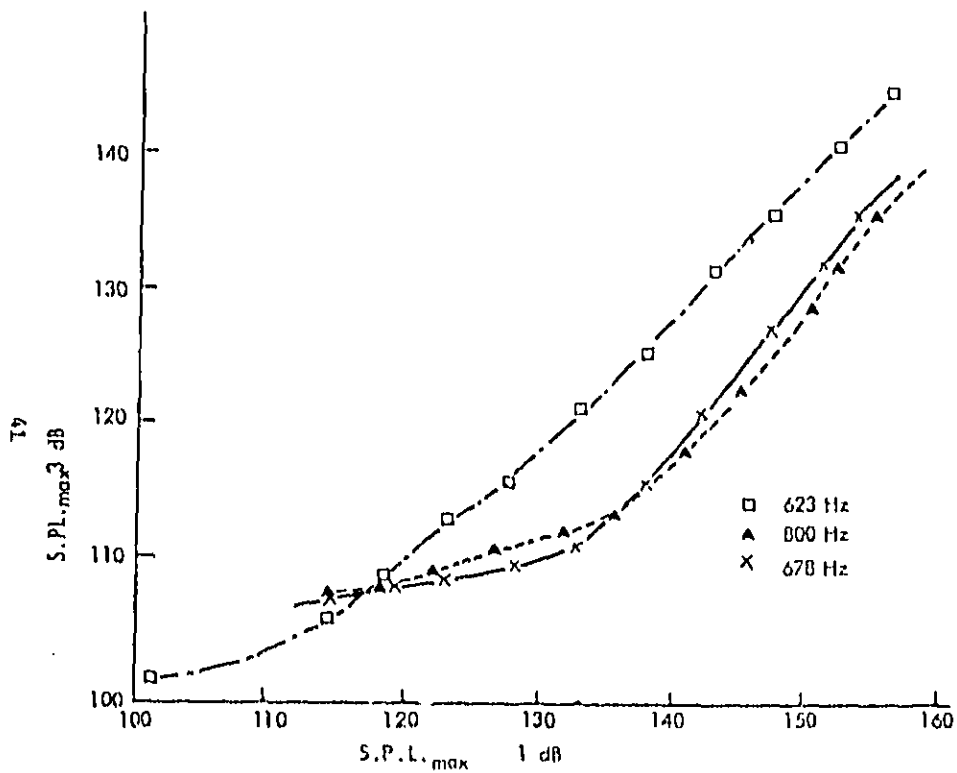

FIG. 10. SUPPRESSION OF FLOW-ACOUSTIC COUPLING BY A BRIDGE PERFORATE.

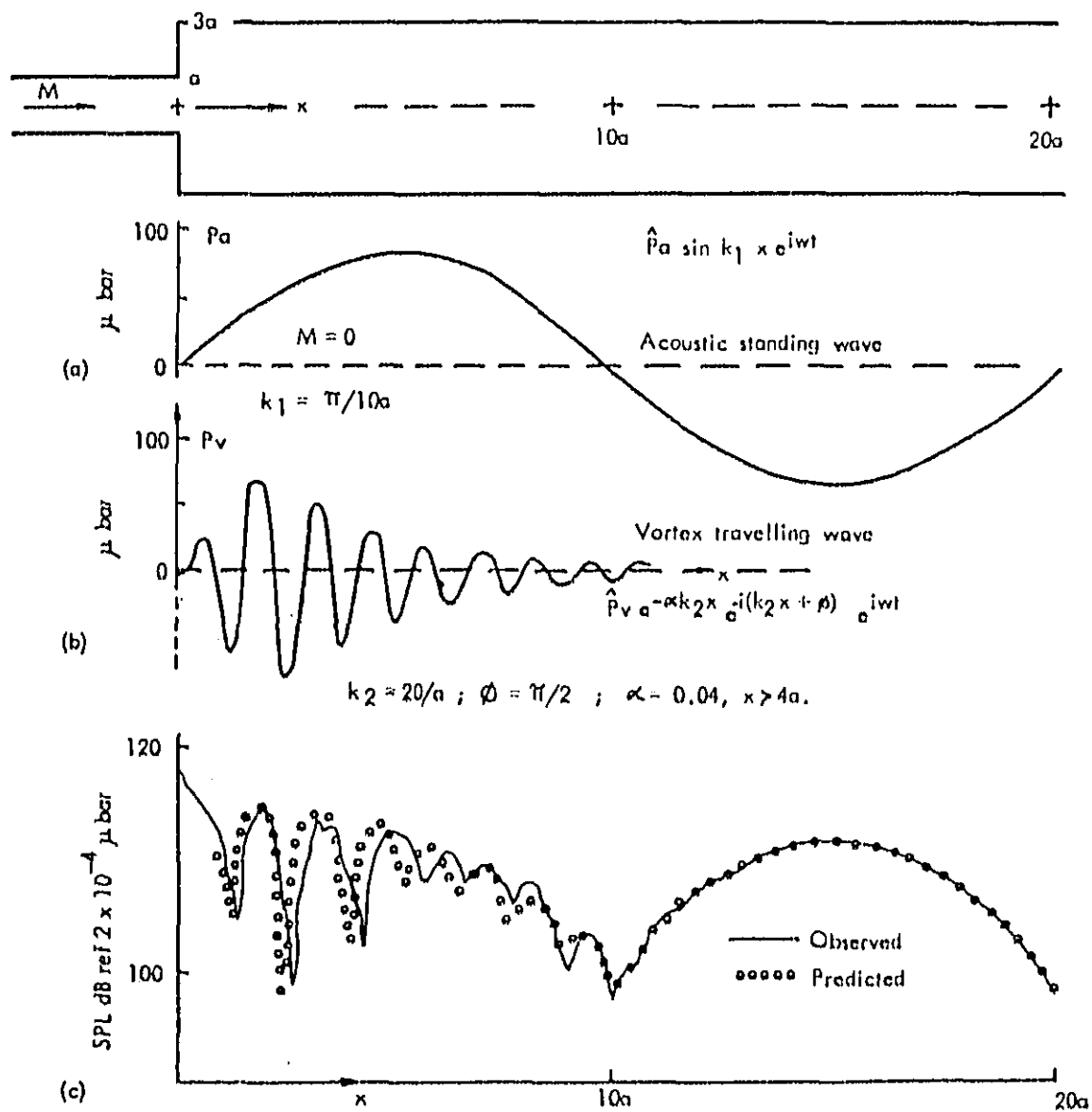

FIG. 11 SOUND PRESSURE LEVEL AFTER A DUCT EXPANSION $M = 0.1$; $f = 1250\text{Hz}$
 $2a = 25\text{mm}$; $U_c = 0.63 M c_0$

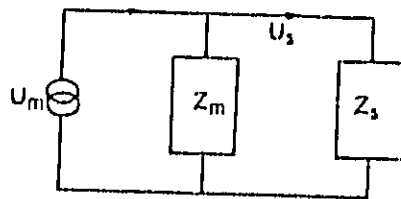

Figure 12

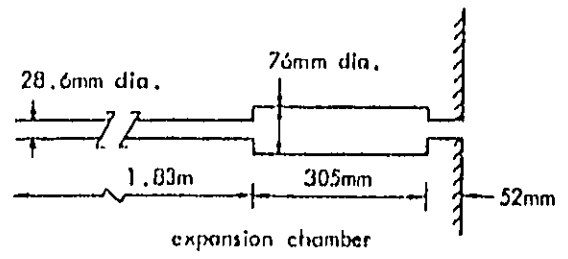
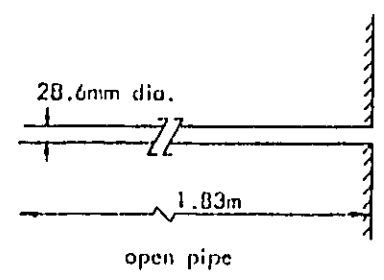
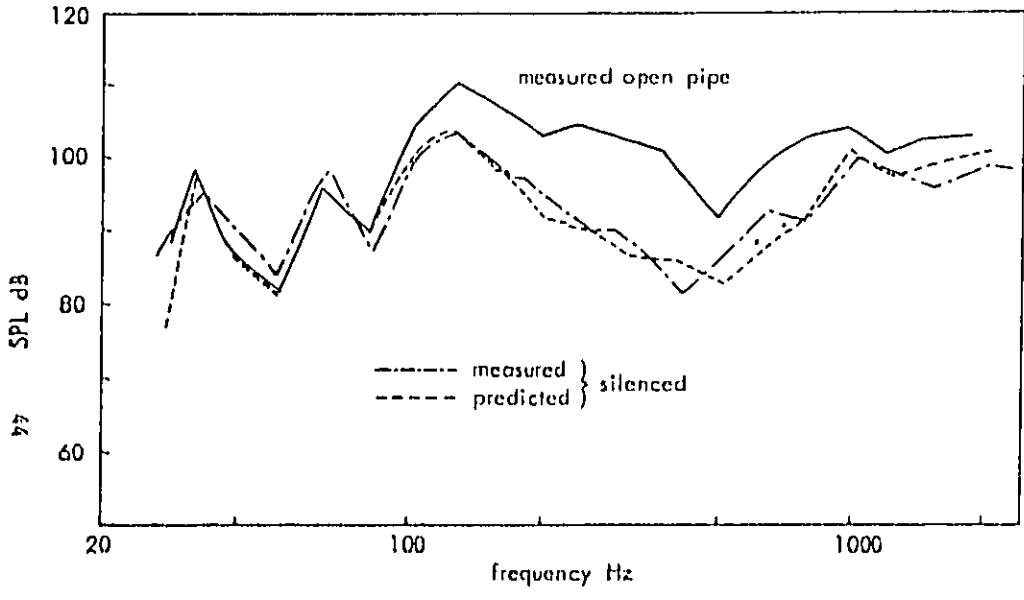

FIG. 13 SINGLE EXPANSION CHAMBER PERFORMANCE CONSTANT VOLUME VELOCITY SOURCE LINEAR ACOUSTIC ANALYSIS

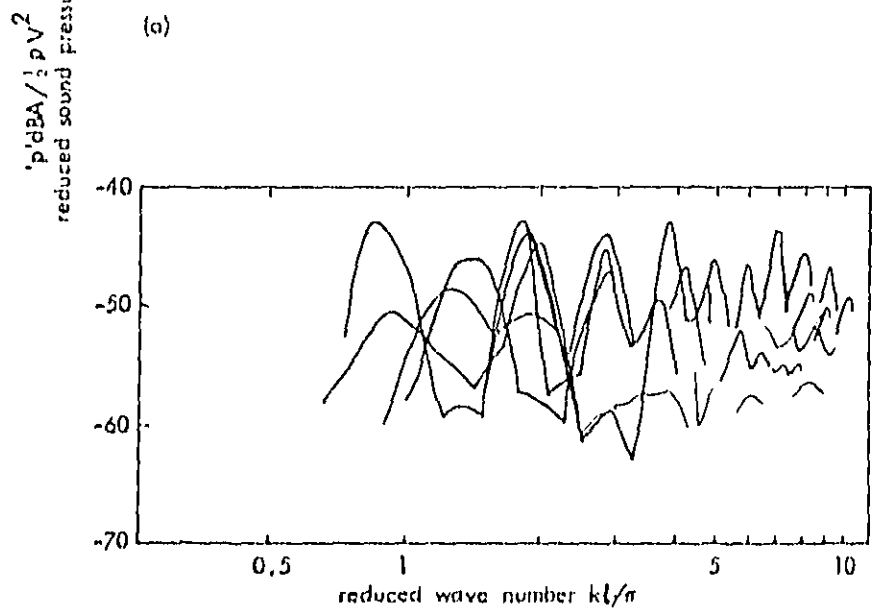
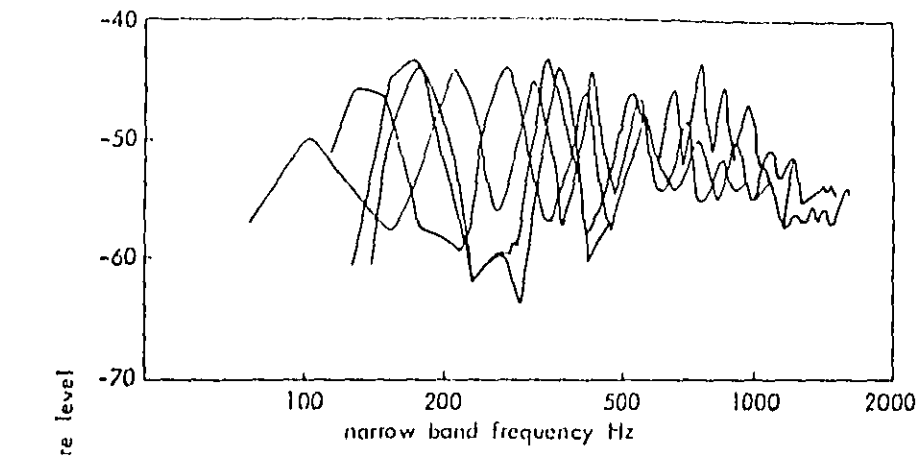

FIG. 14 OPEN PIPE MEASUREMENTS, FULL LOAD,
 FOUR CYLINDER FOUR CYCLE PETROL ENGINE,
 $2000 < N < 5250$ rpm

DCEP AVIATION SERVICES

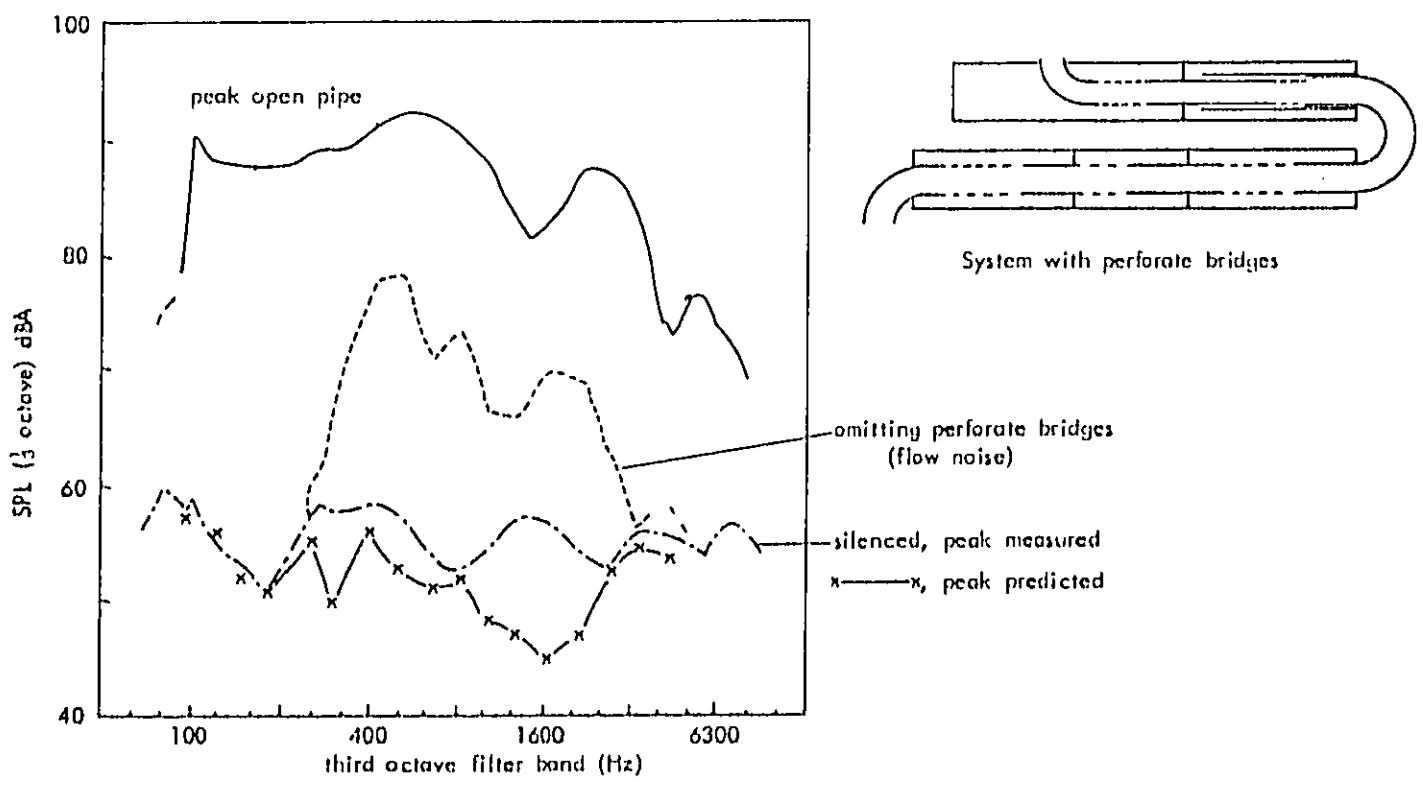

FIG. 15 AVERAGED MEASURED PERFORMANCE. TURBOCHARGED DIESEL AT 7.5m
FULL LOAD 8 SPEEDS 1000 < N < 2350

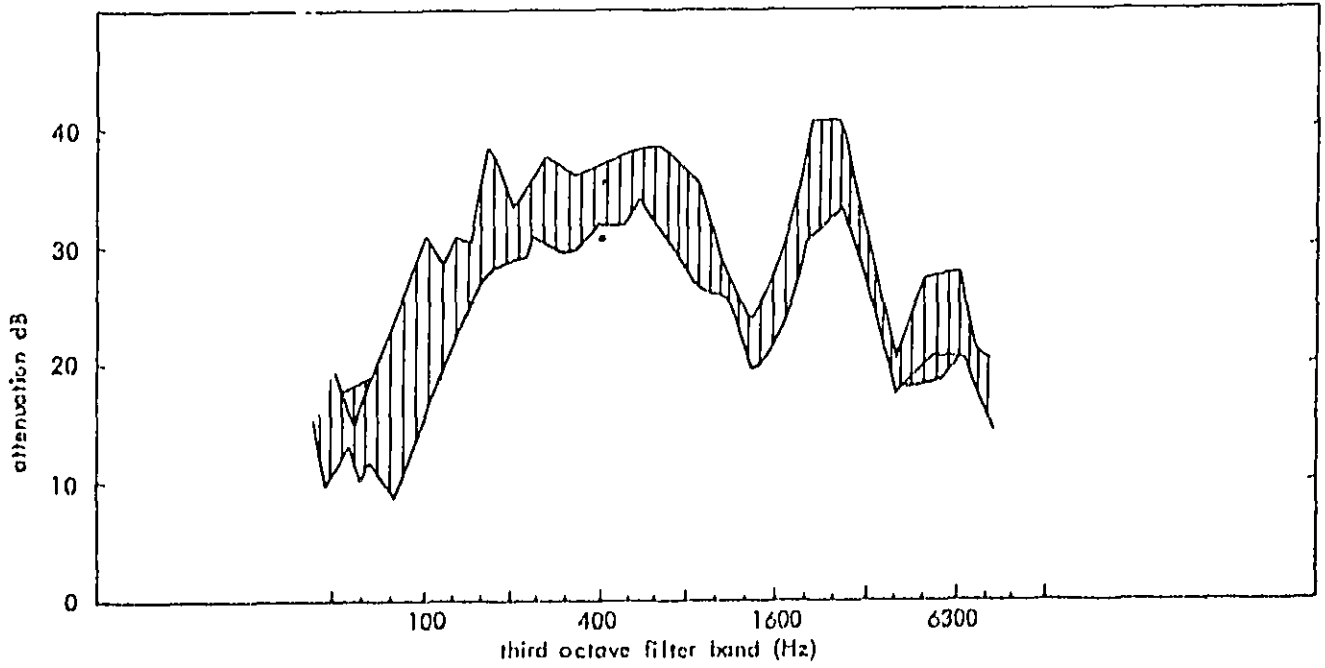

FIG. 16 AVERAGE MEASURED INSERTION LOSS, FULL LOAD TORQUE & SPEEDS, $1000 < N < 2350$ rpm. Hatching indicates range of variation.

AUTOMOTIVE EXHAUST SYSTEM EVALUATION

by

D. A. Blaser, J. Y. Chung, and R. Hickling
Fluid Dynamics Research Department
General Motors Research Laboratories
Warren, Michigan 48090

To be presented to:

Surface Transportation Exhaust System Noise Symposium
Sponsored by the U.S. Environmental Protection Agency
and
Conducted by the Environmental Protection Agency and
McDonnell Douglas Astronautics Company at Chicago, Illinois

To be published in:

Proceedings of Symposium

ABSTRACT

The results of several exhaust noise studies that have been performed at the General Motors Research Laboratories are presented. The principal contribution is a new transfer-function method of measuring the acoustic characteristics of exhaust systems with flow. The method appears to provide, for the first time, a means of making routine test measurements over the frequency range of interest without being too time consuming and without the need to use a computer system other than a laboratory type analyzer. Other results presented in this paper relate the acoustical pressure in the tail pipe to the radiated sound and indicate how exhaust noise is determined by engine type and operating condition.

INTRODUCTION

A few years ago, a program of exhaust noise research was initiated at the GM Research Laboratories that had as its goal an increased understanding of exhaust system performance and of the mechanisms of noise generation in exhaust systems. At the outset of the program it became apparent that, although the acoustical theory of silencer elements such as expansion chambers, resonators and acoustically-absorbing linings was reasonably well understood, the effect of gas flow, temperature, high-amplitude waves and other important features of real exhaust systems was not. Also, it seemed that there was little basic experimental information on exhaust system noise and that suitable test methods were lacking. It was decided, therefore, to concentrate initially on experimental tests and test methodology before proceeding to theoretical models and design methods.

This paper presents some of the results of this work. Several topics are covered. First there is a short discussion of exhaust system noise as determined by engine type and operating condition. Next some data are presented on noise as it is radiated from the tail pipe. Finally a new transfer function method of measuring the acoustic characteristics of exhaust systems (such as reflection coefficients and transmission losses) is described.

ENGINE EXHAUST SYSTEMS

Exhaust noise is determined by a complete system comprising the engine and various exhaust components such as shown in Figure 1 which depicts a typical automotive exhaust system. The components shown in Figure 1 include the manifold, downpipes, catalytic converter, silencers, resonators and tail pipes. Exhaust system noise comprises tail pipe-radiated noise and shell-radiated noise from the structural vibrations of the various components of the exhaust. Both aspects have to be considered since occasionally they are comparable in magnitude.

Exhaust noise is caused by the pressure pulsations emanating from the exhaust valves of the engine. These pulsations are affected by the configuration and the mode of operation of the valves as well as by the operating condition of the engine. To a great extent the pulsations, which can typically be of the order of 175 dB, are reflected back from the silencer and resonator so that they are retained within the exhaust system and attenuated through various dissipative mechanisms. Typically the pulsations are reduced by about 20 dB at the downstream side of the silencer and resonator. These pulsations interact with the structure of the exhaust system and usually are the primary cause of the shell-radiated noise from the system.

Various types and sizes of engines are used to power ground transportation vehicles, ranging from small 4-cylinder spark ignition engines for compact cars to large 20-cylinder Diesel engines for locomotives. Although the exhaust system requirements may vary considerably over this range of vehicles, the noise generated at the exhaust ports of the various engines have several features in common.

Figure 2 presents unsilenced exhaust noise data for a V-8 spark ignition engine and an BV-71 Diesel engine. Although the load and speed conditions are not the same, both engines exhibit tonal noise below 1 kHz composed of harmonics of the engine firing frequency, and broadband noise above 1 kHz composed primarily of flow noise generated during the initial opening of the exhaust valve. Since all engines create exhaust noise spectra similar to those appearing in Figure 2, design of engine exhaust systems would appear to be a relatively straightforward task. However, complexities are introduced by stringent space limitations in a vehicle, the extensive range of operating conditions over which the designer has to limit the noise, and the back-pressure requirements which are different for different engines. A diesel engine operates unthrottled continuously and, hence, the back pressure at part load has a greater effect on engine performance than in a spark ignition engine which is throttled at part load. A Diesel-engine exhaust system must, therefore, in general be designed to have a smaller back pressure.

The effect of engine operating conditions on A-weighted exhaust noise is shown in Figure 3. These data represent noise radiated from the tail pipe of an unsilenced V-8 spark-ignition engine throughout its complete range of operation. Although exhaust noise is known to increase in level with increasing engine speed and with increasing load, these data show that the level of exhaust noise is governed principally by the exhaust gas mass flow rate. This is not too surprising since pressure pulsations are created by the exhaust gas blow-down process during exhaust valve opening. It is recognized that other engine parameters such as exhaust valve timing and cam shape, exhaust manifolding, etc., can also affect exhaust noise; however, once the engine is designed these parameters are fixed, thus the exhaust noise level is set by the exhaust gas mass flow rate.

TAIL PIPE

The tail pipe opening plays an important role in the acoustic performance of the engine exhaust system since it is at the tail pipe that a major portion of the acoustic energy of the exhaust pressure pulses is radiated as sound. There was considerable confusion concerning the details of this radiation process until 1948, when Levine and Schwinger [1]* developed the theory of the reflected wave from an unflanged circular pipe without flow. Since then, several experimental studies have been performed to determine the effect of flow on the reflection process [2,3]. In this more recent work the most significant result is probably that obtained by Alfredson and Davies [2] who, by assuming monopole radiation from the pipe (i.e. equating the energy of the plane wave in the pipe to the energy in the spherical spreading wave outside the pipe), developed the following relation between the amplitude of the pressure p_i of the plane wave inside the pipe to the spherical wave pressure p_o outside the pipe,

* Numbers in brackets [] refer to References at the end of the report.

$$\begin{aligned}
 \Delta L = 20 \log \frac{|p_1|}{|p_0|} &= 20 \log \left(\frac{2r}{d} \right) + 10 \log \frac{(pc)_1}{(pc)_0} \\
 &- 10 \log [(1+M)^2 - R^2 (1-M)^2] \quad (1)
 \end{aligned}$$

where r is the radial distance from the end of the pipe, d is the pipe diameter, $(pc)_1$ and $(pc)_0$ are the characteristic impedances inside and outside the pipe, respectively, M is the Mach number of the flow in the pipe and R is the tail pipe reflection coefficient. The three terms in equation (1) represent the effects of area divergence, fluid properties or temperature, and acoustic energy reflection and convection, respectively on the radiation of sound from the tail pipe. Apart from a few experiments in the original paper by Alfredson and Davlen [2], little or no data has appeared in the literature to confirm the validity of this equation. However, it appears to be a useful formulation and it has been used in investigations at the GM Research Labs to study the un-attenuated radiation of acoustic energy from the tail pipes of different engine exhaust systems. Some of these data are discussed here.

Narrow band spectra of the exhaust noise radiated from the pipe compared with similar spectra for pressures at two locations within the pipe, one close to the end and the other 1.385 m upstream, are shown in Figure 4. Far up the pipe, the spectrum is seen to be dominated by low-frequency energy composed primarily of harmonics of the engine firing frequency. Near the end of the pipe and in the outside noise, the dominance at lower frequencies is somewhat reduced. Reflection at the end of the tail pipe and the nature of the radiation process in the external sound field are responsible for this change.

An interesting observation from Figure 4 is that the shape of the spectrum near the end of the tail pipe is very similar to that of the radiated noise exterior to the pipe, the noise spectrum being about 63 dB lower. From these data it would seem, therefore, that it might be possible to determine exterior noise levels from a measurement of the pressure near the end of the tail pipe. Such a single measurement does not separate the incident and reflected waves near the end of the pipe and hence does not provide the information needed to evaluate all the terms in Equation 1 precisely. However, the equation can be used to examine the dB difference observed in Figure 4. The pipe diameter was about 50 mm so that the area divergence effect is about 36 dB which accounts for most of the difference in level. The temperature effect is about -2 dB which leaves a net of 9 dB for the reflection and flow effects. It is not clear at present why this combination of effects should appear to be uniform across the frequency range of the data.

The directivity of the noise radiated from the tail pipe is important in addition to the level and frequency content. A typical directivity plot is shown in Figure 5 for an unattenuated engine. Engine noise was separated from exhaust noise by passing the exhaust pipe into an acoustically-lined room where the radiated sound pressure was measured 1.5 m from the tail pipe outlet. The linear sound pressure is fairly uniform due to the dominance of low frequencies as shown in Figure 4. A-weighting of the sound pressure, which gives an approximate measure of the loudness of the exhaust, gives a rather interesting pattern to the directivity. A quiet region occurs on the axis of the tail pipe, with the loudest noise radiated 40° to 60° off the axis. It is believed that refraction of acoustic waves by the velocity and temperature gradients in the region of the exhaust-gas jet is responsible for this variation in directivity.

Only frequencies for which the wave length is smaller than the jet region will be strongly refracted, thus, low frequency sound is radiated rather uniformly while high frequency sound is directed off the tail pipe axis. This frequency splitting effect is illustrated by the frequency spectra in Figure 6. Below 1 kHz the two spectra are very similar; however, above this frequency, the sound pressure is nearly 10 dB higher off the tail pipe axis (at 45°) than on the axis (at 0°). Since A-weighting makes the level more sensitive to higher frequencies, the A-weighted sound pressure level of Figure 5 reflects this shift of high frequency sound off the tail pipe axis while the linear level does not.

Radiation directivity patterns similar to the laboratory measurements of Figure 5 have also been observed in noise tests of vehicles. For example, the directivity of sound measured 15 m (50') from the rear of a transit coach is shown in Figure 7. Although these latter data also contain directivity peaks due to other sources of noise (such as engine block noise, fan noise, etc.), the quiet region at the rear of the coach and the secondary directivity lobes at 145° are essentially caused by refraction of the noise radiated from the tail pipe opening.

A TRANSFER-FUNCTION TECHNIQUE FOR MEASURING THE ACOUSTIC CHARACTERISTICS OF EXHAUST SYSTEMS WITH FLOW

For exhaust systems, it is important to have an efficient method of measuring normal incidence acoustic properties, such as reflection coefficients, transmission coefficients, acoustic impedances and transmission losses. The sound has to be separated into incident and reflected components and this can be a relatively difficult problem when the sound is being generated continuously and standing waves are being formed in the exhaust system. Once the separation has been achieved, however, into so-called right-running and left-running waves, as depicted in Figure 8, all of the normal-incidence acoustic properties in an exhaust system can be determined.

The classical method of decomposing standing wave systems in ducts is the standing-wave-ratio (SWR) method [4] in which a small microphone or microphone probe is moved axially along the duct to measure the amplitude and location of the acoustic pressure maxima and minima. From this information, the reflection coefficient can be determined. The SWR method has several disadvantages:

- a. The method requires acoustic excitation of the duct system at discrete frequencies and, hence, is time consuming.
- b. The microphone position must be known quite accurately to resolve the phase of the reflected wave. This causes difficulty at high frequencies.
- c. The microphone must be moved at least a half-wavelength at each frequency so that the microphone system has to be quite cumbersome in order to make measurements at lower frequencies.
- d. Measurements that have to be made within a long duct section are affected by dissipation at the duct walls.

- e. When there is flow in the duct, the flow noise generated by the microphone system can completely mask the acoustic waves being measured.

These disadvantages virtually eliminate the SWR method as a practical tool for the routine testing of exhaust systems with flow.

Other less-cumbersome methods of separating incident and reflected waves have been tried to avoid some of the difficulties just cited. A direct separation of incident and reflected sound can be achieved with the use of broadband short-duration excitation pulses in a relatively long section of duct [5,6]. Because of the length of duct needed, dissipation problems occur at the walls as mentioned in (d.) above. Also there is difficulty in creating sufficient high-frequency content in the short-duration pulses to overcome flow and/or background noise in the upper frequency range. Another method of separating incident and reflected sound uses correlation techniques with a discrete frequency excitation [7]. Two wall-mounted microphones measure the standing-wave amplitude and phase relative to a common reference voltage and the cross-correlation between these measurements is used to decompose the standing wave into incident and reflected waves. Although the wall-mounted microphones reduce flow noise, the method is essentially as time consuming as the SWR method.

A broadband method is to be preferred, therefore, for practical testing since, in general, discrete frequency methods appear to be too time consuming. As we have seen, short pulses do not seem to work too well for broadband excitation in a duct. This leaves random-noise excitation. Random-noise excitation methods are now widely used in conjunction with Fourier analysis equipment, particularly in vibration analysis, and it would obviously be beneficial if such powerful procedures could be applied to exhaust noise testing. During the past two years, a practical transfer-function technique of this kind has, in fact, been developed at the GM Research Laboratories for acoustic measurements in duct systems with flow. We would like to present here a derivation of the method together with test data relative to some known no-flow theoretical solutions. It should be noted that this is not the only random-noise technique that has been proposed for exhaust-noise testing. Seybert and Ross recently proposed such a method [8]. However their procedure involves a mathematical formulation, based on auto- and cross-spectra, rather than transfer functions, that cannot easily be used in practical testing. The transfer-function method that we describe here can provide an instantaneous readout of quantities such as reflection coefficients and transmission losses over a reasonably broad frequency range using a two-channel laboratory analyzer.

Theory

Referring to the schematic diagram shown in Figure 8, consider two arbitrary microphone locations 1 and 2 at the duct wall with a separation distance a , in a uniform duct of finite length with flow from left to right as indicated. The acoustic pressures measured by the microphones at these locations may be expressed as the summation of right- and left-running components as follows:

$$p_1 = p_{1r} + p_{1l} \quad (2)$$

and

$$p_2 = p_{2r} + p_{2l} \quad (3)$$

where the subscripts 1 and 2 indicate the locations, and r and l denote the right- and left-running components of the pressure. The reflection coefficients R_1 and R_2 at the two locations are defined as,

$$R_1 = F(p_{1l})/F(p_{1r}) \quad (4)$$

and

$$R_2 = F(p_{2l})/F(p_{2r}) \quad (5)$$

where F denotes the Fourier transform. Also the transfer functions associated with the right- and left-running pressures may be expressed as,

$$H_{12r} = F(p_{2r})/F(p_{1r}) \quad (6)$$

and

$$H_{12l} = F(p_{2l})/F(p_{1l}) \quad (7)$$

while the transfer function for the total pressures may be written as

$$H_{12} = F(p_2)/F(p_1) \quad (8)$$

From equations 2 to 8, it is seen that,

$$H_{12} = H_{12r} (1+R_2)/(1+R_1) \quad (9)$$

while equations 4 to 7 show that,

$$R_2 = (H_{12l}/H_{12r}) R_1 \quad (10)$$

Substituting equation 10 into equation 9 and solving for R_1 , it follows that,

$$R_1 = (H_{12} - H_{12r}) / (H_{12l} - H_{12r}) \quad (11)$$

Equations 2 to 11 are valid either for deterministic or random signals, provided Fourier transforms exist* in the case of the random signal. Generally, for a random signal, the frequency spectra, rather than the Fourier transforms, are estimated. In order for equations 2 to 11 to be valid, it can be shown that the following requirement has to be satisfied, i.e.,

$$\overline{F(p_m)} \overline{F^*(p_n)} = \overline{F(p_m)} \cdot \overline{F^*(p_n)}, \quad (12)$$

$$\begin{cases} m = 1, 2 \\ n = 1, 2 \end{cases} \quad \begin{cases} p = r, \ell \\ q = r, \ell \end{cases}$$

where the bar denotes an average value, and the asterisk indicates a complex conjugate. Equation 12 is satisfied as long as the data segments among the different sample records in the finite Fourier Transform are mutually uncorrelated. This condition can be achieved by appropriately separating the sample records.

The transfer functions associated with the right- and left-running pressures can be expressed as,

$$H_{12_r} = e^{-ik_r n} \quad (13)$$

$$H_{12_\ell} = e^{+ik_\ell n}, \quad (14)$$

where n is the distance between the two microphones and

$$k_r = k/(1+M) \quad (15)$$

$$k_\ell = k/(1-M) \quad (16)$$

are the wave numbers corresponding to the right- and left-running wave components. In equations 15 and 16, the wave number k is defined as the frequency divided by the speed of sound, while the Mach number M is the mean flow velocity V divided by the speed of sound.

* Strictly, the Fourier transform of a random signal does not exist because a random time-function is not absolutely integratable. The Fourier transform referred to here is the finite Fourier transform used in numerical computations.

The values k_r and k_l can be determined from the correlation function between p_1 and p_2 . Thus H_{12_r} and H_{12_l} can be determined using k_r and k_l together with the known distance s . However, H_{12} in equation 11 is obtained directly from the ratio of the cross-spectrum between p_1 , p_2 and the auto spectrum of p_1 , i.e.,

$$H_{12} = G_{12}/G_{11} \quad (17)$$

Using the quantities provided by equations 13 to 17, the reflection coefficient R_1 can be determined from equation (11). This computation is relatively simple and can be readily programmed into the analyzer to provide a direct readout of the reflection coefficient.

Measurement Accuracy

The accuracy of the acoustic properties measured in a duct system with flow by the transfer-function method is governed by many factors. The most important of these are discussed briefly in this section.

As with all other acoustic measurements, the signal-to-noise ratio of the acoustic signals with respect to the flow or background noise must be sufficiently high. Also, for the frequency range of the measurements, the dynamic range of the acoustic signals must be kept within the appropriate ranges of the instrumentation to avoid excessive interference from instrument noise.

The spacing of the microphones must be chosen with several considerations in mind. Microphones too closely spaced will create error due to the finite size of the microphone's diaphragm since, theoretically, each microphone is assumed to measure acoustic pressure at a point. Microphones spaced too far apart will introduce excessive wall dissipation effects. At frequencies for which the spacing is a half-wavelength of the sound, the two microphones measure redundant portions of the standing wave and the reflection coefficient calculated from equation 11 becomes indeterminate. Near these frequencies, wall dissipation and statistical errors will become dominant in the reflection coefficient calculation and large errors result. To reach a compromise among these different factors the spacing should be at least a few diameters of the microphone, no greater than a half-wavelength of sound at the maximum frequency, and equal to an integral multiple of the speed of sound times the time domain resolution of the ADC* unit. This latter requirement, coupled with adequate temperature and flow velocity information, should assure reasonably accurate computation of the functions H_{12_r} and H_{12_l} .

The frequency range in which accurate measurements can be obtained has to occur in the range where only plane waves propagate in the duct. For a circular duct of diameter d , this implies that the frequency f has to be less than $0.586(c/d)$ while for a square duct of side d , it implies that f has to be less than $c/2d$ where c is the speed of sound.

* ADC is the Analog-to-Digital Converter unit of the Fourier Analyzer.

The statistical error of the measurement is dependent on the coherence between the two microphone signals and on the number of averages used in the evaluation of the transfer function. To achieve equivalent accuracy, a high coherence requires fewer averages than a low coherence. However, the best approach is to repeat the tests using progressively more averages until the final result is essentially unaffected by the number of averages.

Calibration

The calibration of the microphone systems is accomplished by mounting two microphones at a time in a plate that can be rigidly attached to the open end of the duct. The two microphones can then be assumed to be exposed to the same noise field, and the transfer function measured in this configuration represents the response (both in amplitude and phase) of one microphone system relative to the other system.

If microphone #1 (see Figure 8) is chosen as a reference, successive comparisons of each additional microphone system with the system of microphone #1 will result in measurement of the set of transfer functions $[H_{12_c}, H_{13_c}, \dots]$

where the subscript c refers to the calibration configuration of the microphones. This set of transfer functions is then used to correct measured auto-spectra and transfer functions for microphone system response according to the following formulae:

$$[G_{11}]_{\text{corrected}} = G_{11}^{\dagger} \quad (18)$$

$$[G_{22}]_{\text{corrected}} = G_{22} / |H_{12_c}|^2 \quad (19)$$

$$[G_{33}]_{\text{corrected}} = G_{33} / |H_{13_c}|^2 \quad (20)$$

$$[H_{12}]_{\text{corrected}} = H_{12} / H_{12_c} \quad (21)$$

$$[H_{13}]_{\text{corrected}} = H_{13} / H_{13_c} \quad (22)$$

These corrected forms of the auto-spectra and transfer functions are used in the calculation of the reflection coefficients, transmission losses, and other normal-incidence acoustic properties of a duct system.

† Because microphone #1 is chosen as the reference system.

Instrumentation and Associated Measurement Procedures

The instrumentation required to perform in-duct acoustic measurements using the transfer function technique is shown schematically in Figure 9. A random-noise generator is coupled through a power amplifier to an acoustic driver unit and generates acoustic signals in the pipe. The inside diameter of the pipe used in the experiments was 51 mm, and 6.35 mm (1/4") diameter Bruel and Kjaer condenser microphones were mounted flush with the inside wall of this pipe. For this pipe diameter, the upper limit of the frequency range in which only plane waves propagate is 4 kHz.

For the reflection coefficient measurements, an axial spacing of 27 mm was used between the two upstream microphones. Thus, according to equation 11, the first indeterminate frequency occurs at 6.4 kHz which is above the frequency range of interest in the measurements. A third microphone, mounted downstream of the silencer, and an anechoic pipe termination are used in the transmission-loss measurements. The anechoic termination, which consists of a long wedge of acoustic fiberglass within a 51 mm diameter pipe, prevents the formation of downstream reflected waves and thus permits measurement of transmitted waves with only one microphone. If such a termination were not used, two downstream microphones could be used in conjunction with the transfer-function technique to decompose the downstream standing wave to determine the transmission loss.

Amplified microphone signals were fed to an HP Merlin (Model #5420) Fourier Analyzer for measurement of auto-spectra and transfer functions. These measurements are stored on the digital tape unit built into the analyzer and recalled for subsequent computations. The calibration transfer functions were measured using pairs of microphones as described in the calibration section and used to modify the auto-spectra and transfer functions according to equations 18 through 22.

The function H_{12_r} and H_{12_t} were computed by feeding Gaussian white noise voltages simultaneously to both input channels of the analyzer, time delaying one channel by $-kgn/\omega$ and kgn/ω , respectively, (according to equations 13 and 14) and computing the transfer functions. The microphone spacing of 27 mm was chosen so that these time delays (both equal to 78 μ s) were equal to the time domain resolution of the analyzer's ADC unit for the 3.2 kHz frequency range.

The computation of equation 11 was performed completely within the analyzer unit. Therefore, spectra of acoustic parameters such as reflection coefficients, transmission losses, etc., could be displayed directly on the analyzer's oscilloscope and/or an x-y plotter. The simplicity of the form of equation 11 is a key feature of this technique since it permits immediate display of the measured acoustic parameter in the laboratory without resorting to a pre-programmed digital computer.

Experimental Results

Two experiments were conducted during the two-week period that the HP Merlin analyzer was available. Choice of the experiments was based on available hardware and on ability to predict the results from known theory.

Open Pipe Termination: Reflection coefficients from an unflanged open pipe termination were measured without flow using the transfer function technique and are compared in Figure 10 with the theory of Levine and Schwinger [1]. As shown, the microphones were placed only 30 mm and 57 mm from the end of the pipe to minimize wall dissipation effects. Since the quantity calculated from equation 11 is complex, Figure 10 presents both the magnitude and the phase angle of the reflection coefficient.

The agreement between experiment and theory is seen to be quite good throughout the measured frequency range. At high frequencies, the experimentally measured reflection coefficients tend to be lower in magnitude than the theoretical values. This effect has been observed in previous measurements using the correlation technique [7]. It is probably due to wall-dissipation effects and the loss of acoustic energy through the walls of the pipe.

Inaccuracies also tend to be greater at higher frequencies due to errors caused by the finite size of the microphones and to errors in the functions H_{12r} and H_{12k} caused by the approximate values used for the speed of sound and microphone spacing. Typically, such errors vary linearly with frequency and thus are more apparent at high frequencies. The excellent agreement between theoretical and experimental reflection coefficient phase angles is somewhat surprising. Usually errors arising from inaccuracies in spatial resolution and the speed of sound create larger variations in phase than in magnitude.

Expansion Chamber Silencer: Reflection coefficient and transmission loss measurements were performed using the transfer function technique for the expansion chamber silencer shown schematically in Figure 11. The inlet and outlet pipes have a diameter of 51 mm and the chamber diameter is 152 mm giving an area expansion ratio of 9 to 1. The outlet pipe protrudes a distance of 54 mm into the chamber. Tests were conducted with an anechoic termination downstream of the silencer, as shown in Figure 9 and discussed above in the section on instrumentation and associated measurement procedures.

Reflection coefficients measured for this silencer are shown in Figure 12. Also shown are theoretical calculations for the silencer using the methods of Alfredson and Davies [9,10]. The magnitude of the measured reflection coefficient is quite low at frequencies for which the chamber length is a multiple of half-wavelengths of sound. The greatest differences between theory and experiment occur at these frequencies due to resonant energy dissipation within the silencer. Similar losses at the entrance and exit regions of the silencer prevent the reflection coefficient from being unity at the off-resonance frequencies. It appears that these losses are underestimated in the theoretical calculations.

Above 3 kHz, the experimental results fall far below the theoretical prediction. This is believed to be due to the occurrence of the first radial cross-mode within the silencer. The lowest frequency at which this mode will propagate unattenuated in the chamber is given by [11]

$$f = \frac{1.22 c}{d} = \frac{(1.22)(344 \text{ m/s})}{.152 \text{ m}} = 2760 \text{ Hz.} \quad (23)$$

The theoretical calculations do not account for the higher order modes. A similar difference between prediction and experimental results has been found using the SWR method [12].

At low frequencies, the phase angle agrees very well with theory. As the frequency increases the measured phase angles gradually lead the theoretical values more and more. This effect might be attributed to wave action occurring at the entrance to the chamber which, at high frequencies, is similar to a flanged open pipe termination. For the infinite flanged pipe, a small end correction $k' = 0.42 d$ must be added to the pipe length to predict the phase of the reflected wave [13], and such an extension of the inlet pipe length would greatly improve phase agreement between theory and experiment in the present situation. In fact, the phase correction, $\Delta\theta$, would approach the value,

$$\Delta\theta = 2k'f = 0.04 f \quad (24)$$

at high frequencies. To illustrate this effect, a modified theoretical curve for phase is shown in Figure 12 between 1.1 kHz and 2.7 kHz. As expected, the infinite flanged pipe correction slightly overestimates the correction; however, it does result in a better match with the measurements. Thus, the comparison of measured results to theory not only serves to verify the experimental technique but can be used to check and possibly to improve the accuracy of the theory.

Transmission loss (TL) data for the expansion chamber silencer are presented in Figure 13. These data are computed using measured reflection coefficients at auto-spectra upstream and downstream of the silencer in the expression

$$TL = 10 \log_{10} \left| \frac{G_{11}}{G_{22} (1+R_1)^2} \right| \quad (\text{in dB}) \quad (25)$$

where G_{11} is the upstream auto-spectrum at the point of measurement of the reflection coefficient R_1 , and G_{22} is the downstream auto-spectrum. This expression assumes use of an anechoic termination downstream of the silencer.

The measurements are compared to theoretical predictions of transmission loss also using the methods of references 9 and 10. Quarter-wave resonances over the length of the expansion chamber are responsible for the lobe structure in the TL spectra that repeats approximately every 600 Hz. The large peak near 1200 Hz is due to a quarter-wave resonance in the annular chamber region

formed by the protrusion of the exit pipe into the chamber. The decrease in the experimental TL data above 3 kHz is due to the occurrence of the first radial cross-mode within the chamber, as discussed earlier for the reflection coefficient data.

The overall trend of the experimental TL data follows that of the theoretical prediction. However, the measured data exhibit fluctuations throughout the frequency range which are not accounted for by the theory. Although the origin of these fluctuations is not known, reflected waves from the anechoic termination are suspected. If reflections were present downstream of the silencer, then G_{33} used in equation 25 would be in error due to the standing wave patterns. The associated error in TL would be of the fluctuating nature similar to the data of Figure 13 due to the presence of pressure nodes and antinodes at the downstream microphone location. A study of the acoustic characteristics of the anechoic termination section and of other silencers will be conducted in future tests.

CONCLUDING COMMENTS

In this paper we have presented results that we hoped would be of particular interest at this Symposium. The mechanism of the radiation of sound from the end of a tail pipe is an important topic in exhaust noise studies and the possibility that the acoustic pressure in the pipe may be directly related to the radiated sound should be further investigated. The transfer-function technique developed by GM Research Laboratories appears to provide, for the first time, the means of making routine measurements of the acoustic characteristics of exhaust systems with flow. We feel that this capability should be of considerable use both in exhaust system development and for possible exhaust system evaluation purposes.

Whether transmission loss data obtained in bench tests with the transfer-function technique described here can be used to predict the performance of silencers as installed in vehicles has not been investigated yet at the GM Research Laboratories. Such an investigation should involve consideration of the following effects in order to determine whether or not the effects are accounted for and, if not, what corrections are required:

1. Mean flow
2. Temperature and temperature gradients
3. Finite amplitude waves
4. Engine source impedance and tail pipe radiation impedance.

Since the transfer function technique can be used with mean flow, that effect could be accounted for directly in any bench test using the technique. As far as the two-part temperature effect is concerned, bench testing at room temperature would introduce a reduction in the speed of sound from that for the actual higher temperatures, and this effect could be accounted for by a relatively straightforward frequency correction of the transmission loss data. The effect of temperature gradients in the exhaust system, however, is not currently understood and thus the effect on silencer performance is not

predictable by any presently known method. As indicated in references 2, 9, 10 and 14, nonlinear effects due to finite amplitude waves in expansion-chamber silencers occur near resonant frequencies and, hence, can usually be neglected for design purposes. Because bench-test transmission loss data do not include the effect of the engine and tail pipe impedances, they cannot be used directly to predict either the level of noise radiated from the tail pipe or the decrease in noise level due to the insertion of the silencer. This latter measurement of silencer performance, which is termed the insertion loss, can be related to transmission loss if the engine and tail pipe impedances are known. Several workers have attempted to specify these impedances using experimental measurements [2,15]. However, their results were not sufficiently general to cover the complete range of conditions that exist in vehicle exhaust systems.

In summary, therefore, sufficient data are not yet available to correlate bench test transmission loss of silencers with noise reductions obtained when these silencers are installed in vehicle exhaust systems. Thus before bench tests can be used to develop silencer ratings, a series of silencers should be bench tested and also should be evaluated on vehicles to determine the degree of correlation. If such a correlation can be established, a frequency-dependent criterion (similar in nature to noise criteria curves used in architectural design) could perhaps be developed to determine a silencer rating from transmission loss data obtained in bench tests.

REFERENCES

1. Levine, H. and Schwinger, J., "On the Radiation of Sound From an Unflanged Circular Pipe," *Physica Review*, Vol. 73, No. 4, pp. 383-406, February 15, 1946.
2. Alfredson, R. J., and Daviau, P.O.A.L., "The Radiation of Sound From an Engine Exhaust," *J. Sound and Vibration*, Vol. 13, No. 4, December 1970, pp. 389-408.
3. Ingard, K. U., and Singhal, V. K., "Effect of Flow on the Acoustic Resonances of an Open-Ended Duct," *J. Acoustical Society of America*, Vol. 58, No. 4, pp. 788-793, October 1975.
4. Beranek, L., Acoustic Measurements, chap. 7, pp. 302-361, J. Wiley, 1949.
5. Gately, W. S. and Cohen, R., "Methods for Evaluating the Performance of Small Acoustic Filters," *J. Acoustical Society of America*, 46, pp. 6-16, 1969.
6. Singh, R. and Katra, T., "On the Dynamic Analysis and Evaluation of Compressor Mufflers," *Proceedings 1976 Purdue Compressor Technology Conference*, July 6-9, 1976, Purdue University, West Lafayette, Indiana, 1976.
7. Schmidt, W. E., and Johnston, J. P., "Measurement of Acoustic Reflections from Obstructions in a Pipe with Flow," NSF Report PD-20, March, 1975.
8. Seybert, A. F., and Ross, D. F., "Experimental Determination of Acoustic Properties Using a Two-Microphone Random-Excitation Technique," *J. Acoust. Soc. Am.*, Vol. 61, No. 5, May 1977, pp. 1362-1370.
9. Alfredson, R. J., "The Design and Optimization of Exhaust Silencers," Ph.D. Thesis, Institute of Sound and Vibration Research, University of Southampton, July, 1970.
10. Alfredson, R. J., and Daviau, P.O.A.L., "Performance of Exhaust Silencer Components," *J. Sound and Vibration*, Vol. 15, No. 2, March, 1971, pp. 175-196.
11. Harris, G. M., Handbook of Noise Control, McGraw-Hill Book Company, 1957, p. 21-16.
12. Davin, D. D., Stokes, G. H., Moore, D., and Stevens, G. L. Jr., "Theoretical and Experimental Investigation of Mufflers with Comments on Engine-Exhaust Muffler Design," NACA Report 1192, 1954.
13. Beranek, L. L., Acoustics, McGraw-Hill Book Company, 1954, p. 132.
14. Sacks, N. P., and Allen, D. L., "Effects of High Intensity Sound on Muffler Element Performance," *J. Acoustical Society of America*, Vol. 52, No. 3 (part 1), 1972, pp. 725-731.
15. Gwiniaia, A. G., and Bender, E. K., "Measurement of the Acoustic Impedance of an Internal Combustion Engine," *J. Acoustical Society of America*, Vol. 58 (supplement no. 1), Fall 1975.

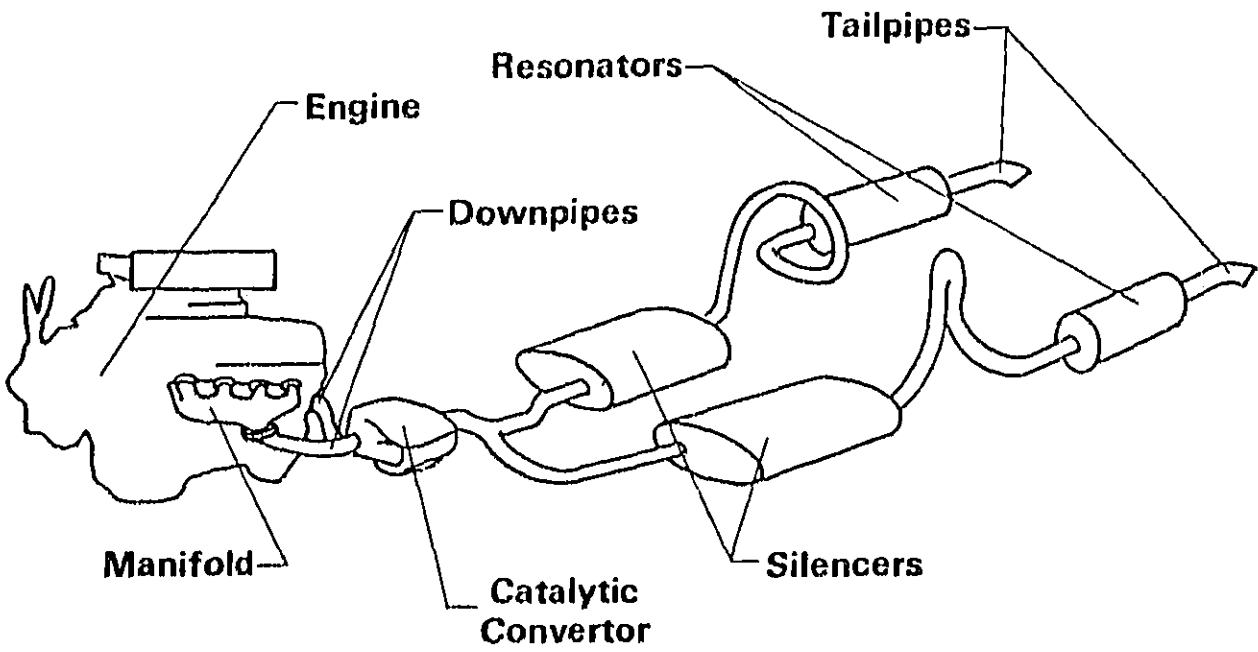

Figure 1. Components of an Engine Exhaust System.

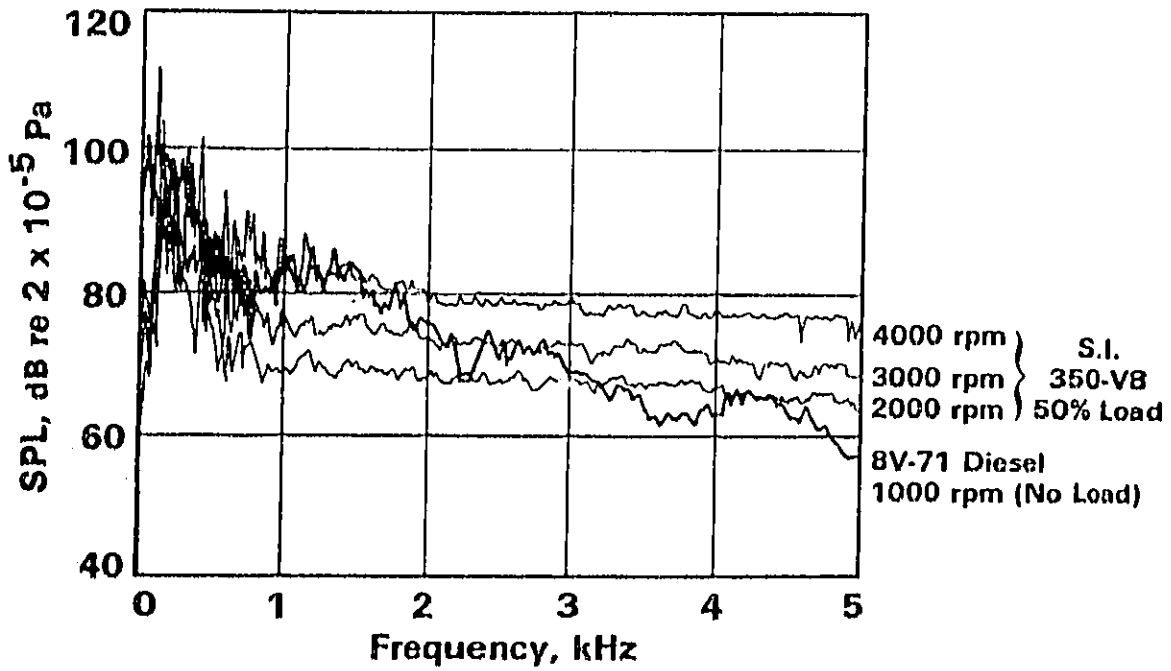

Figure 2. Radiated Exhaust Noise from Two Unsilenced Engines (measured 1.5 m from the end and 45° off the axis of the tailpipe).

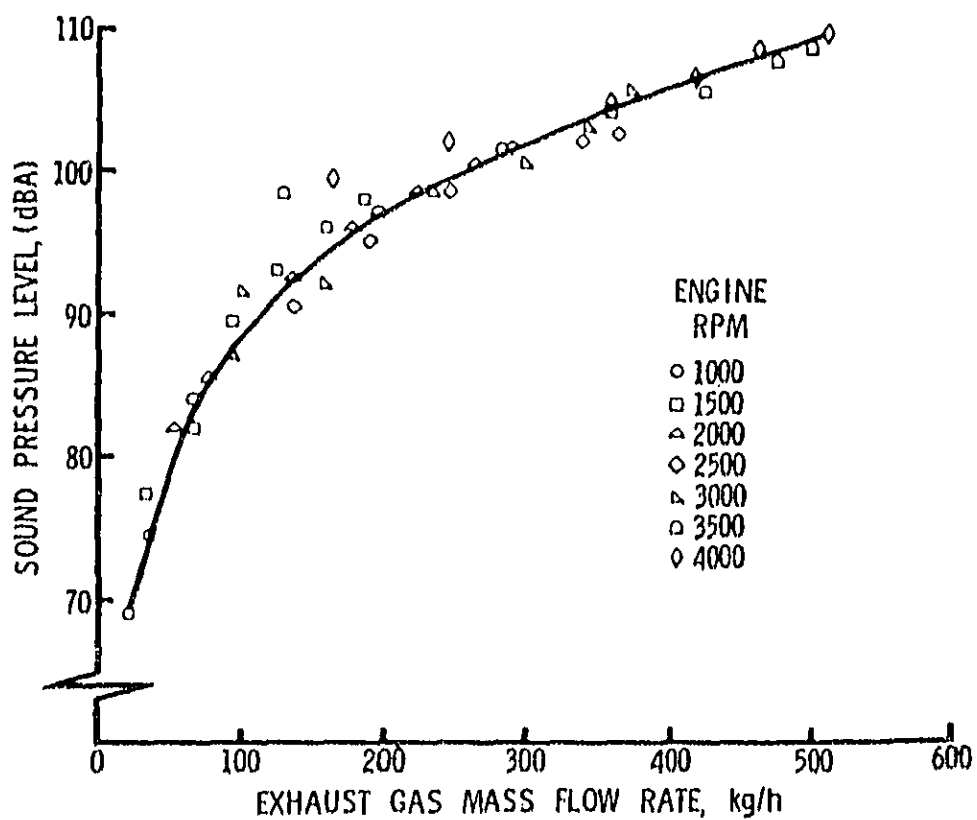

Figure 3. Radiated Exhaust Noise Versus Exhaust Gas Mass Flow Rate for a V-8 Engine.

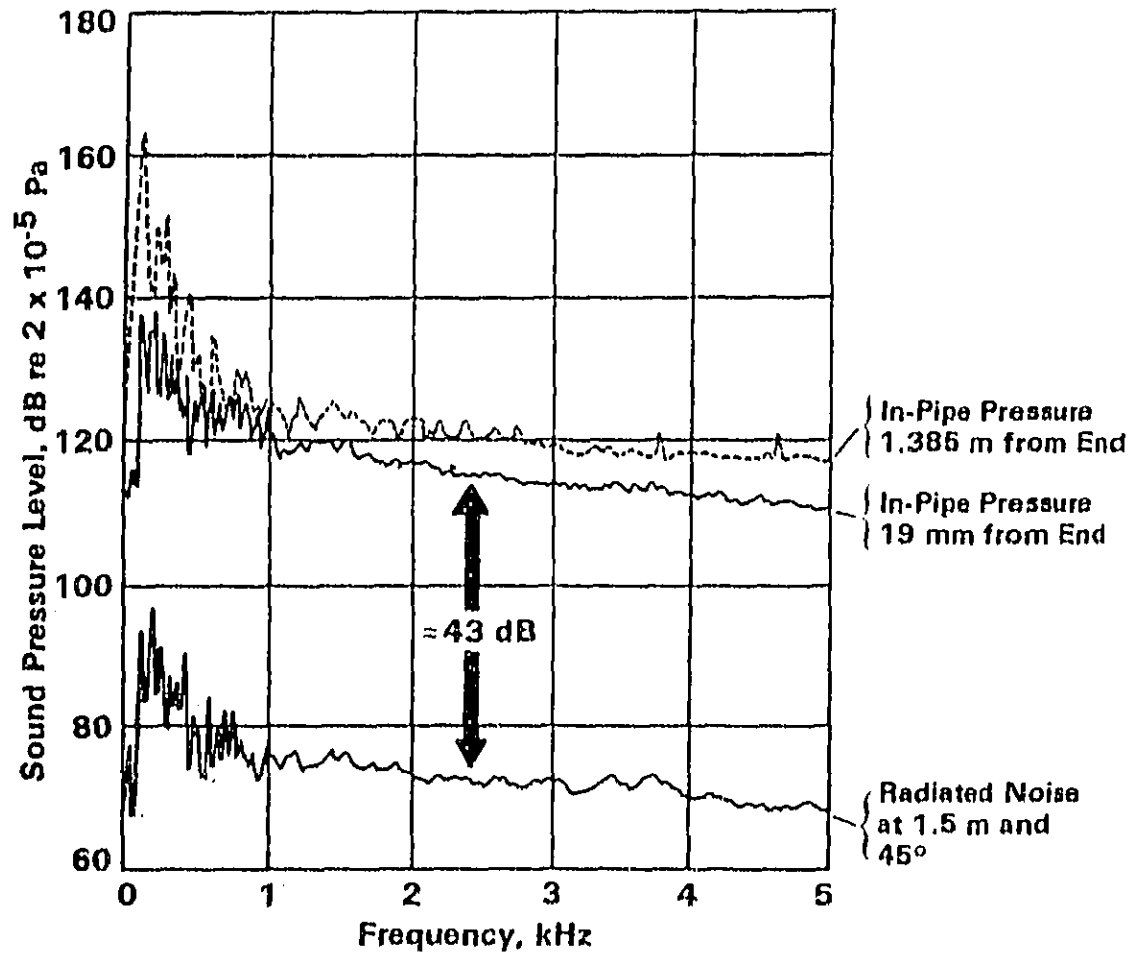

Figure 4. Comparison of Pressure Spectra in the Exhaust Pipe to Radiated Noise Spectra.

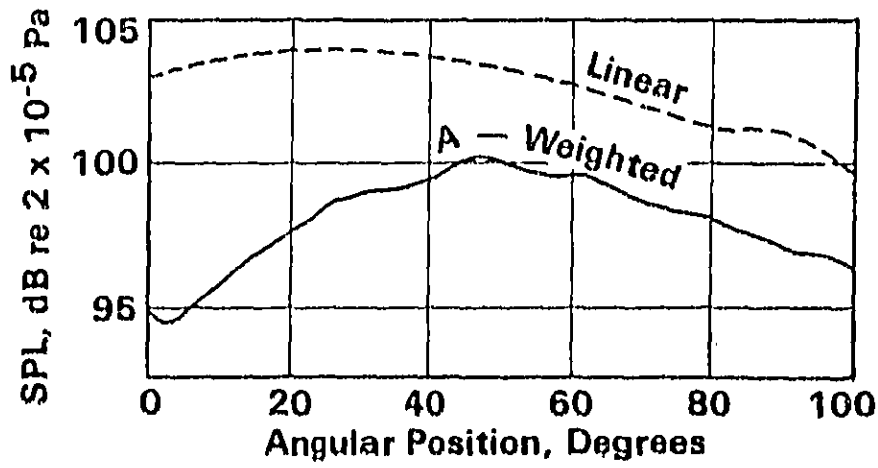

Figure 5. Linear and A-Weighted Exhaust Noise Directivity Measured 1.5 m from the End of the Tailpipe.

DEPT AVIATION ENGINEERING

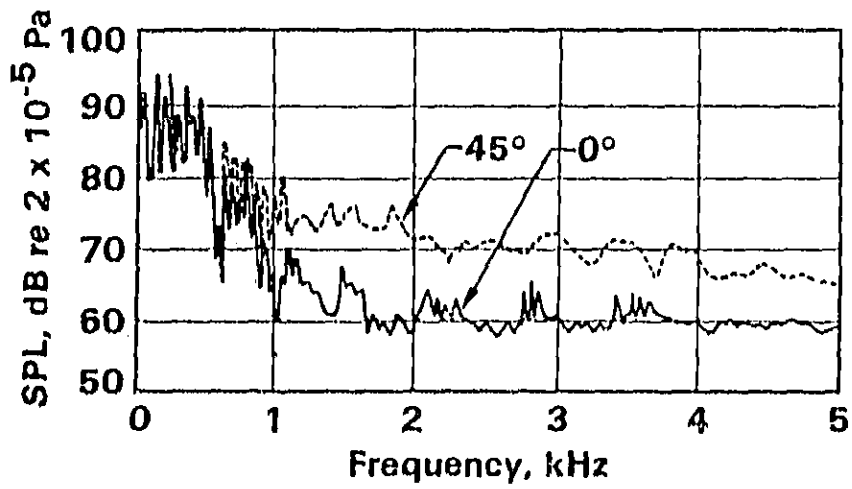

Figure 6. Exhaust Noise Spectra at 0° and 45° from the Tailpipe Axis and 1.5 m from the End of the Tailpipe.

- RPM
 ◇ 2000
 □ 1750
 △ 1500
 ◻ 1250
 ○ 1000

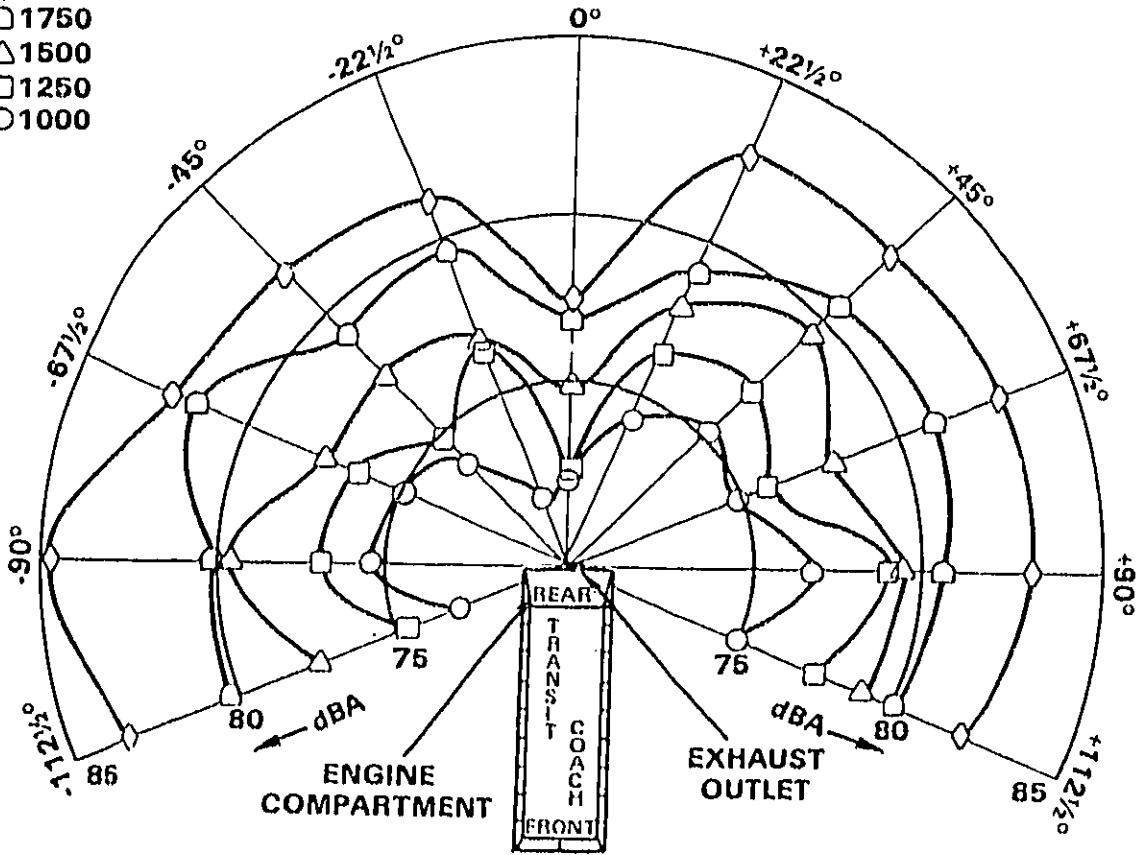

Figure 7. Directivity of Noise from a Transit Coach.

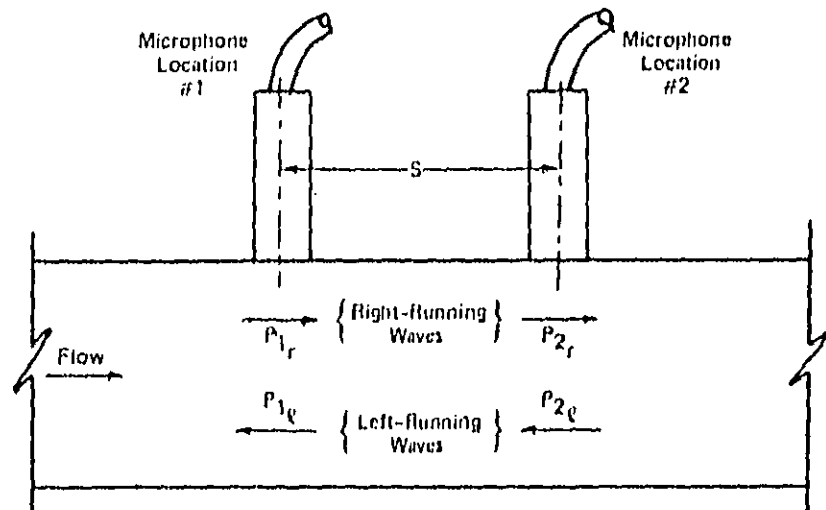

Figure 8. Microphone Configuration and Notation.

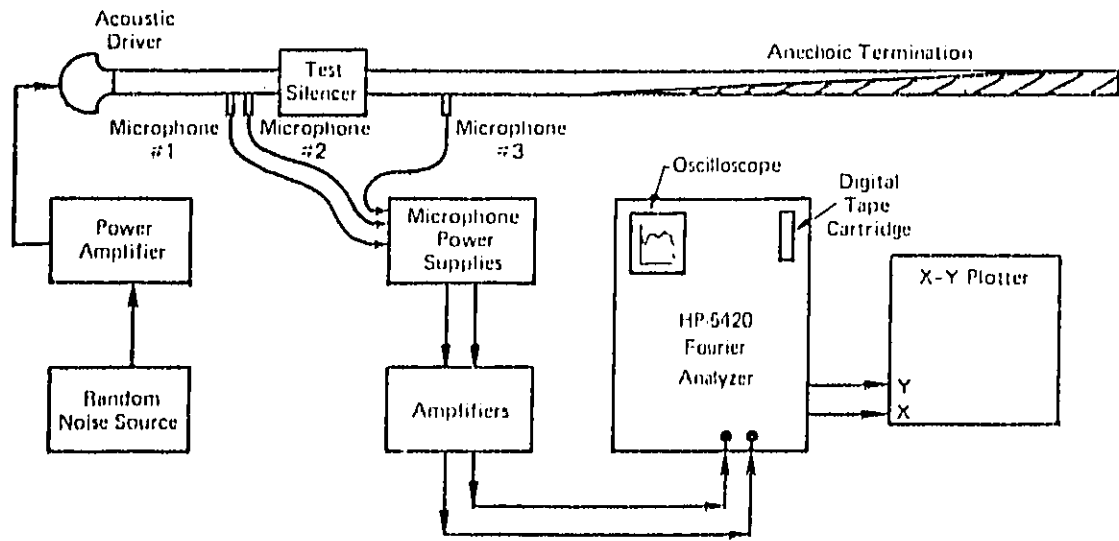

Figure 9. Test Arrangement and Instrumentation.

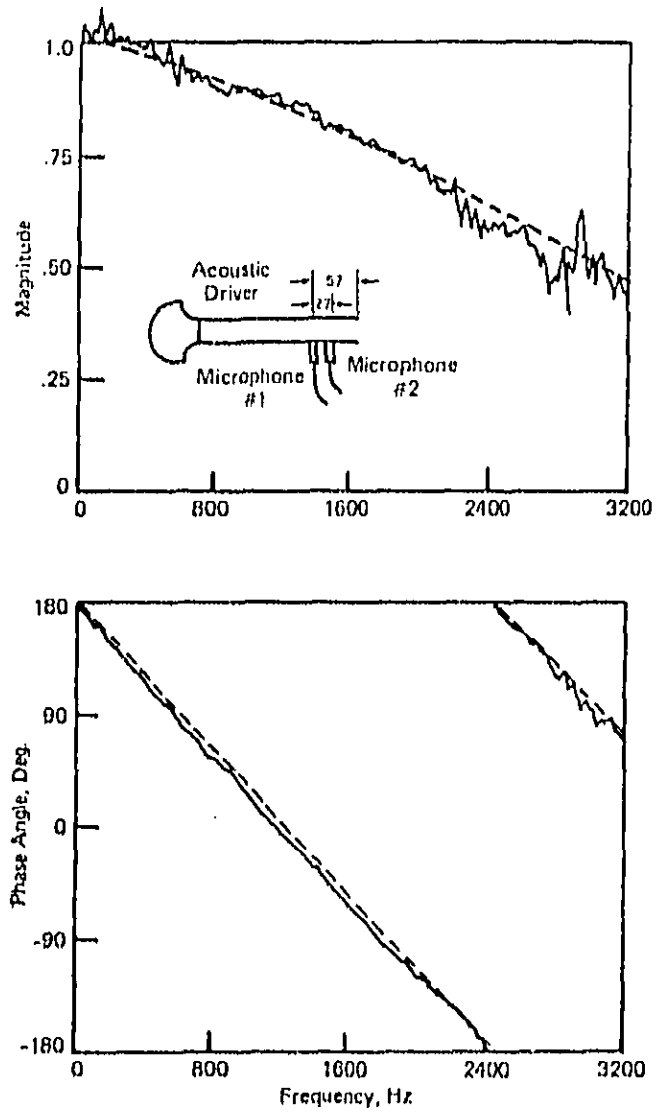

Figure 10. Magnitude and Phase Angle of the Reflection Coefficient for an Open Pipe Termination; --- theory, — experiment, (dimensions in mm).

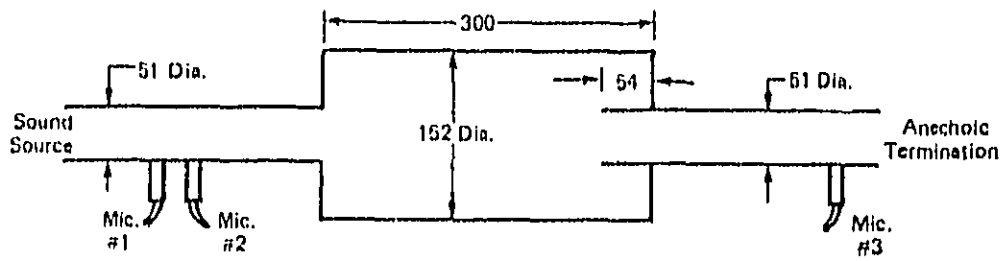

Figure 11. Expansion Chamber Silencer (dimensions in mm).

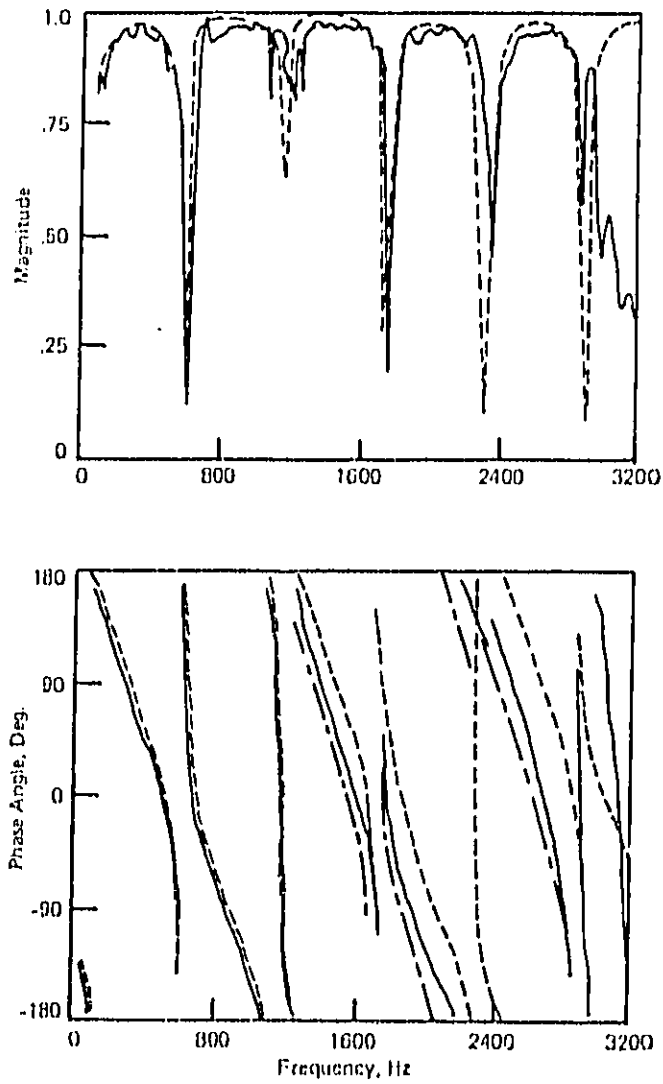

Figure 12. Magnitude and Phase Angle of the Reflection Coefficient for the Expansion Chamber Silencer; --- theory, - - - modified theory, — experiment.

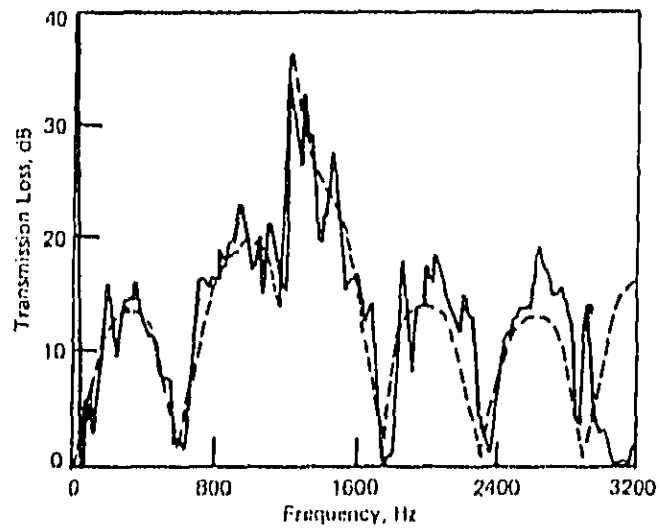

Figure 13. Transmission Loss for the Expansion Chamber Silencer; --- theory, — experiment.

A METHOD OF MEASURING EXHAUST SYSTEM NOISE

Mineichi Inagawa
Trucks & Buses Engineering Center
Mitsubishi Motors Co.

In Japan, noise regulation for motor vehicles is on the verge of becoming the strictest in the world. The noise level of heavy duty trucks and buses will be limited to under 86 dB(A) from the present 89 dB(A) by the ISO method by 1979.

Figure 1 shows the contribution of each sound source to the total noise level of Japanese heavy duty trucks and buses measured by ISO R362 method. The engines of the illustrated vehicles have from 250 to 300 horsepower outputs. Engine noise is responsible for the greatest percentage of exterior noise. Exhaust system noise, and cooling fan noise come next in order.

Our bench test on mufflers can be classified into four types.

- (1) Measurement of Acoustic Attenuation of a Muffler,
- (2) Measurement of Flow-Generated Noise of a Muffler,
- (3) Exhaust Noise Test on a Stationary Vehicle, and
- (4) Exhaust Noise Test on an Engine Bench.

(1) Measurement of Acoustic Attenuation of a Muffler

The setup of the measuring system is shown in Figure 2. The output noise is measured in a cubic anechoic test chamber. Its dimensions are 2.5 meters or 7.5 feet on all sides.

Input sound pressure to a muffler is controlled constant at 110 dB(A), and as a noise source, sinusoidal wave, white noise and taped spectrum from the exhaust of an engine are used.

Obtained data is recorded and post-processed by a computer.

Figure 3 shows our way of expressing "Acoustic Attenuation". The difference of noise level between the reference straight pipe which is referred to as the "Base Model", and the tested muffler is designated as "Acoustic Attenuation".

An example of frequency response of the "Base Model" is shown in Figure 4 in order to compare the fundamental elements of mufflers. In this case, the equivalent length is 175 millimeters or 6.9 inches.

The fundamental elements configuration and their parameters are illustrated here (Ref. Figure 5). Though the expansion chamber type and the resonator type muffler seem to be the most popular, the multi-hole type is widely used and reveals an interesting feature which I will mention later.

Figure 6 shows acoustic attenuation which I mentioned earlier in relation to sinusoidal wave. We have shown an expansion chamber type here as an example. This example is a very simple one-chamber model. In this case, it is meaningless to illustrate the measurements and calculations of frequencies above 2000 Hertz.

Figure 7 shows one response of the resonator type muffler. As the number of holes is increased, its features begin to resemble those of the expansion chamber type.

Next is shown an example of a response using white noise to compare with that of sinusoidal wave. This comparison is made with the multi-hole type muffler (Ref. Figure 8).

The attenuation characteristics using sinusoidal wave are represented by the dotted line and those of the 1/3 octave band using white noise are shown by the dots. In such simple models as this one, the 1/3 octave band noise is sufficient to illustrate the acoustic features of the muffler. When white noise is the input, an attenuation at frequencies beyond 2 kHz, and overall, are obtained.

Figure 9 shows the attenuation characteristics of an actual muffler for a vehicle. All the mufflers have a diameter of 280 mm, and are 1 meter in length. Frequencies of above 2000 Hz are best attenuated by type C. The A-scale level also shows the best results. Figure 10 shows an example of acoustic attenuation with respect to a twin muffler. When the actual exhaust noise of the engine is used instead of white noise, the spectrum poses a problem. Figure 11 is the spectrum of the exhaust noise from a V8 14.8 liter diesel engine without a muffler. This 2400 rpm spectrum resembles that of white noise and this was used as the sound source.

The acoustic attenuation of the noise of a muffler with white noise input and the noise of a muffler with actual engine exhaust noise input were compared using overall dB(A). The difference in acoustic attenuation due to the difference in input spectrum was slight and good correlation was seen. Accordingly, we decided to use white noise input for acoustic attenuation studies.

(2) Measurement of Flow-Generated Noise of a Muffler

As a flow source, we used a rotary blower and a normal air flow was supplied to the test muffler through a silencer. The flow-generated noise was measured using a cubic anechoic test chamber. The rotary blower used, had a flow volume of 54 m³/min at 200 mmHg in order to simulate the exhaust gas flow at full load of a 300 horsepower class diesel engine which we manufacture. (Ref. Figure 13)

Using this equipment, we tested various mufflers to obtain their flow-generated noise levels. (Ref. Figure 14)

The change in noise levels according to the differences in flow speed were as follows;

When flow speed is less than 50 m/s, noise level is proportional to the value of V to the fourth power, where V represents the flow speed.

When flow speed is less than 100 m/s, noise level is proportional to the value of V to the sixth power, and when flow speed is more than 100 m/s, noise level is proportional to the value of V to the eighth power or more.

We discovered the following tendency when testing the fundamental elements of the muffler (Ref. Figure 15). The flow-generated noise showed a tendency to be higher in the expansion chamber type and the multi-hole type muffler.

I would like to show typical examples of the spectra. Two tendencies were observed. (Ref. Figure 16). First, as the amount of flow increases, the dominant frequency was seen to rise to the higher range and at the same time noise level is increased.

In the case of multi-hole type mufflers the noise level gradually increased, and as you can see in the figure the dominant frequency is above 2 kHz.

The flow-generated noise level was evaluated the same as acoustic attenuation using differences of the levels of the test mufflers based on the straight pipe. (Ref. Figure 17)

We tested a typical muffler and found that in mufflers which do not produce a whistling noise the flow-generated noise level remained constant when the amount of flow exceeded a certain limit. (Ref. Figure 18)

Next, the correlation between the data obtained using the flow-generating equipment and exhaust noise of the actual vehicle depends on the correspondence of air-flow. The effect of engine rpm and the temperature of the exhaust system was studied using testing equipment for the exhaust noise of stationary vehicles. I will mention this later. (Ref. Figure 19)

The difference in temperature between the inlet and outlet of the exhaust system is from 200 to 300 degrees centigrade, and when the back pressure of this flow-generated noise and that of the actual vehicle are compared, it was found that better correlation is seen when the rate of flow is converted at the outlet temperature of the tail pipe.

From this result, engine rpm and the exhaust flow rate can be approximately related as shown in Figure 20.

When correspondence is made at the outlet temperature of the exhaust system, the actual exhaust noise and the flow-generated noise of the vehicle, when compared in the same muffler, is as shown in Figure 21. And in this case, the flow-generated noise accounts for only a small percentage of overall exhaust noise.

And also from our experience, if the muffler is normal and does not produce any whistling noise, it can be said at present that flow-generated noise contributes only slightly to overall exhaust system noise.

(3) Exhaust Noise Test on a Stationary Vehicle

Figure 22 is the layout of the testing equipment.

The base of this testing equipment is a heavy-duty truck of a maximum payload of 11 tons, equipped with a 305 horsepower V-8 diesel engine.

An Eddy Dynamometer was mounted on the rear body of the truck and connected to the engine through a transfer to absorb the engine output and also for automatic speed control of the engine.

For this test, the exhaust system was mounted at the side of the vehicle and a sound insulating wall was set to avoid the influence of engine noise and other noise from the vehicle. By using this apparatus, radiated noise from the exhaust system can also be easily evaluated.

Figure 23 shows the changes in the exhaust noise with respect to its temperature. The engine was operated at the speed of its maximum output, and the level of exhaust noise which is represented by "NL3" in this figure, goes up as the temperature rises while the level of radiated noise goes down.

The change in the spectrum is shown in Figure 24. For the exhaust noise, the spectrum below 2000 Hertz tends to rise as the temperature rises. And for radiated noise, the spectrum above 1 kHz tends to decrease as the temperature rises.

The Figure 25 shows a muffler which was shown earlier. This figure shows the relationship between the exhaust noise and the back pressure when different arrangements of pipes, tail pipes, and sub-muffler were applied to the muffler shown earlier. From this result, you can see that a difference of a few dB(A) is seen when the exhaust pipe and tail pipe are arranged differently.

The relationship between the back pressure and the attenuation is inversely proportional. When one increases the other decreases, and the quickest (fastest) way to achieve sufficient attenuation without raising the back pressure is to carefully add another muffler.

The relationship between the attenuation of stationary vehicles and acoustic attenuation which was mentioned before is shown in Figure 26.

The solid line shows a one-to-one correlation ratio and as you can see, there is bad correlation between acoustic attenuation by white noise and the attenuation by using the engine of the vehicle. The attenuation on the vehicle is much greater.

When this is compared using the spectrum it can be expressed as the following. (Ref. Figure 27) In the attenuation spectrum obtained from the engine, attenuation above 2 kilz tends to increase compared to the acoustic test and on the contrary, the attenuation of the spectrum near 500 Hz tend to be much lower. At present, we have not been able to explain the causes for these phenomena. And this will be the object of further study.

(4) Exhaust Noise Test on an Engine Bench.

The method of measuring the exhaust noise in engine bench test is specified by the Japan Industrial Standard D1616. (Ref. Figure 28). This standard specifies only the microphone location and the running conditions of the engine, but we have also considered the length of the exhaust pipe and the tail pipe. Also some measures should be taken to avoid the influence of radiated noise from the exhaust system.

"La" must be equal to the length of the exhaust pipe of the actual vehicle, and also "Lb" must be equal to the length of the tail pipe of the actual vehicle.

The microphone is set at an angle of 45 degrees and a position of 50 centimeters with respect to the exhaust pipe axis.

The engine bench test, in essence, is the same as the bench test of the stationary vehicle which was mentioned before so the correlation between these two tests were not checked.

Figure 29 shows the relationship between the attenuation and the back pressure of different engines and a variation of mufflers on the bench test. The figure on the right shows the amount of noise attenuation and the figure on the left shows the back pressure. They both show good correlation.

The engines compared here are the V8 pre-combustion chamber type with a volume of 13.27 liters and maximum output of 265 horse-power and the V8 direct-injection type with a volume of 14.8 liters and maximum output of 305 horse-power. We regret that we did not make any comparison with the in-line 6 cylinder type.

Next, Figure 20 shows the relationship between the exhaust noise of the engine bench test and that of the actual vehicle. And in this case, the relationship changes greatly depending upon the ratio of the exhaust noise to the various other noise of the vehicle. For this vehicle the amount of exhaust noise on the right side of the vehicle is about 30 percent. The upper line shows the acceleration noise measured by ISO method when the microphone was set at 3 meters from the center of the vehicle, and the lower line when the microphone was set at 7.5 m from the center of the vehicle.

We have drawn the conclusion that the most practical method of measuring the noise from the exhaust system is to use the engine bench. However, sufficient consideration must be given to the length of the exhaust pipe and the tail pipe, also it is necessary to consider the influence of radiated noise, and to estimate the level of back pressure.

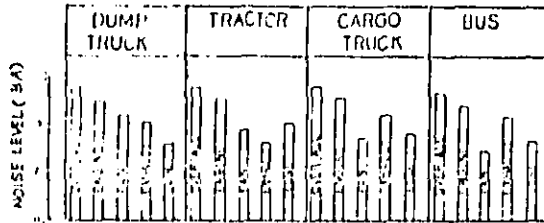

FIG-1 THE CONTRIBUTION OF SOUND SOURCES TO LARGE TRUCKS AND BUSES IN JAPAN ISO R362.

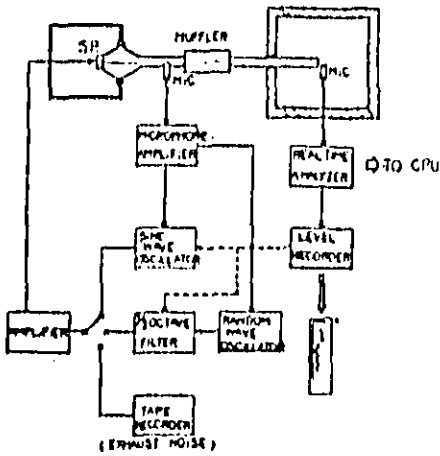

FIG-2 BLOCK DIAGRAM OF ACOUSTIC ATTENUATION MEASURING SYSTEM

FIG-3 ACOUSTIC ATTENUATION

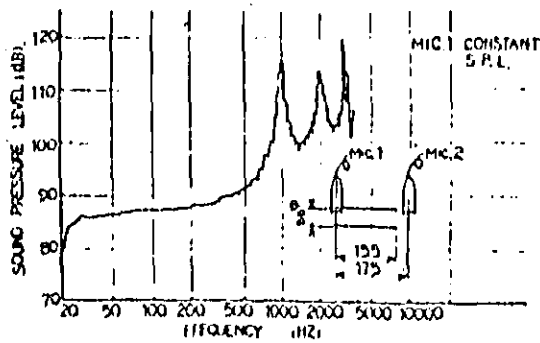
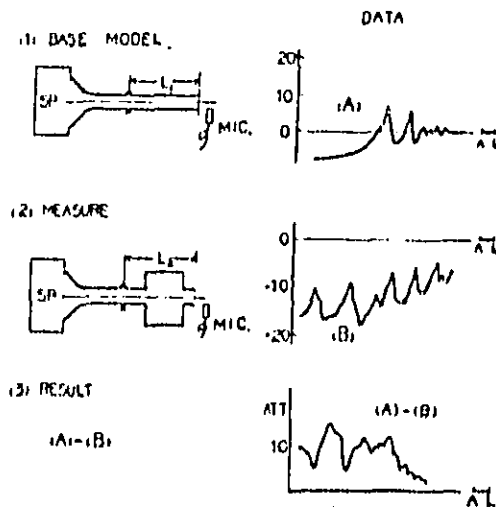

FIG-4 RESPONSE OF 'BASE MODEL' 85

FIG-5 Fundamental elements configurations and their parameters of exhaust system

Type	Parameter	Shape
Expansion chamber type	D L L_1 L_2 L_3 L_4 D	
Resonator type	L_1 n D_1 L_2 L	
Multi-holes type	D_1 n Separator installed or not	
Exhaust pipe	R s	
Tail pipe	Elliptic type Square type	

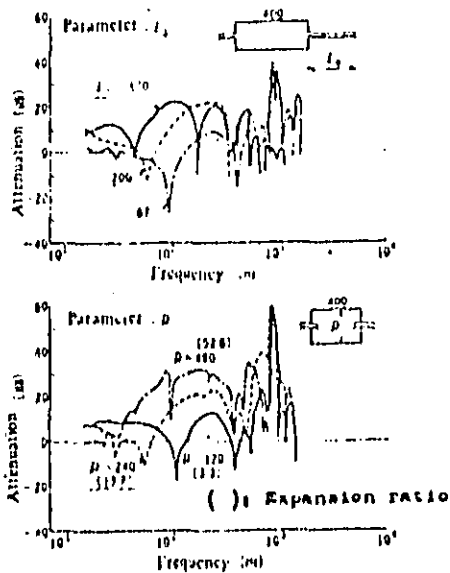

FIG-6 Attenuation of the expansion chamber type mufflers

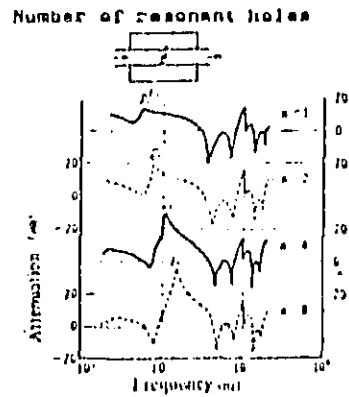

FIG-7 Effect of number of resonant holes

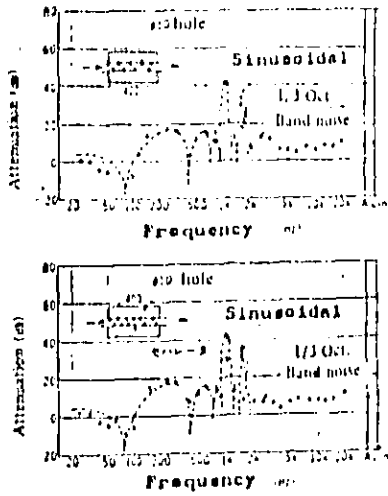

FIG-8 Effect of noise source to the attenuation characteristic of mufflers

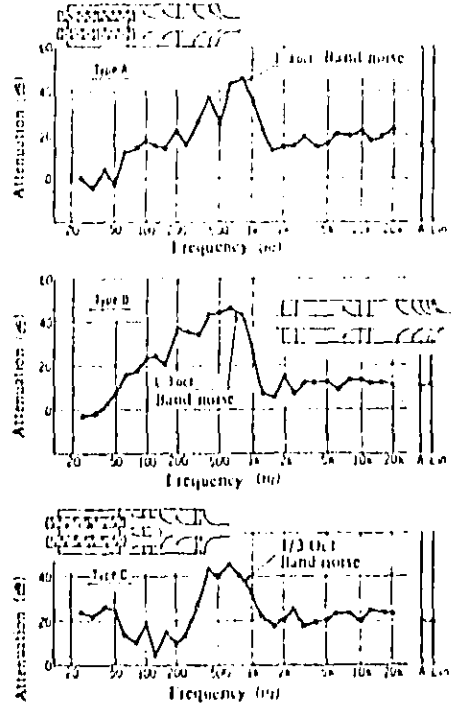

FIG-9 Acoustic attenuation of various test mufflers

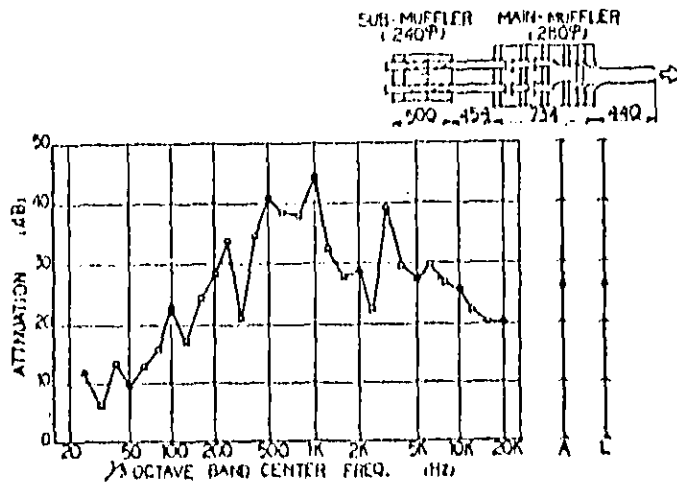

FIG-10 EXAMPLE OF ACOUSTIC ATTENUATION OF MUFFLER

PROJECT AVANTI ASB1 E 00000

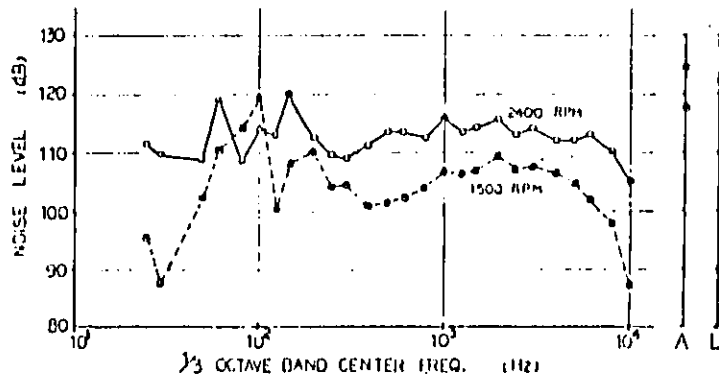

FIG-11 THE SPECTRUM OF EXHAUST NOISE EMITTED FROM ENGINE MANIFOLD

FIG-12 ACOUSTIC ATTENUATION OF MUFFLER

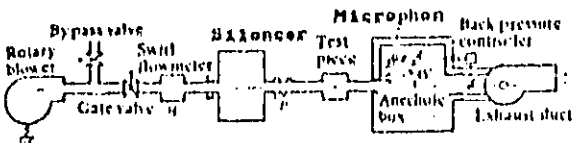
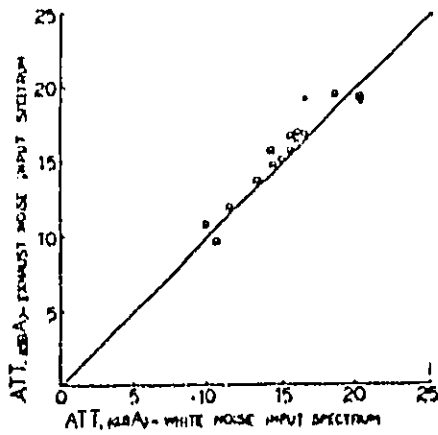

FIG-13 Experimental layout for flow generated noise

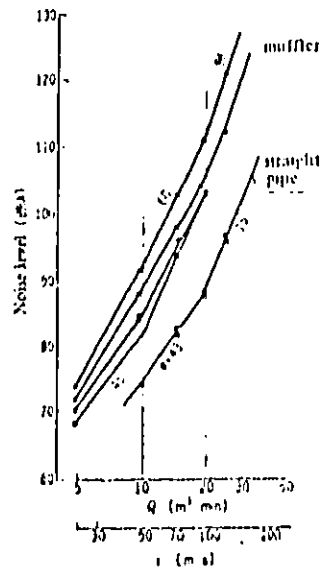

FIG-14 Flow generated noise level under various mufflers

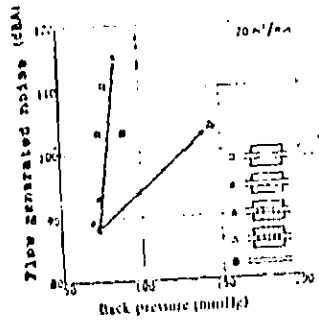

FIG-15 Relation of flow generated noise and back pressure of typical muffler elements

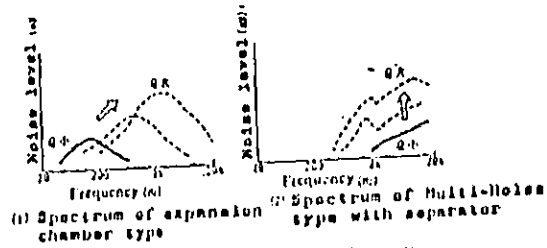

FIG-16 Change of flow generated noise spectra by air flow rate

FIG-17 FLOW GENERATED NOISE

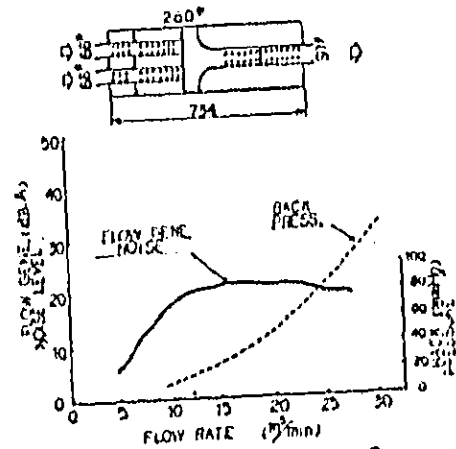
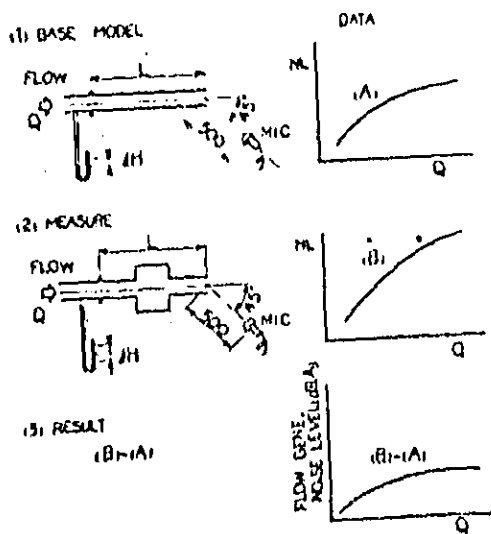
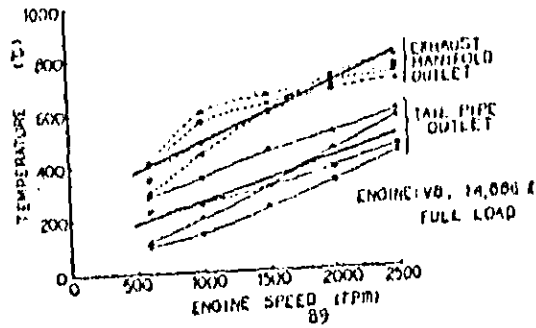

FIG-18 EXAMPLE OF FLOW GENERATED NOISE



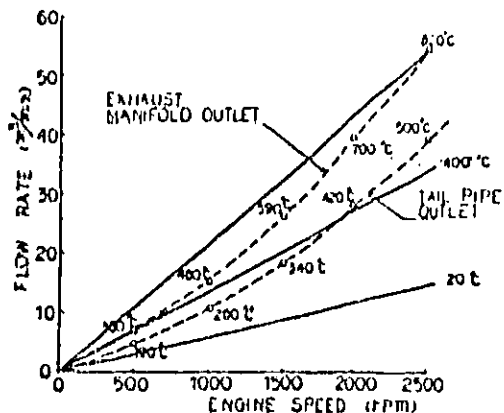

FIG-20 RELATION BETWEEN ENGINE SPEED AND EXHAUST GAS FLOW

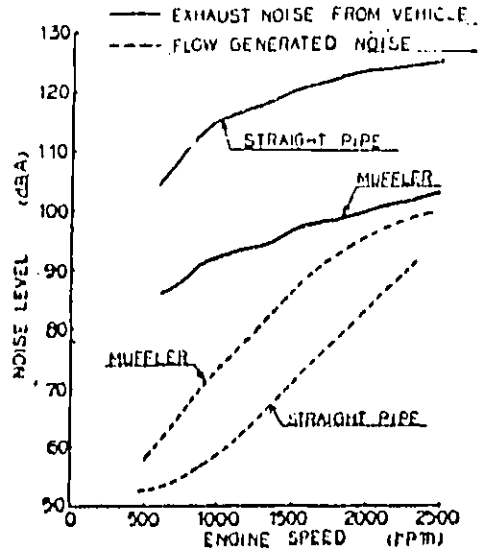

FIG-21 COMPARISON OF EXHAUST NOISE AND FLOW GENERATED NOISE

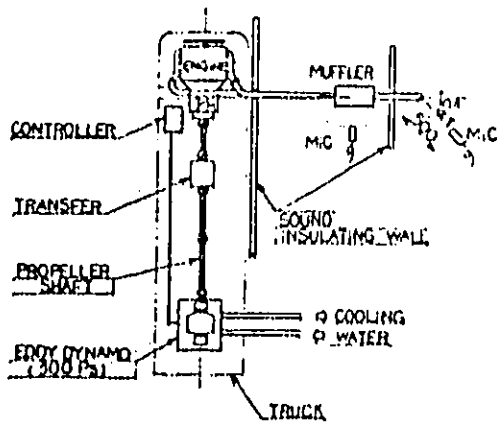

FIG-22 DIAGRAM OF EXHAUST NOISE MEASURING INSTRUMENT ON A STATIONARY VEHICLE

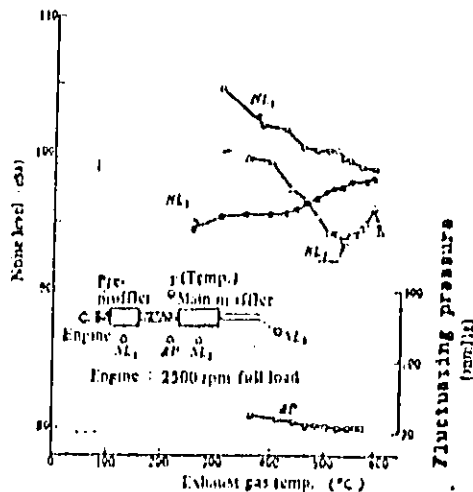

FIG-23 Influence of exhaust gas temperature on exhaust system noise

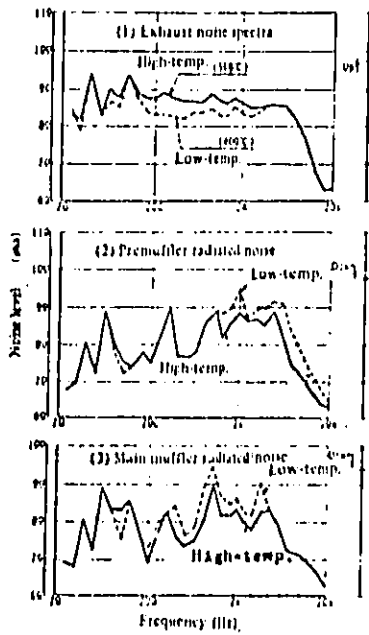

FIG-24 Influence of exhaust gas temperature on exhaust noise spectra

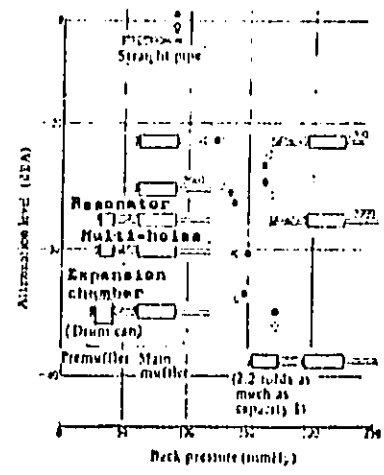

FIG-25 Relation of exhaust noise reduction and back pressure of various exhaust system arrangements

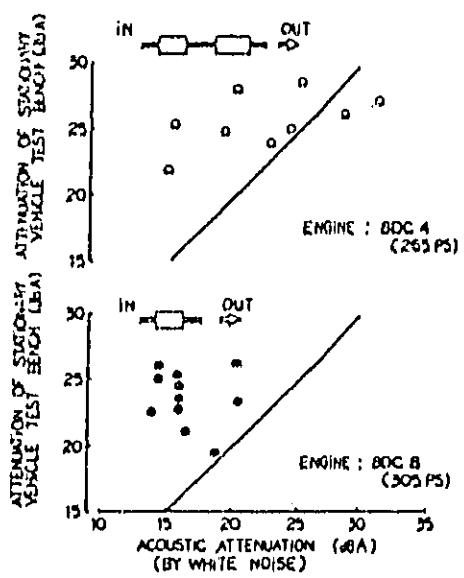

FIG-26 RELATIONSHIP BETWEEN ACOUSTIC ATTENUATION AND ATTENUATION OF STATIONARY VEHICLE

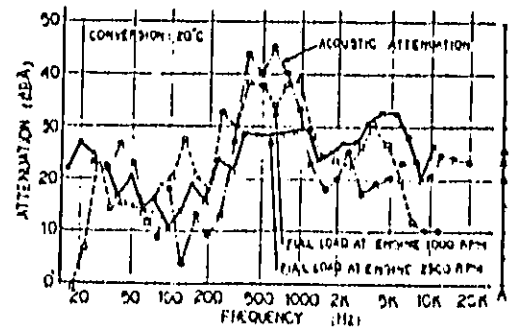

FIG-27 COMPARISON OF ATTENUATION SPECTRUM

BEST AVAILABLE COPY

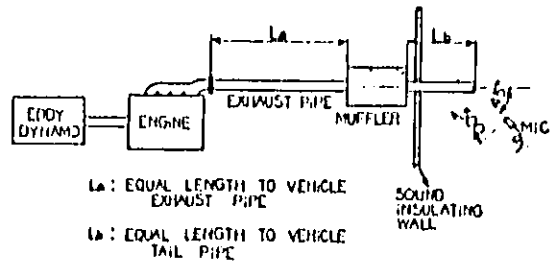

FIG-28 DIAGRAM OF EXHAUST NOISE TEST ON A ENGINE BENCH

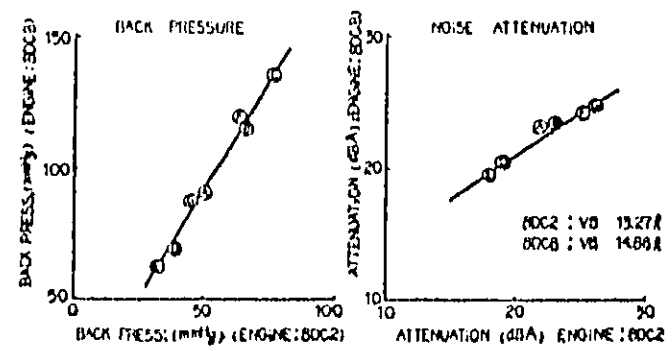

FIG-29 INFLUENCE OF MUFFLER CHARACTERISTICS TO DIFFERENT ENGINE ON A ENGINE BENCH TEST

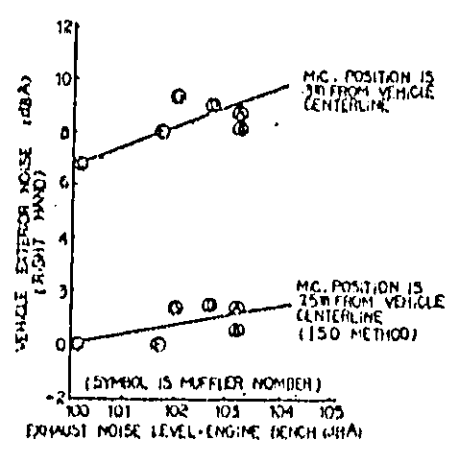

FIG-30. INFLUENCE OF EXHAUST NOISE TO VEHICLE EXTERIOR NOISE

A Study on the Reduction of the Exhaust
Noise of Large Trucks

By Tomoyuki HIRANO *
Katsu TODA **
Toshimitsu SAITO ***
Mitsuki INAGAWA ***
Kou NAKAMURA ***

Summary

Traffic noise in urban areas is posing a serious problem in many countries of the world and the reduction of the vehicle noise of large trucks is now a social problem requiring immediate solution in our country.

To cope with the social circumstances, four major large truck manufacturers have been conducting a joint research on the reduction of the noise of large trucks under the leadership of the Ministry of International Trade and Industry as a three-year project. Mitsubishi Heavy Industries is in charge of the reduction of exhaust noise which is one of the main sources of vehicle noise.

The exhaust noise of trucks can be divided into discharge noise emitted from the exhaust outlet and radiated noise emanated from the surfaces of the exhaust pipes and mufflers.

This paper reports on the results of our experiments made on the reduction of the exhaust noise of actual trucks on the basis of the results of our basic studies including acoustic study and studies on air flow noise and radiated noise.

1. INTRODUCTION

The worldwide problem of reducing city traffic noise has increasingly drawn the attention of many countries. We, in Japan, are also deeply concerned about the urgent problem of reducing vehicle noise.

The effect that large-scale trucks and buses have on traffic noise varies somewhat depending on such factors as vehicle speed, traffic volume and the ratio of large-scale vehicles to other vehicles in a certain area. However, it is a fact that they do contribute a great deal to traffic noise and furthermore, the general public also point to large-scale trucks and buses as being noisier than other vehicles.

Consequently, the administrative authorities of countries all over the world are successively establishing noise control laws mainly for large-scale trucks and buses. Japan was one of the first ones to realize such laws, for in September, 1975, the Japanese Ministry of Transportation set strict regulations of lowering -3dBA for large-scale trucks and -2dBA for passenger cars. Moreover, the Central Council for Public Nuisance Measures proposed a draft for further restricting noise another -3dBA which will be put into effect in 1979.

Under these circumstances, the Ministry of International Trade and Industry started in 1974 a major technical research and development project on noise reduction of large-scale trucks, and a joint research program was begun based on a 3-year plan by four large-scale truck manufacturers (Isuzu, Nissan Diesel, Hino, and Mitsubishi).

* Truck/Bus Testing Department Manager, Technical Center, Mitsubishi Motors Corporation
** Component Testing Section Manager, Truck/Bus Testing Department, Technical Center
*** Component Testing Section, Truck/Bus Experiment Department, Technical Center

During the first two years, research work was divided and each of the four companies was put in charge of studying different subsystems such as engine noise, cooling system noise, exhaust system noise, etc. On the third year, the four companies exchanged the results of their two-year studies and then, each company began working on developing its own low-noise proto-type truck.

In this project, the research area that Mitsubishi was in charge of noise reduction of the exhaust system. We were able to obtain substantial results during this two year period. Therefore, we would like to present a brief summary of our results.

2. CONTENTS OF INVESTIGATION

In studying the exhaust system noise reduction, feasibility of large-scale truck exhaust system was taking into consideration in determining the target and conditions. Test and research were conducted accordingly.

2.1 Target of Study and Conditions

- (1) Reduction target: 8 dBA in exhaust noise reduction (at the max. output of the engine)
- (2) Muffler back pressure: Less than 60 mmHg in pressure losses at the muffler
- (3) Muffler size: 1,000 mm in cavity length, outside diameter less than 300 mm
- (4) Type of muffler: Reactance type without using any sound absorbing material

To systematically investigate noise from the exhaust system, a lot of fundamental elements of the exhaust pipe and tail pipe composing the muffler are fabricated as prototype exhaust systems with the basic and mountable shapes on the vehicle. The following items are tested for study.

2.2 Investigation Items

- (1) Acoustic investigation
Investigation of the acoustic attenuation characteristics of the exhaust systems using a speaker as the sound source
- (2) Investigation of draft noise (flow generated noise)
Investigation of noise which is produced due to a draft corresponding to an exhaust gas stream flowing through the exhaust system of the vehicle
- (3) Investigation of radiated noise from the exhaust system
Investigation to obtain correlation between vibration and noise which are produced by vibrating the exhaust system, also to grasp the radiated noise in the vehicle.
- (4) Investigation of the exhaust noise in vehicle
Investigation of the exhaust system fabricated for trial based on the investigation results of items (1) and (2) on the vehicle

3. ELEMENTS TESTED

The fundamental elements of the exhaust system which are currently used for trucks are provided as test elements. To facilitate a variety of combinations of these fundamental elements, the outer shell of the muffler and separator are constructed to permit splitting and coupling. Typical examples of the test elements are shown in Table 1. The pre-muffler, main muffler, tail pipe submuffler, exhaust pipe and tail pipe are provided as test elements for the vehicle.

- (1) The pre-muffler is fabricated for trial based on the resonance and expansion type fundamental elements.
- (2) The main muffler is fabricated for trial based on combination of the perforated-pipe gas dispersion

Table 1 Fundamental elements configurations and their parameters of exhaust system

Type	Parameter	Shape
Expansion chamber type	D L L_1 L_2 L_3 n	
Resonator type	L_1 n D_1 L	
Perforated-pipe Gas Dispersion (Multi-holes type)	D_1 n Separator installed or not	
Exhaust pipe	R θ	
Tail pipe	Ellipse type \circ Square type \square	

and expansion type elements taking into consideration the acoustic and draft characteristics and back pressure.

(3) The tail pipe submuffler is constructed with easy mounting and demounting mainly based on the resonance type in trial fabrication to secure attenuation of a characteristic frequency.

4. SOUND TESTS

4.1 Calculation of Muffler Sound Attenuation

In calculating the acoustic attenuation characteristics of the exhaust system, there are the Davies and Illrath methods which take into consideration the mean Air flow of exhaust gases. However in this paper, the calculation were performed based on the analysis method of Fukuda and Ohtera.

The following hypothetic conditions are provided in calculating the noise attenuation of the exhaust system.

- (1) Sound pressure is much lower than the mean pressure in the pipe.
- (2) The density and sound speed of the medium in the pipe are uniform.
- (3) Influences and energy losses due to the viscosity of the medium are neglected.
- (4) The wall surface is not vibrated and acoustic energy does not transmit the wall.
- (5) Influences of draft are neglected.
- (6) The sound wave in the pipe is a plane wave which travels in an axial direction.

Under these conditions, let us assume that without the muffler installed, radiation power at the outlet is represented by W_1 , a volume velocity of wave motion at the outlet opening by U_1 and radiation resistance

at the outlet opening by R_2' , and that with the muffler, these factors are respectively represented by B' , U_2' and R_2' . Acoustic attenuation of the muffler can be expressed as:

$$Att = 10 \log_{10} \frac{W_1'}{W_2'} = 20 \log_{10} \frac{U_1'}{U_2'} + 10 \log_{10} \frac{R_1'}{R_2'} \quad \dots (1)$$

Assuming that P shows an rms value of sound pressure, U an rms value of the volume velocity of wave motion, suffix 1 the inlet opening and suffix 2 the outlet opening, the matrix of the exhaust pipe without the muffler (pipe length: l) can be expressed as:

$$\begin{bmatrix} P_1' \\ U_1' \end{bmatrix} = \begin{bmatrix} A' & B' \\ C' & D' \end{bmatrix} \begin{bmatrix} P_2' \\ U_2' \end{bmatrix} \quad \dots (2)$$

The matrix of the whole exhaust pipe system with the muffler is represented as:

$$\begin{bmatrix} P_1 \\ U_1 \end{bmatrix} = \begin{bmatrix} A & B \\ C & D \end{bmatrix} \begin{bmatrix} P_2 \\ U_2 \end{bmatrix} \quad \dots (3)$$

Let us consider the case that when the sound source has a constant sound pressure, its sound pressure does not vary regardless of installation of the muffler ($P_1' = P_1$) and that radiation resistance at the outlet opening has also an expression of ($R_1' = R_2$) as an assumption. Equation (1) will be:

$$Att = 20 \log_{10} B - 20 \log_{10} B' \quad \dots (4)$$

Hence if values B and B' are found by substituting an electric circuit for the matrix of the whole exhaust system, attenuation can be obtained.

Fundamentally speaking, when ρ , c , S and l respectively represent the density of a medium, each mean value of sound velocity, the sectional area of the pipe, and pipe length with the pipe opened at both openings, the following equation is given.

$$\begin{bmatrix} A_s & B_s \\ C_s & D_s \end{bmatrix} = \begin{bmatrix} \cos kl_s & j \frac{\rho c}{S_s} \sin kl_s \\ j \frac{\rho c}{S_s} \sin kl_s & \cos kl_s \end{bmatrix} \quad \dots (5)$$

where $A = 2\pi f/c$

When the pipe closes at one opening, the equation is represented as follows.

$$\begin{bmatrix} A_s & B_s \\ C_s & D_s \end{bmatrix} = \begin{bmatrix} 1 & 0 \\ j \frac{\rho c}{S_s} \tan kl_s & 1 \end{bmatrix} \quad \dots (6)$$

Attenuation is calculated by obtaining value B substituting equation (5) and (6) for equation (3) and using equation (4) based on $B' = j(\rho c/S_s) \sin kl_s'$ given from equation (6).

4.2 Test Method

In the acoustic test, difference between noise levels of the exhaust pipe without the muffler ($l' = 175$ mm) and that with the muffler is measured, to indicate attenuation. The sound pressure level measuring point is fixed at a given position from the exhaust system outlet.

A pure tone, white noise and exhaust noise from the vehicle are selected as sound sources, and investigation is performed including the evaluation (weighting) method for the acoustic attenuation-distance characteristics.

4.3 Test Results

4.3.1 Pure Tone Test and Band Noise Test

The acoustic attenuation-distance characteristics of the 1/3-octave band noise, using white noise as a noise source, matches well with the characteristics of a pure tone up to approx. 500Hz, when compared

In the simple models shown in Fig. 1.

Over a band to approx. 8KHz. distribution of actual exhaust noise spectra is close to that of white noise having considerable power. In the case of indication of the said characteristics of sinusoidal, its evaluation is difficult over a band exceeding 2KHz but if the characteristics of band noise is used, the evaluation guideline of the band can be obtained.

But spectral indication based on sinusoidal is required to accurately weigh the characteristics over a band of lower than 2KHz. It is desirable to choose the noise source considering its merits.

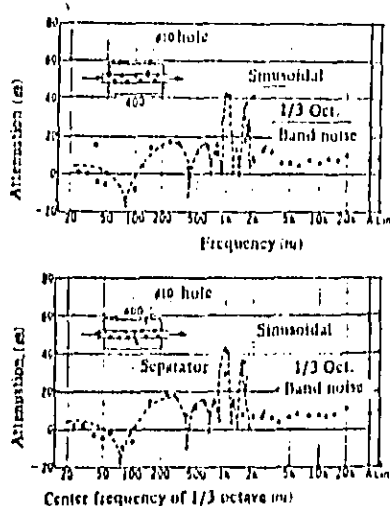

Fig. 1 Effect of test signals to attenuation character characteristic of mufflers

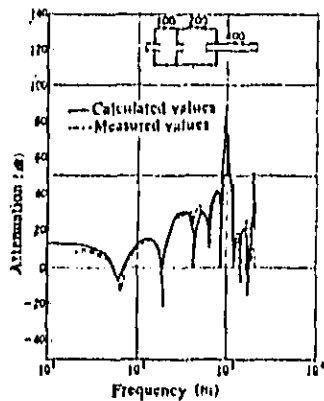

Fig. 2 Comparison of the measured and the calculated muffler attenuations

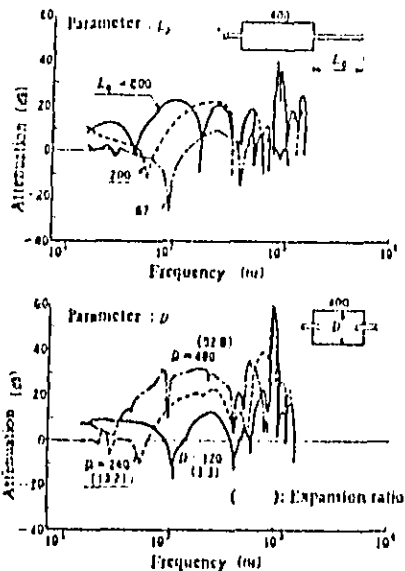

Fig. 3 Attenuation of muffler expansion chamber type

4.3.2 The relationship between Calculated Values and Measured Values

The relationship between calculated values and measured values of the fundamental elements shows almost satisfactory approximation. Combination of the expansion and resonance types is exemplified in Fig. 2 as a combination of the fundamental elements.

This shows that also in the combined models, coverage is excellent and that estimation of the attenuation characteristics is possible.

4.3.3 Characteristics of Fundamental Elements

(1) Expansion chamber type

From calculation of equation (4), the practical approximate equation to check a qualitative tendency in the expansion chamber type is as follows.

$$Att = 20 \log_{10} \left[\frac{S}{s} \frac{\sin kL}{\cosh kL_{11}} \frac{\sin kL_0}{\cosh kL_{01}} \right] \dots\dots\dots (7)$$

where

- S: Sectional area of the cavity
- s: Sectional area of the inlet and outlet pipes

In contrast, a qualitative tendency in parameter variations using the actual models is given as follows, and the typical examples are shown in Fig. 3.

- D (cavity diameter): The maximum attenuation is proportional to 20 log₁₀(S/s).
- L (cavity length): The number of passing frequencies increases as L is lengthened.
- L₀ (tail pipe length): It shows the same tendency as variation of L.
- L₁ (inlet pipe): The characteristics of the resonance type can be superimposed on those of the expansion type when L₁₁ and L₁₀ are lengthened.

(2) Resonator type

When the volume of the resonance chamber is represented by V and the area of the resonance hole by S_r, resonant frequency (f_r) of the resonator type is given as follows.

$$f_r = \frac{c}{2\pi} \sqrt{\frac{S_r}{L_r V}} \quad (c: \text{Sound speed}) \dots\dots (8)$$

Variations of the parameters with these factors are given below, and the typical example is shown in Fig. 4.

- L_r (cavity length): f_r decreases with an increase of V if L increases, and the number of pass frequencies which depends upon L also increases.
- L_r (resonant hole length): f_r decreases with an increase of L_r but attenuation does not vary.
- D_r (resonant hole diameter): The same tendency as in the expansion type is shown as D_p when D_r D_p is increases to some extent.
- l_r (position): No influence
- n (the number of resonant holes): f_r changes by √n-folds as n increases, and when it is further increased, the tendency becomes close to the expansion type (see Fig. 4).

(3) Perforated-pipe gas dispersion type (Multi-holes type)

This type has the same tendency as the expansion type with respect to the acoustic characteristics.

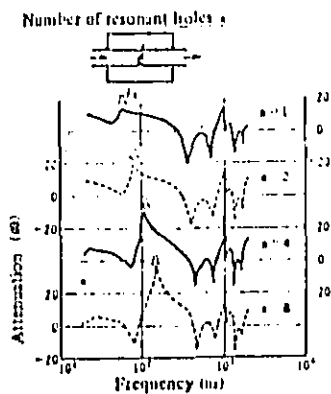

Fig. 4 Effect of number of resonant holes

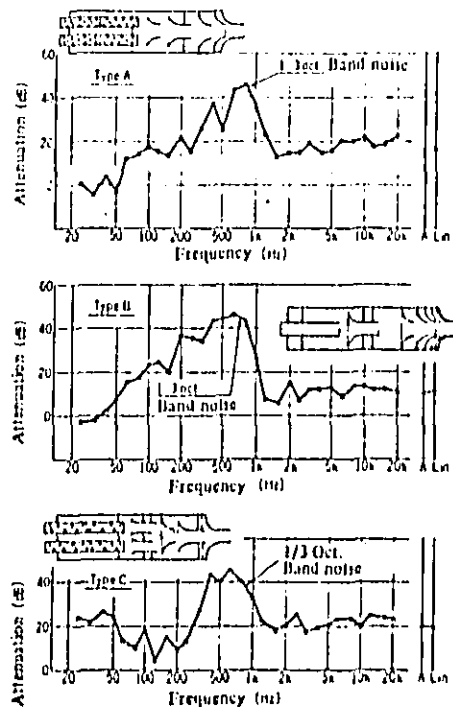

Fig. 5 Attenuation of various test mufflers for vehicles

With or without separator: No effect upon the acoustic characteristics (see Fig. 1).

D_p and n : Same as stated above.

The characteristics of the fundamental elements were mentioned above. Seeing the band noise characteristics, there is a tendency that the perforated-pipe gas dispersion type is larger than the expansion type in the attenuation characteristics over a band of higher than 2kHz.

4.3.4 Characteristics of Mufflers for Vehicle

The acoustic attenuation-frequency characteristics of a prototype muffler is shown in Fig. 5. It is found from the attenuation characteristics that the muffler showing extreme decrease at a particular frequency is disadvantageous. But the damping effect of the exhaust system includes complicated factors such as variation of acoustic attenuation due to the influence of the exhaust gas stream, so it cannot absolutely be weighed.

6. DRAFT NOISE TEST (FLOW GENERATED NOISE TEST)

5.1 Test Method

A rotary blower is used as a draft source, and steady air current is supplied to the exhaust system to be tested via the silencer. To measure draft noise, an anechoic box is used, a microphone is installed at an angle of 45° and a position of 50 cm from the exhaust port and a straight pipe is used for the evaluation standard. The test system block diagram is shown in Fig. 6.

5.2 Test Results

When steady air flow is sent to the exhaust system, power of draft noise which will be produced from the exhaust port can approximate to flow velocity as follows from data of types of muffler shown in Fig. 7.

- With $v < 50$ m/s, $PWL \propto (v^2)^2$
- With $50 \leq v < 100$ m/s, $PWL \propto (v^2)^3$
- With $v > 100$ m/s, $PWL \propto (v^2)^4 \sim 5$

5.2.1 Features of Fundamental Elements

(1) Expansion type

- (a) Draft noise level is 10 to 20 dBA higher than that of the straight pipe.
- (b) If a gap of the input/output insertion pipes is reduced, whistling close to the spectrum of a pure tone tends to be produced (see Fig. 8).
- (c) When the outlet insertion pipe is lengthened, draft noise increases (see Fig. 9).

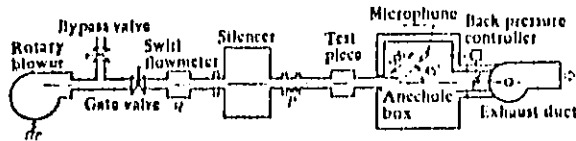

Fig. 6 Experimental layout for flow generated noise

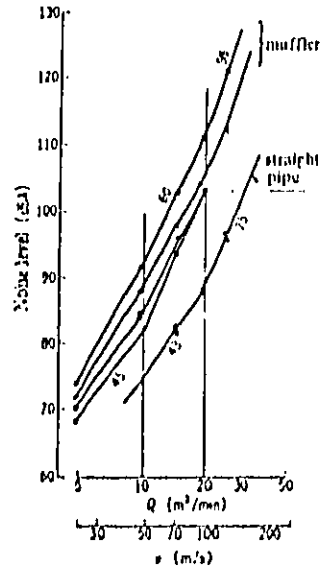

Fig. 7 Flow generated noise level under various mufflers

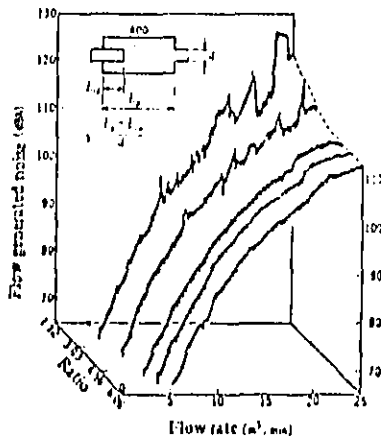

Fig. 8 Effect of the gap of inlet and outlet expansion pipe to flow generated noise

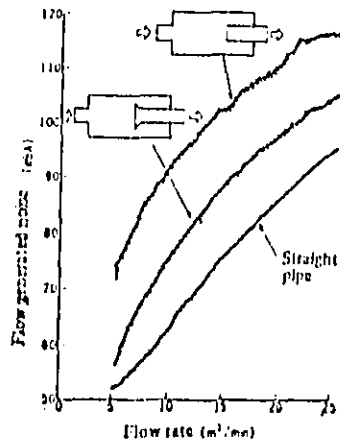

Fig. 11 Reduction of flow generated noise by horn type extension pipe

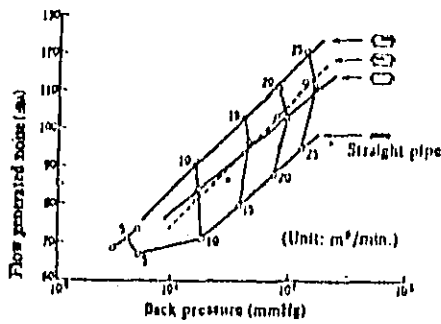

Fig. 9 Flow generated noise of expansion type mufflers

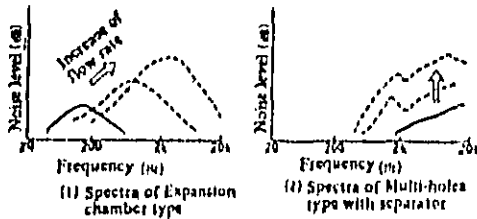

Fig. 10 Change of flow generated noise spectra by air flow rate

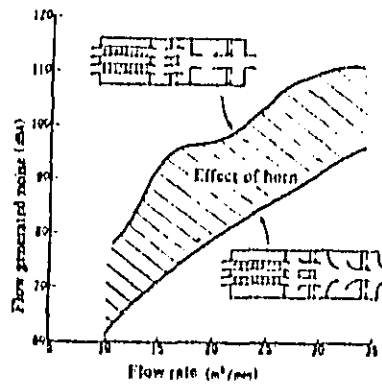

Fig. 12 Reduction of flow generated noise by horn type extension pipe of test muffler for vehicles

- (2) Resonance type
 - (a) When holes having a diameter of less than 10 mm are placed in two or three rows its noise level rise is 2 to 3 dBA as compared with the straight pipe.
 - (b) When an opening diameter exceeds 20 mm, extreme whistling is produced.
- (3) Perforated-pipe gas dispersion type
 - (a) When the separator is installed to this type, it is the same as the expansion type.
 - (b) Without separator, whistling tends to be produced.

The characteristics of the fundamental elements are given in Table 2.

5.2.2 Reduction of Draft Noise

It is considered that draft noise is produced due to such factors as vortex, convection, friction and resonance when high-speed exhaust gas flow passes through the muffler. Its spectrum is predominated by a high-frequency components as shown in Fig. 10.

As a reduction means, it is important first to select a muffler having low draft noise level, especially a hard-to-whistle element in the fundamental elements. As a very influential part of the internal component, the edge is important. In order to prevent the edge from getting too close to the core of the jet stream, the edge is made horn-shaped (referred to as with R) which greatly reduces flow generated noise.

Fig. 11 shows the effect of noise reduction in the expansion type, where the noise is reduced 10 to 20 dBA. When this is applied to the muffler for the vehicle, the effect shown in Fig. 12 is obtained.

5.2.3 Consideration of Back Pressure

Fig. 13 shows the back pressure-draft noise characteristics of the fundamental elements. Of the types, especially the perforated-pipe gas dispersion type with the separator is in question, and it is approx. 2 folds as many as the straight pipe in pressure loss. An increase of pressure loss is a fatal defect for this type. It is required to select a perforation rate of more than 1.5 as shown in Fig. 14. In practice, an effect of 40% reduction in back pressure is achieved by selecting a perforation rate from 1.5 to 3.0, 2 folds as many as the original one in the prototype muffler for the vehicle.

Comparison of attenuation, draft noise level and back pressure based on the straight pipe is shown in Table 2.

6. TESTS OF RADIATED NOISE FROM EXHAUST SYSTEM

6.1 Test Method

The schematic test system block diagram is shown in Fig. 15.

In this test, the exhaust system on the vehicle is vibrated on a base to investigate the vibration response characteristics, and radiated noise from the pipe wall is typically measured on a close location mainly to investigate the correlation between vibration and noise. For that reason, normal sine-wave vibration and random vibration close to the conditions of running vehicle are selected.

6.2 Test Results

6.2.1 Shaker Test Result

Disturbance which the exhaust system suffers from the engine is 15 G in maximum at the exhaust manifold, and its predominant component ranges from 300 to 2,000 Hz. When random vibration is applied based on white noise of the exhaust system, a spectrum of each part obtained is almost similar to a spectrum seen while the vehicle is running. A spectrum example under vibration is shown in Fig. 16.

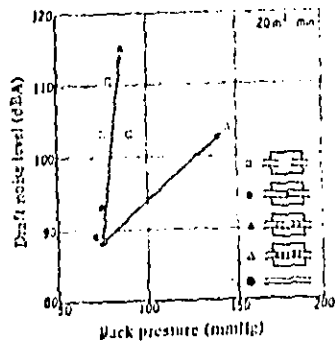

Fig. 13 Relation of flow generated noise and back pressure of typical muffler elements

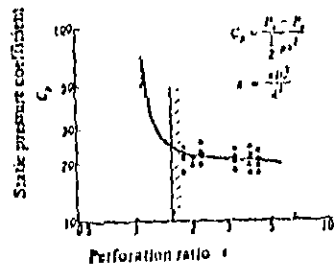

Fig. 14 Static pressure coefficient vs. perforation ratio

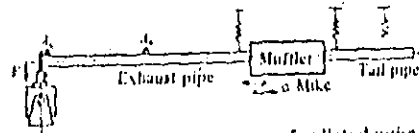

Fig. 15 Testing system of radiated noise from exhaust system

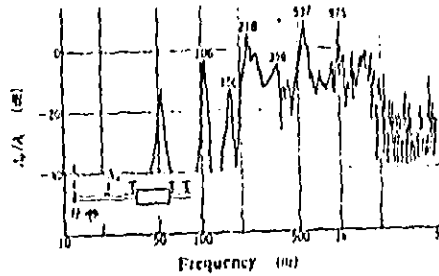

Fig. 16 Vibration response of exhaust system (Random excitation)

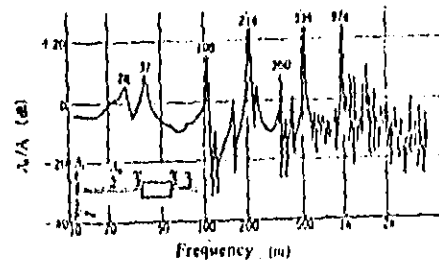

Fig. 17 Vibration response of exhaust system (Sinusoidal excitation)

Table 2. Rough characteristics of fundamental muffler elements

		Straight pipe	Expansion chamber type	Resonator type	Multi-chamber type	
					(Separator installed)	(Separator not installed)
Attenuation (dBA)		0	4 to 6	4 to 2	8 to 9	7 to 8
Draft noise	Level (dBA)	0	15 to 20	2 to 3	10 to 20	13 to 25
	Whistling	None	Small	Middle	None	Large
Back pressure (%)		100	130	106	210	116

The prominent peaks which appear in the spectrum depend upon resonant oscillation particular to the system. The response acceleration ratio, obtained by the sine-wave vibration, more prominently proves this fact. The comparison is shown in Fig. 17.

These peak frequencies often approximately correspond to calculated values of proper oscillation of the model system (see Table 3).

Table 3 Measured and calculated resonant frequencies of exhaust system

	Measured values		Calculated proper values
	Random excitation	Sinusoidal excitation	
1st	-	-	7.2
2nd	50	37	44.8
3rd	106	108	125.3
4th	218	214	245.3
5th	356	360	410.2
6th	537	534	604.3
7th	975	974	843.0

(Unit: Hz)

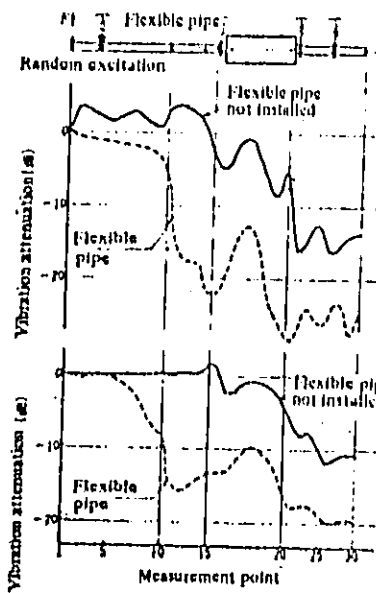

Fig. 18 Reduction of the radiated noise and the vibration of exhaust system by insertion of flexible pipe

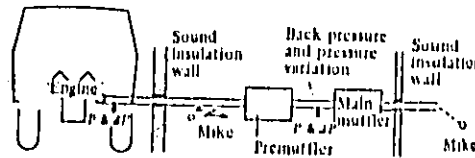

Fig. 19 Experimental layout for the test of exhaust system noise of vehicle

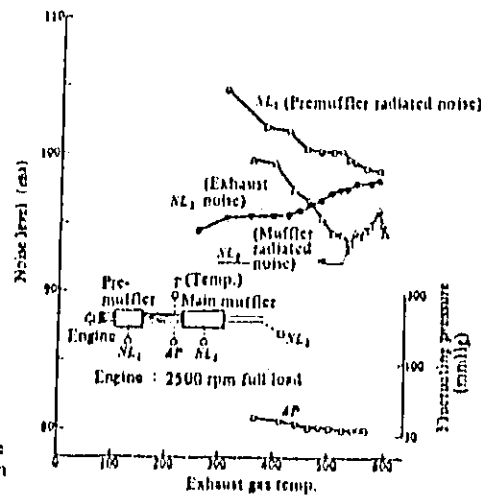

Fig. 20 Influence of exhaust gas temperature on exhaust system noise

6.2.2 Effects of Anti-vibration Elements

There are types of flexible pipe as anti-vibration elements which are applicable to the exhaust system. But almost all the elements do not satisfy conditions such as heat proofness, gas leakage, anti-vibration performance and durability. In this test, an interlock type flexible pipe (known as bellows) is used.

The relationship between vibration response and radiated noise of the exhaust system in random vibration is as shown in Fig. 18. In such an exhaust system model, there is almost no sound pressure attenuation in the exhaust pipe and its level tends to increase at the mid-section of the muffler cavity. But radiated noise can be reduced approx. 10 dBA by using the anti-vibration element, and its example is shown.

7. EXHAUST NOISE TEST ON VEHICLE

7.1 Test Method

To test exhaust noise and radiated noise from the exhaust system on the vehicle, an Eddy dynamometer having 300 PS is mounted to control engine output. The system, shown in Fig. 19, is used to measure only the noise from the exhaust system separating that from the engine noise.

For measurement, data are processed in online mode by the measuring vehicle which mounts a miniature computer.

The measurement procedure is shown in Table 4.

Table 4 Outline of Measurement Method

Type of test	Noise	Measurement method				Test condition
		Back pressure	Temperature (°C)	Acceleration	Varied pres.	
Sound	Mike position: 20 mm from exhaust port	-	Normal	-	-	(1) Input sound pressure: Constant (2) Sound source: (a) Sine wave (b) Random (c) Engine noise
Flow genoise	Mike position: 45°, 50 cm from exhaust port	50 mm before exhaust pipe	20 to 40	-	-	Flow rate: 0 to 30 m ³ /min.
Radiated noise from exhaust system	Mike position: 50 mm from pipe wall	-	Normal	g pick-up	-	(1) Vibration input: 2 g rms (2) Oscillator: (a) Sine-wave (b) Random
Exhaust noise in vehicle	Mike position: 45°, 50 cm from exhaust port	(1) 100 mm from manifold outlet (2) 200 mm before manifold	(1) 100 mm from manifold outlet (2) 200 mm before manifold	-	200 mm before manifold	(1) Engine speed: 1,000 to 2,500 rpm (2) Load: 4/4
Radiated noise from exhaust system of vehicle	Mike position: 100 mm from pipe wall	As stated above	As stated above	g pick-up	As stated above	As stated above

7.2 Test Results

As compared with the fundamental study of sound, draft noise and radiated noise mentioned above, when studying the actual vehicle, one must also consider the effects of exhaust gas flow containing exhaust pulsation and of temperature.

7.2.1 Exhaust Noise from Vehicle

During measurement of noise from the exhaust system on the vehicle, a factor to make the measurement difficult is variation of exhaust gas temperature. Fig. 20 shows variation of exhaust system noise with temperature. Spectra of exhaust noise and radiated noise under that condition are shown in Fig. 21. Exhaust noise level increases with temperature rise. This is probably due to the increase of flow generated noise caused by increased exhaust gas flow rate. In the meantime, radiated noise tends to lower in level with temperature rise.

7.2.2 Reduction of Vehicle Exhaust Noise

Fig. 22 shows the relationship between exhaust noise reduction and back pressure in combination of the prototype exhaust systems which have been fabricated for trial this time.

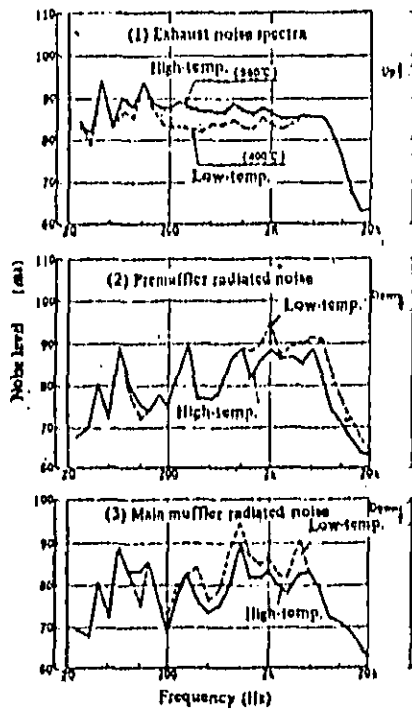

Fig. 21 Influence of exhaust gas temperature on exhaust noise spectra

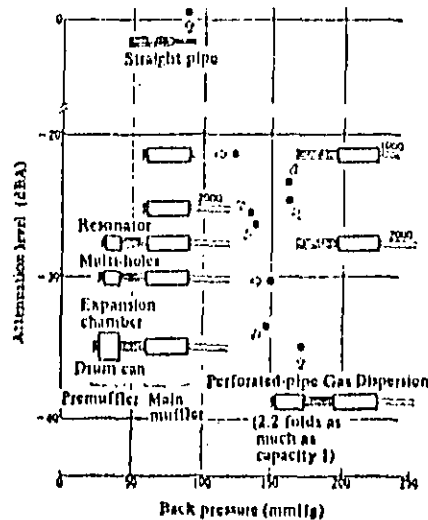
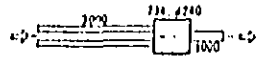

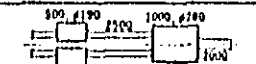
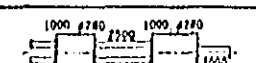

Fig. 22 Relation of exhaust noise reduction and back pressure of various exhaust system arrangements

REF ID: A611 481 5 0000

Table 5 Performance of the typical exhaust models

Engine at 300 PS/2,500 rpm

Typical model	Vehicle					Bench		
	Exhaust noise	Exh. Manifold, before muffler	Exh. Manifold, after muffler	Pre muffler	Muffler	ΔP (cm)	Sound (dB(A))	Drain noise (dB(A))
I 	0 (106.3)	0 (157)	0 (101)	0 (97.4)	0 (104.2)	0	16	0 (104.3)
II 	-3.2	+6	-9	+2	-0.5	+2.0	20.3	-12.4
III 	-8.8	-7	-18	+3.2	-5.3	-4.8	20.3	-12.4
IV 	-12.4	+16	-20	+3.0	-12.3	-10.0	20.3	-12.4
Goal values	-8		60					

Type C, shown in Fig. 5, is used as the main muffler here. It is delicately affected by the tail and exhaust pipes, and thus it is important to select the most suitable length and elements when arranging them in the exhaust system.

The typical models selected and required layout for goal values for reduction are shown in Table 5. Model I is a reference model having a muffler capacity of 33.2 lit. (2.23 folds as much as displacement of the engine tested). Model II has a muffler capacity of 61.5 lit. which is about 2-folds as much as the reference model. Model IV is 3.7 folds as much as the reference model in muffler capacity.

It is known that to clear a reduction target of -8 dBA, a muffler capacity which is 2.7 folds as much as the reference model is required.

7.2.3 Radiated Noise from Vehicle Exhaust System

The vibration response characteristics of the exhaust system on the vehicle matches well with that of bench test mentioned above. As far as radiated noise level on the vehicle is concerned, attenuation in the muffler is poorer than the bench test as shown in Fig. 23. This is estimated that radiated noise from the exhaust pipe close to the muffler, and also from exhaust pulsation is amplified and transmitted. For

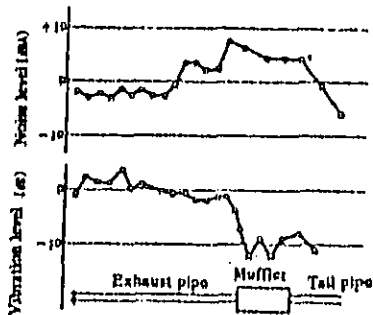

Fig. 23 Example of radiated noise from exhaust system of vehicle

that reason, the flexible pipe which provided a reduction effect of more than -10 dBA for radiated noise in the bench test provides only -2 to 4 dBA in this case.

As an effective measure for radiated noise, there is lagging. A lagging effect of 10 to 15 dBA is provided by a heatproof anti-vibration material ($t = 25$ mm) and iron sheet ($t = 1.0$ mm) but lagging is unavoidable when a radiated noise measure is essential.

8. CONCLUSION

The following guide lines were obtained for noise reduction of the exhaust system on the diesel-engine vehicle through this study.

8.1 Acoustic Characteristics

A spectrum of exhaust noise without the muffler is almost close to that of white noise, and a component in engine combustions over the low-frequency region varies 2 octaves or so in the engine speed range. For that reason, it is ideal that the attenuation spectrum required for the muffler is flat over almost the entire frequency region and that attenuation level is high.

But it is impossible in practice to obtain the characteristics which are almost flat in the restricted size range of the exhaust system. In this test, it is considered better that the perforated-pipe gas dispersion type providing comparatively high attenuation in the high-frequency region and the expansion type to permit high attenuation at lower than 1 kHz should be combined together, and that the region which will need more attenuation even in this combination should be covered by the resonance type.

8.2 Draft Noise

It is desirable to avoid as much as possible the use of elements which tend to produce draft noise, and shape the outlet insertion pipe to a horn when the expansion type is used. When using the perforated-pipe gas dispersion type whether the separator is installed or not, consideration must be taken to do so at the prestage of the muffler.

8.3 Radiated Noise

It is found that of types of noise from the exhaust system, noise radiated from its outer wall occupies a large share, and that it is not negligible in noise measures. It is also qualitatively proven that exhaust pulsation does greatly affect the level of radiated noise, and that in relation to this, mounting of the pre-muffler is effective to reduce radiated noise.

Shut-off of transmission of engine vibration to the exhaust system and lagging effects are ascertained as counter-measures for radiated noise, but many problems still remain in practical durability and reliability.

The influence of rigidity of the exhaust system upon radiated noise and transmitting noise characteristics were not covered by this investigation, and these will have to be solved through farther research.

8.4 Back Pressure

As far as back pressure in the exhaust system is concerned, pressure losses in the exhaust pipe are larger than in the muffler. It is important in design to increase the diameter of the exhaust pipe and take a large radius of curvature at the bending sections when piping.

To reduce pressure losses in the muffler, it is required for the perforated-pipe gas dispersion type to secure a perforation rate and for the expansion type, to design a horn-shaped outlet insertion pipe design.

Reference Literature

- (1) P.O.A.L., Davies, R. J. Alfredson, Design of Silencers for Internal Combustion Engine Exhaust System
- (2) Fukuda and Okuda, Mechanical Society Magazine, 72-604, May 1969
- (3) Tsutomu Kanai, NLR-12, June 1959

METHOD AND APPARATUS
FOR
MEASURING MUFFLER PERFORMANCE

Peter Cheng
STEMCO MFG. CO.
Longview, Texas

The measured quantity in our test facility is not the transmission loss nor insertion loss, but the pure exhaust noise under conditions simulating those specified by state and federal truck noise laws.

The tool to evaluate the pure exhaust noise is a bench test conducted at a test facility where total isolation of all other noise sources is feasible. The cross section of exhaust noise test lab is shown in Fig. 1.

The installation features an underground structure to mount test engines and water brake dynamometers. This structure serves to isolate the mechanical and air intake noises from the exhaust noise. All the exhaust from the test engine is piped directly above the ground to the muffler. The exhaust pipes are positioned in a manner as close to that found on the vehicle as possible.

The site was chosen for its compliance with SAE specification for stationary and drive-by test. That is, it is an open space test site with no nearby reflecting surfaces. Typical ambient sound level is below 50 dB(A), well below the measured levels. The height of microphone and separation between microphone and muffler is specified as 4 ft. and 50 ft. respectively, so that the measured exhaust noise level would be about the same as that from a moving truck undergoing a drive-by test per SAE J-366b procedure.

Before the testing modes are introduced, let us review briefly thru Fig. 2 the drive-by test per SAE 366b.

The vehicle under test approaches point A with 2/3 of the rated engine rpm and begins acceleration at point A under wide open throttle so that the rated engine rpm can be reached somewhere within the end zone.

To simulate the vehicle test conditions, three test modes are conducted.

- (A) Steady state mode
- rated engine speed and full load
- (B) Varying speed full load mode
- engine speed slowly varied from rated speed to 2/3 of rated speed at wide open throttle
- (C) Acceleration mode - accelerate the engine from low idle to governed speed until the engine speed stabilizes and return to low idle by rapidly opening and closing the throttle under no load conditions.

Modes (A) and (B) clearly have the drive-by test in mind. Mode (C) simulates the stationary vehicle noise test.

(2)

The "sound level rating" in Stemco aftermarket catalog is the highest recorded pure exhaust sound level measured in above mentioned test modes.

The "sound level rating" defined above may be too conservative in many cases. To illustrate this point, three hypothetical cases listed below will be examined.

Engine Speed(rpm)	Sound Level (dBA)		
	Muffler A	Muffler B	Muffler C
2100(rated)	71	71	71
1900	73	73	73
1400	75	70	77

In the case of Muffler A, the peak value of 75 dBA at 1400 rpm (2/3 of rated rpm) may not be a factor in the drive-by test. The distance between the microphone and point A is 70.7 ft. instead of 50 ft, and usually other noise sources do not peak until at higher rpm's. Muffler A and B may yield identical total vehicle noise per drive-by test. On the other hand, the peak level at 1400 rpm in Muffler C's case may indeed affect the total vehicle noise in drive-by test. A peak value at 1900 rpm or 2000 rpm may also be important because the vehicle would be close to point B in Fig. 2 and be right in front of the microphone.

It is therefore difficult to use one dBA level to correlate bench test results and drive-by test results without being either too liberal or too conservative. But to a large extent, muffler designers can usually use the bench test results and judge how the muffler will perform in a drive-by test.

STEMCO EXHAUST NOISE TEST FACILITY

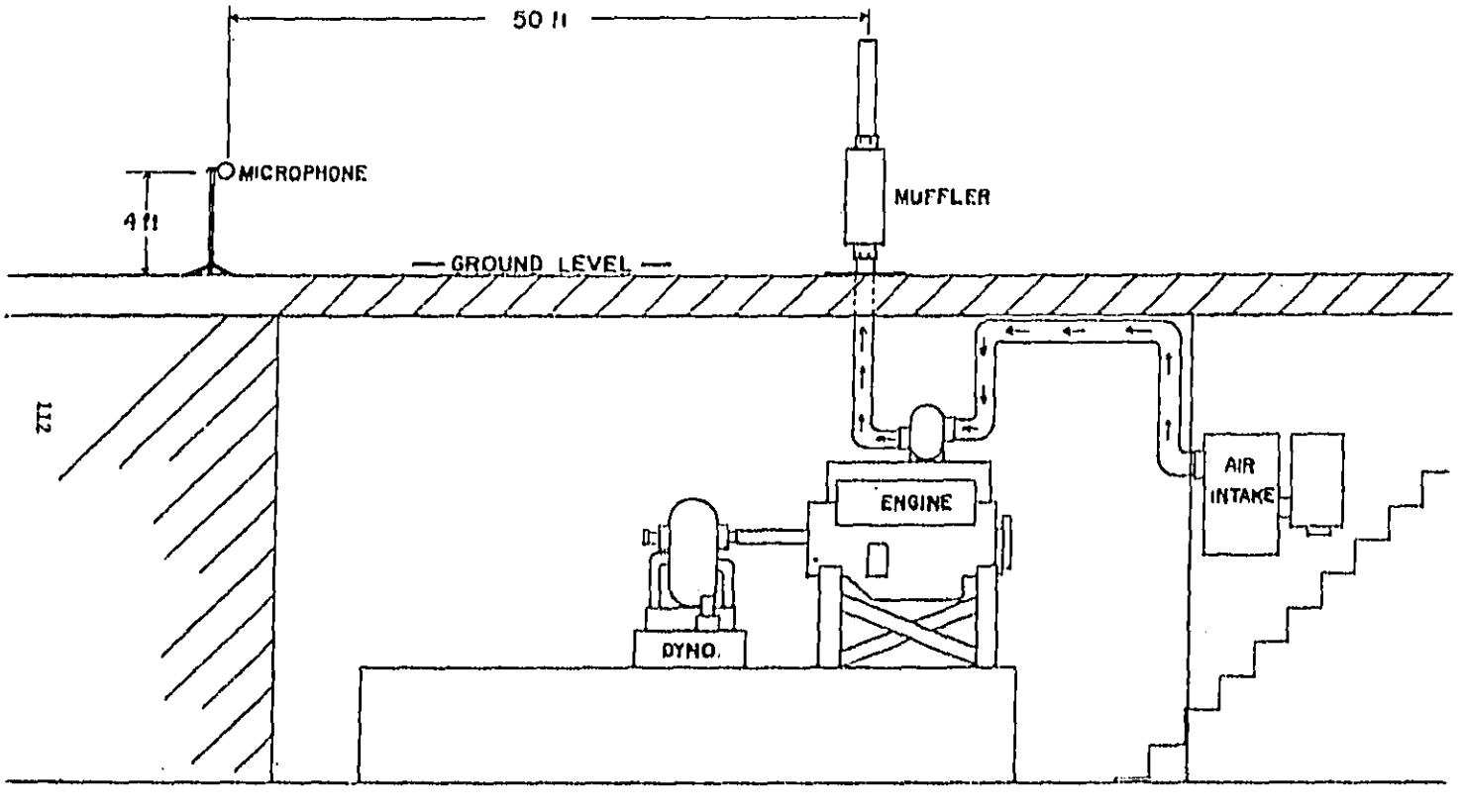

Fig. 1

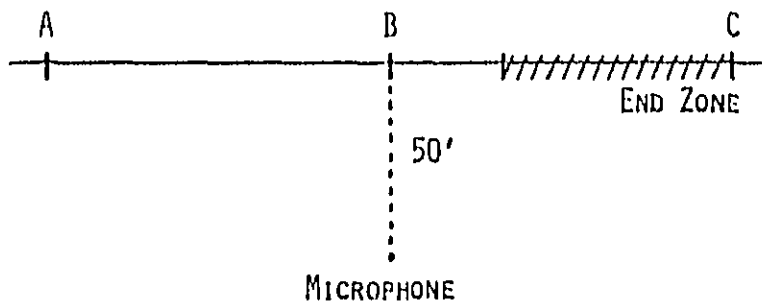

Fig. 2 Schematic Diagram of Drive-By Test Per SAE-366b

"OPTIMUM DESIGN OF MUFFLERS

by

D. Baxa^{*}, A. Baz^{**} and A. Seireg^{***}

University of Wisconsin
Madison, Wisconsin

- * Assistant Professor, Department of Engineering & Applied Science, UN-Ext.
- ** Research Associate, Mechanical Engineering Department
- *** Professor of Mechanical Engineering

Optimum Design of Mufflers

by

D. Baxa, A. Baz and A. Seireg
University of Wisconsin
Madison, Wisconsin

Abstract

This paper describes a computer based-design procedure for selecting the optimum configuration of automotive reactive mufflers and acoustic silencers. The procedure utilizes a specially developed scheme that predicts the pressure histories, and accordingly the accompanied attenuation or amplification of the noise level, resulting from the simultaneous reflection and transmission of sound waves propagating through variable impedance exhaust tubes.

The developed procedure is general in nature and can be used for synthesizing the optimal configuration of mufflers for any given operating parameters and design objectives.

Several examples are given to illustrate the optimum muffler configurations necessary to minimize the transmission of noise level at different working conditions. The examples demonstrate the potential of the developed procedures.

The described computer aided design approach can be readily applied for different patterns of exhaust pressure waves, mufflers with excessive temperature gradients and wall frictional losses as well as any other operating conditions and design objectives.

Introduction

The continuously increasing demand for high performance internal combustion engines has forced the automotive engineers to raise considerably the cycle pressures and the engine speed. Such modifications have contributed considerably to the increase of the exhaust noise level to the extent that it became a major environmental pollution problem. Consequently, efforts have been exerted to develop several forms of exhaust silencing systems in order to meet the severe requirements of the noise pollution statutory limits without reducing the engine performance. Realizing the importance of developing better mufflers the automotive industry in the USA is expected to spend \$16. to \$100. per car to meet the 1978 noise pollution standards [1]*. Such figures will definitely be higher in years to come to meet the growing need for cars with better handling, i.e. with low center of gravity, and therefore with very limited space for the exhaust systems. With the emission control components, the muffler designer will, thus, be under pressures to develop even more efficient and compact silencing systems.

The development of automotive mufflers has generally relied on empirical skills guided by past-experience and simple acoustic principles. Some design guides can be also found for simple muffler configurations as given by Magrab [2]. Only in the recent years has the development of automotive exhaust systems taken a more systematic and rational approach as can be seen in reference [2] to [6]. These efforts have presented different simulation techniques that utilize the wave propagation theory to predict the dynamic performance of reactive mufflers.

* Numbers between brackets refer to references at end of paper

The validity of the developed muffler simulation models has generally been tested either experimentally or against close-form theoretical formulas that are developed for simple muffler configurations. Common also among these studies is the fact that all have been used only to analyze the performance of reactive mufflers at different operating conditions rather than to devise means for selecting the optimum muffler that is best suited for a particular application. Few attempts [7,8] have been made to optimize the performance of mufflers but they were based on exhaustive-experimental search for the geometrical parameters or the properties of the lining materials for a muffler of a particular configuration.

The purpose of this study is to develop a computer-based design procedure to synthesize the optimal configuration of any reactive muffler for any given operating conditions and design objectives. The analytical procedure is based on a computerized one-dimensional wave propagation technique developed by Baxa and Seireg [3]. This technique is used to monitor continuously the reflection and transmission of pressure waves as they propagate through variable impedance exhaust tubes. Consequently, the pressure-time history at any location inside the muffler can be determined together with the accompanied degree of attenuation of the noise level.

This optimal design approach of mufflers will eliminate the exhaustive trial and error search for the best muffler for any given situation and therefore reduce the cost of development of the car's exhaust silencing system.

The optimization procedure used in this study is an adapted version of that developed by Wallace and Seireg [9] to optimize the shape of prismatic bars when subjected to longitudinal impact.

Computational Scheme for the Analysis of Wave Propagation in Mufflers with Step Changes in Impedance

The classical theory of one-dimensional wave propagation enables us to predict the pressure P at any location X and at time t by relating these parameters by the following eq :

$$\frac{\partial^2 P}{\partial X^2} = \frac{1}{C^2} \frac{\partial^2 P}{\partial t^2} \quad (1)$$

where C is the speed of propagation.

This theory assumes that there are small changes in the instantaneous density and consequently the instantaneous value is approximately equal to the average density ρ_0 , that the wave propagation is frictionless, the medium is homogeneous, and the sound levels are below 110 dB re 0.0002 microbar.

This equation has long been the basis for the analysis of one-dimensional transmission of waves and their reflections where changes in impedance occur. The evaluation of pressure variations in tubes can become more difficult as the number of impedance changes increases. However, with appropriate schemes, such as that developed by Baxa and Seireg [3], these problems can be conveniently and economically analyzed.

The following are some of the basic assumptions made in the developed muffler analysis program:

- (1) Pulse length is long compared with the tube diameter.
- (2) The source moves the entire cross-section with the same particle velocity.
- (3) Pressure fluctuation levels remain in the linear elastic region.

The first assumption implies that the wave would have a constant speed of propagation, which is determined by:

$$c = \sqrt{\frac{\gamma P_0}{\rho_0}} \quad (2)$$

where $\gamma = 1.4$; $P_0 =$ mean pressure; $\rho_0 =$ mean density. The second assumption indicates that the waves move as plane waves through the tube. Finally, the third assumption suggests that the waves and their reflected and transmitted components can be combined by superposition.

The time necessary for a disturbance to propagate through a tube segment of length L can be calculated from

$$t_p = L/c \quad (3)$$

In a complex tube comprised of many different segments (Figure 1), a propagation time is determined for each segment length. By comparing propagation times, a ratio of numbers K_1, K_2, \dots, K_n is determined from the following expression:

$$t_u = \frac{(t_p)_1}{K_1} = \frac{(t_p)_2}{K_2} = \dots = \frac{(t_p)_n}{K_n} \quad (4)$$

The significance of these integers is that it takes a wave K_1 units of time (where one unit is t_u) to travel the length of the first segment, K_2 units to travel the length of the second segment, etc. Because the propagation times are multiples of the unit of time, t_u , the initial wave and all reflected and transmitted waves will reach the interface at times which are some multiple of t_u .

Every section of the tube has an acoustical impedance which depends upon the mean density (ρ_0), the velocity of propagation (c), and the cross-section (S) of the pipe. The relationship is as follows:

$$Z = \frac{\rho_0 c}{S} \quad (5)$$

$\rho_0 c$ is often referred to as the characteristic impedance of the medium.

By considering the pressure and velocity equalities at the interface of a wave going from tube 1 to tube 2, it can be shown [10] that the transmission and reflection of the velocities are as follows:

$$U_R = \frac{Z_2 - Z_1}{Z_2 + Z_1} U_I \quad (6)$$

$$U_T = \frac{2Z_1}{Z_2 + Z_1} \frac{S_2}{S_1} U_I \quad (7)$$

where U_I , U_R and U_T are incident, reflected, and transmitted volume velocities, respectively; Z_1 and Z_2 are the impedances of the two tubes. Since pressure and volume velocity are related by:

$$P = U \rho_0 c / S \quad (8)$$

equations (6) and (7) become:

$$P_R = \frac{Z_2 - Z_1}{Z_2 + Z_1} P_I \quad (9)$$

$$P_T = \frac{2Z_2}{Z_2 + Z_1} P_I \quad (10)$$

When the density and velocity are constant,

$$P_R = \left(\frac{\frac{1}{S_2} - \frac{1}{S_1}}{\frac{1}{S_2} + \frac{1}{S_1}} \right) P_I = \left(\frac{S_1 - S_2}{S_1 + S_2} \right) P_I = c_R P_I \quad (11)$$

Where c_R is the reflection coefficient.

$$P_T = \left(\frac{2 \frac{1}{S_2}}{\frac{1}{S_2} + \frac{1}{S_1}} \right) P_I = \left(\frac{2S_1}{S_1 + S_2} \right) P_I = c_T P_I \quad (12)$$

Where c_T is the transmission coefficient.

Consequently, when the magnitude of the incident wave and the physical properties of the gas in the tubes are known, the transmitted and reflected portions of the wave can be determined from equations (11) and (12).

In order to analyze a general wave being emitted from the source, the physical properties and initial conditions of the source and of every segment of the tube must be known. These properties should include the impedance, speed of wave propagation, area, and length. In the case of a homogeneous gas the reflection and transmission coefficients can be reduced to a function of area only. The ratio of the propagation times must also be known. The initial

condition of the tube is considered to be that of no pressure waves inside. Therefore, it can be seen that knowing the parameters of area (S_i), length (L_i), static pressure of the gas (P_0), static density of the gas (ρ_0), and the ratio of the specific heat of the gas at constant pressure to that at constant volume (γ), one can determine the pressure history inside the tube. The wave propagation speed can then be determined from the relationship $c = \sqrt{\frac{\gamma P_0}{\rho_0}}$ or $c = \sqrt{\gamma r T}$, where r is a constant dependent on the particular gas and T is the temperature of the gas in degrees absolute. To determine the impedance of each tube segment, the density (ρ_0), the speed of wave propagation (c), and the area of each segment (S_i) are substituted in the equation $Z = \frac{\rho_0 c}{S}$. The propagation times are determined from the segment lengths and the wave propagation speed as $t_p = l/c$.

A ratio of integers is found from this array of propagation times, either by visual inspection or with the help of a computer program. Since it is assumed that each tube segment contains the same gas at the same pressure and temperature, the speed of wave propagation remains constant and the ratio of propagation times will be the same as the ratio of segment lengths.

Once all the physical properties and initial conditions are known, the pressure-time history can be determined as follows. After each unit of time, each interface is checked and the reflected and transmitted portions of the waves are calculated by using equations (11) and (12). All of the waves traveling in the same direction from an interface are summed. By knowing the magnitude of all the waves arriving at and leaving a given interface, it is possible

to construct the "pressure-time" history at every interface. This procedure is repeated for each unit of time until a steady-state condition is achieved.

The analysis scheme utilizes this approach and can be used in one of two modes. First, the response to a sinusoidal input can be determined and the transmission loss can be calculated in decibels for the entire system. In the second format, a general periodic pressure input can be read in and used to calculate the pressure responses of the system. This second approach is particularly useful in determining the effect of a tuned exhaust system on the pressure history.

The computerized routine is developed to include as many segments as can conveniently fit into the computer. Each segment corresponds to a particular portion of the muffler. It is also possible to set the source and termination impedance in order to investigate the effect of this variation on the system. If the source or end is completely absorptive, the areas chosen would have the same area as the connecting segment. If the source or end is completely reflective, the area chosen would be zero. A flow chart of the developed scheme is shown in Fig. (2) to illustrate its different features.

Strategy for Designing Optimum Mufflers

The design of a stepped-configuration reactive muffler for attenuation of exhaust noise levels is formulated as an optimal programming problem. The major considerations in this formulation are the identification of the decision parameters, the description of the constraints imposed on the design, the explicit statement of the objective and the development of a suitable search technique for locating the optimum design parameters.

Muffler Parameters

For the general case of a segmented muffler, as shown in Fig. (1), is subjected to general periodic pressure waves of known amplitude, frequency and temperature, then the system variables are: -

- a. number of muffler segments .. n
- b. Length ' L_i ' and area ' S_i ' of each muffler segment where $i = 1, \dots, n$
- c. Source and termination impedances.

It can therefore be seen that for the n segment - muffler the total number of system parameters is $(2n + 2)$. Some of these parameters are specified beforehand. The remaining variables represent the decision parameters and have to be selected within the constraints imposed on them in such a way as to provide the highest possible performance.

Explicit statement of Muffler design Objectives

An explicit statement of a merit criterion which accurately describes the designer's objective constitutes a very important matter since this criterion guides the search and determines the selection of the optimum values of the decision parameters.

Examples of the possible objective criterion for this class of problems are: -

- (a) Maximization of the noise transmission losses at the engine operating speed.
- (b) Maximization of the noise transmission losses over a wide range of engine speeds.
- (c) Maximization of the negative pressures developed during the suction stroke when using a tuned muffler.

Other design objectives can be used to guide the selection of the muffler design parameters in order to meet the requirements for any particular situation.

Search Method

The steepest ascent method is utilized to search for the optimum design parameters of mufflers in order to achieve the maximum attenuation of the noise level, or any other objective, associated with the incident pressure waves. The optimization method guides the search for the optimum parameters along the direction of maximum attenuation, or any other objective, by changing the value of each design parameter X_i independently by a small perturbation ΔX_i and noting the accompanied change in the noise level ΔU . The new value of the design parameter $X_{i,j+1}$ is determined from the old value $X_{i,j}$ according to the following relationship:

$$X_{i,j+1} = X_{i,j} + \lambda (\Delta U / \Delta X_i) \quad i = 1, \dots, M \quad (13)$$

where M is the number of decision parameters. λ is an optimally selected step size that controls the changes between points j and $j+1$.

If no improvement occurs, the parameter is varied in the opposite direction. If this also fails to produce an improvement in the merit value, this parameter is kept constant for this step and the value of the other parameters is changed in a similar way.

The details of the adopted optimization scheme are shown in the flow chart of Fig. (3) to indicate the means included for selecting the maximum step size without violating the constraints and for avoiding the termination of the search at regions where the attenuation level vanishes. Such features make the use of

the steepest ascent method very suitable for searching the complex design region of the mufflers because it is extremely sensitive to parameter changes.

Therefore, for regions where no sharp ridges exist in the contours of the objective criterion, this algorithm is equivalent to a gradient search. But for situations where a ridge exists in the design space the algorithm is in effect a univariate search.

Numerical Examples

The optimum design procedure is used to develop the optimum-muffler configuration necessary to maximize the attenuation of the noise level of a particular pressure wave with a frequency of 1000 Hz and flowing through the mufflers at a temperature of 70°F. The procedure is utilized to illustrate the effect of changing the number of segments of the muffler on the degree of optimum attenuation of the transmitted noise. Mufflers having a fixed length of 3 feet but with 3, 6, and 12 segments are considered to illustrate the potential of the procedure in optimizing muffler configuration.

In all the considered examples the design problem is formulated as follows: -

Find the areas of the segments S_i $i = 2 \rightarrow n-1$

To maximize the transmission loss .. $TL = 20 \log_{10} \left(\frac{P_{input}}{P_{output}} \right)$ db

such that $S_1 = S_{input}$

$S_{IN} = S_{output}$

$S_{min} \leq S_i \leq S_{max}$ (14)

$L_i = L_{f_i}$ $i = 1, \dots, n$

where each segment lengths L_i is equal to a given value L_{f_i}

In the above formulation the muffler designer can select the desired limits on the area and length of each muffler segment. Consequently S_{input} , S_{output} , S_{min} , S_{max} and L_{f_i} are fixed values specified according to the designer requirements.

In the following examples these limits are taken as follows: -

$$\begin{aligned}
 S_{input} &= S_{output} = 1 \\
 S_{min}/S_{input} &= 0.1 \\
 S_{max}/S_{input} &= 10 \\
 L_{f_i}/\lambda &= 3/n
 \end{aligned}$$

where λ is the wave length of the incident pressure waves

Example 1

Fig. (4) shows the results for a 3 segment muffler, as that shown in Fig. (4-a). The optimization procedure with a initial configuration will produce the configuration shown in Fig. (4-a). Such an optimal configuration results in a noise transmission loss of 10.3 dB as compared to the 5.09 dB loss produced by the configuration of Fig. (4-a). It is interesting to note that the area of the middle segment in the optimal configuration, has increased to reach the maximum allowable limit set by eqⁿ (15). This agrees with the common practice of single expansion chamber muffler discussed, for example, (2 and 3).

REST AVIATION LIBRARY

Example 2

This example illustrates the effect of changing the number of segments of the muffler on the noise attenuation while operating under the same conditions as in the previous example.

Fig. (5-a) shows that starting with the 6 segment muffler illustrated in Fig. (5-a-1) then the optimal configuration will be as shown in Fig. (5-a-11), and the noise transmission losses will be 9.6 dB which is a less efficient design than that produced by the 3 segment configuration of Fig. (4-b).

But if we start with the configuration of Fig. (5-b-1) then the optimum configuration illustrated in Fig. (5-b-11) shows a considerable improvement, nearly 24.3%, over the optimum 3 segment muffler. If we consider, however, the muffler configuration of Fig. (5-c-1) as the initial starting point for the optimization routine, then the obtained optimum configuration of Fig. (5-c-11) yields a considerable improvement of 61.4% over the optimum 3 segment muffler.

It can therefore be seen that increasing the number of segments of a muffler of a given total length, is expected to produce a considerable increase in noise attenuation.

Also, it is interesting to note that starting with different initial configurations does not produce the same optimum configuration. This is due to the complexity of the design space and emphasizes the need for optimization tools for designing mufflers and acoustic silencers.

Example 3

This example shows the improvement in noise attenuation resulting from increasing the number of segments of the muffler under consideration to 12 segments.

Fig. (6-a) shows the initial and the optimized configurations which result in a noise attenuation of 30.24 dB. This is almost three times as much as that of the optimum 3 segment configuration. This optimal 12 segment shape has been obtained in a single iteration by the developed optimization routine.

Fig. (6-a-ii) shows another optimal configuration which is a symmetrical arrangement of multi-connected expansion chambers.

If we consider the initial 12 segment configuration of Fig. (6-b-1) then the resulting optimal muffler will attenuate the incident noise level by 32.34 dB which is 6.94% better than that produced by the configuration of Fig. (6-a-ii).

Summary

The paper has described a computer-based design procedure for optimized configurations of reactive mufflers with step changes in their acoustic impedance when subjected to periodic pressure waves. The existence of multiple optimum configurations is evident by the dependence of the final design on the selection of the number of segments and the starting point of the search. The considered examples illustrate the potential of the developed computerized optimization approach as a powerful tool for synthesizing the optimal configurations of reactive mufflers.

Although the optimization in the considered examples is based on the maximization of the noise transmission losses at one frequency, the technique can be readily used to optimize the muffler design over a wide range of frequencies as well as optimizing the exhaust pipes for improved engine performance.

The procedure can also be applicable to situations where factors such as mean flow, frictional losses, temperature gradients, variable source and termination impedances should be considered in the design scheme.

References

1. Heath, R.A., "What's Ahead in the Automotive Muffler Field," Proc. of National Noise and Vibration Control Conference, Chicago, IL, June 1974, pp. 87.
2. Magrab, E., "Environmental Noise Control," J. Wiley and Sons, New York, 1975, pp. 215.
3. Baxa, D., and A. Seireg, "A Computer-based Procedure for the Analysis of Reactive Mufflers and Tuned Exhaust Systems," Proc. of NOISEXPO, 1977.
4. Davies, P.O.A.L., "Mufflers for Internal Combustion Engines," Proc. of Inter-Noise Conference, Denmark, 1973, pp. 143.
5. Karnopp, D., J. Reed, D. Margolis, and H. Dwyer, "Design and Testing of Reactive Mufflers," Proc. of Inter-Noise Conference, Washington, D.C., 1974, pp. 325.
6. Okda, J., "Performance of Reactive Mufflers and Calculation of Engine Exhaust Noise," Proc. of Inter-Noise Conference, Sendai, 1975, pp. 655.
7. Lykkeberg, P., "Design of Reflection Type Silencers based on the Theory of Reactive Acoustic Filters," Proc. of Inter-Noise Conference, Denmark, 1973, pp. 158.
8. Vér, I., "Design Optimization of Gas Turbine Silencers," Proc. of Inter-Noise Conference, Sendai, 1975, pp. 687.
9. Wallace, D., and A. Seireg, "Optimum Design of Prismatic Bars subjected to Longitudinal Impact," ASME Paper No. 70-DE-G, Trans. of ASME, J. of Engineering for Industry.
10. Kinsler, L.E., and A.R. Frey, "Fundamentals of Acoustics," Second Edition, J. Wiley and Sons, Inc., New York, 1962.

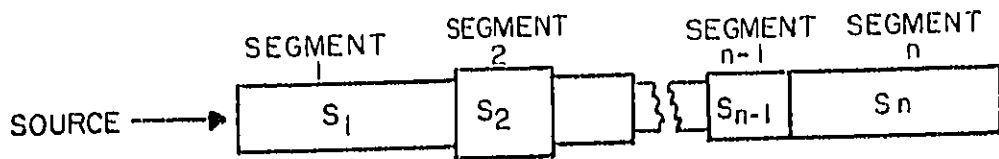

FIG. 1 — A TUBE WITH n SEGMENTS

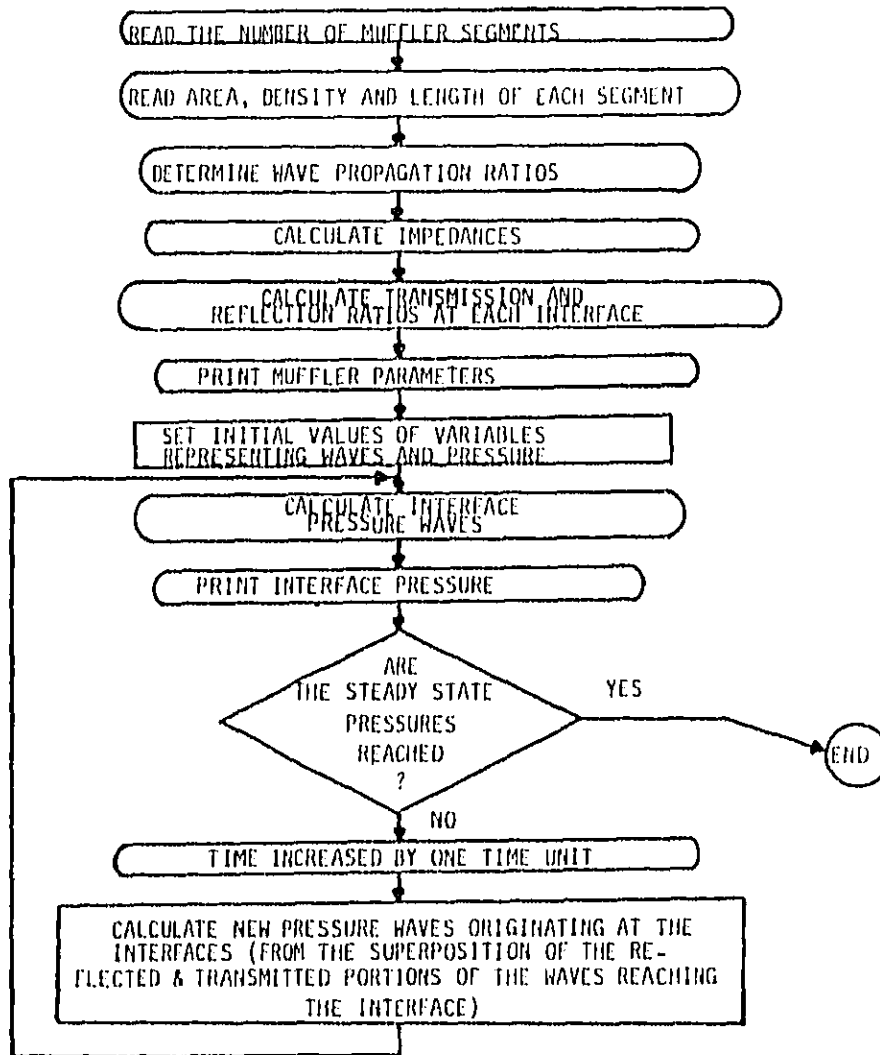

Fig. 2 Block diagram of analysis program

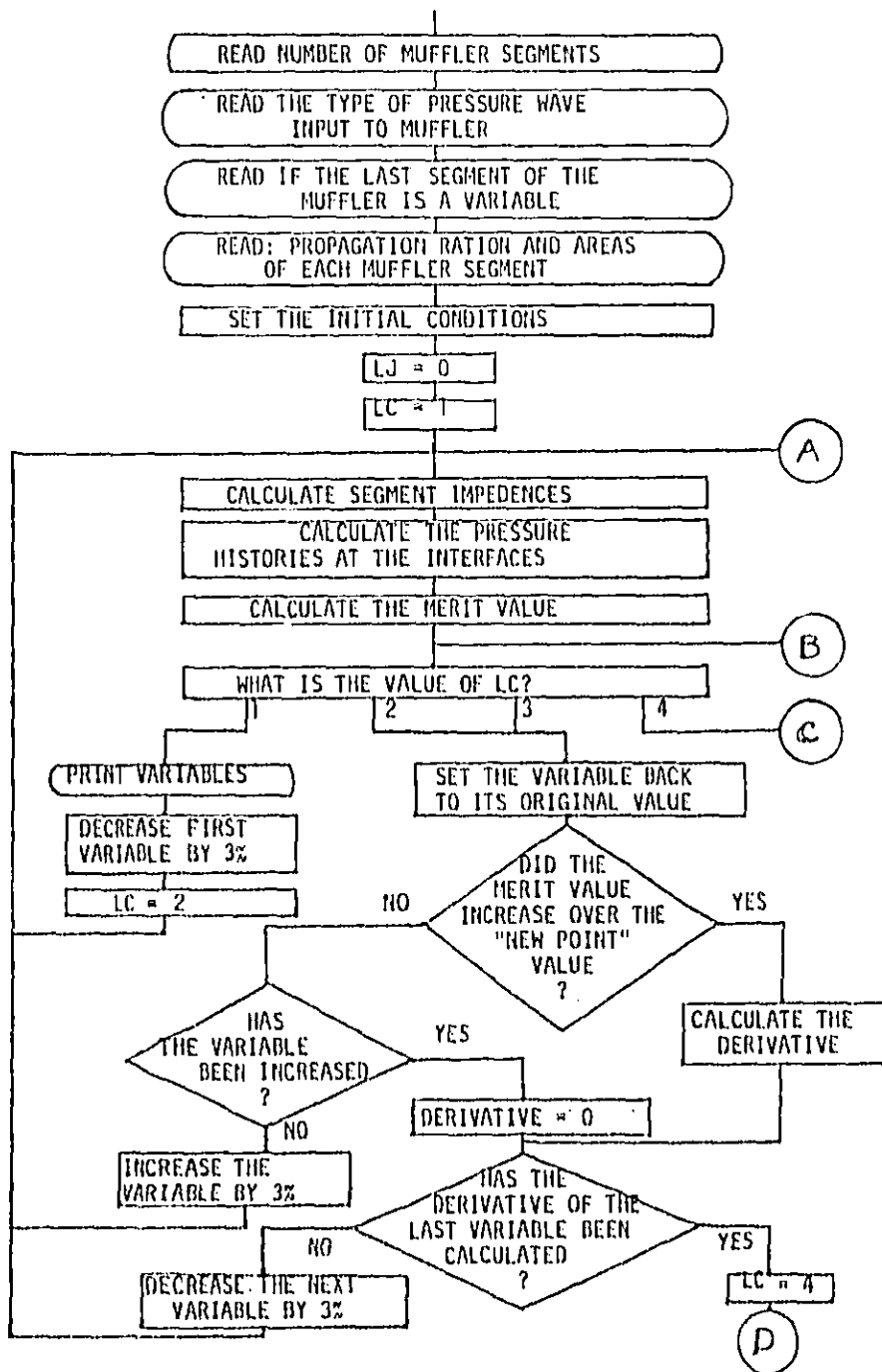

Figure 3

REST AVAIL ABN 5 7000

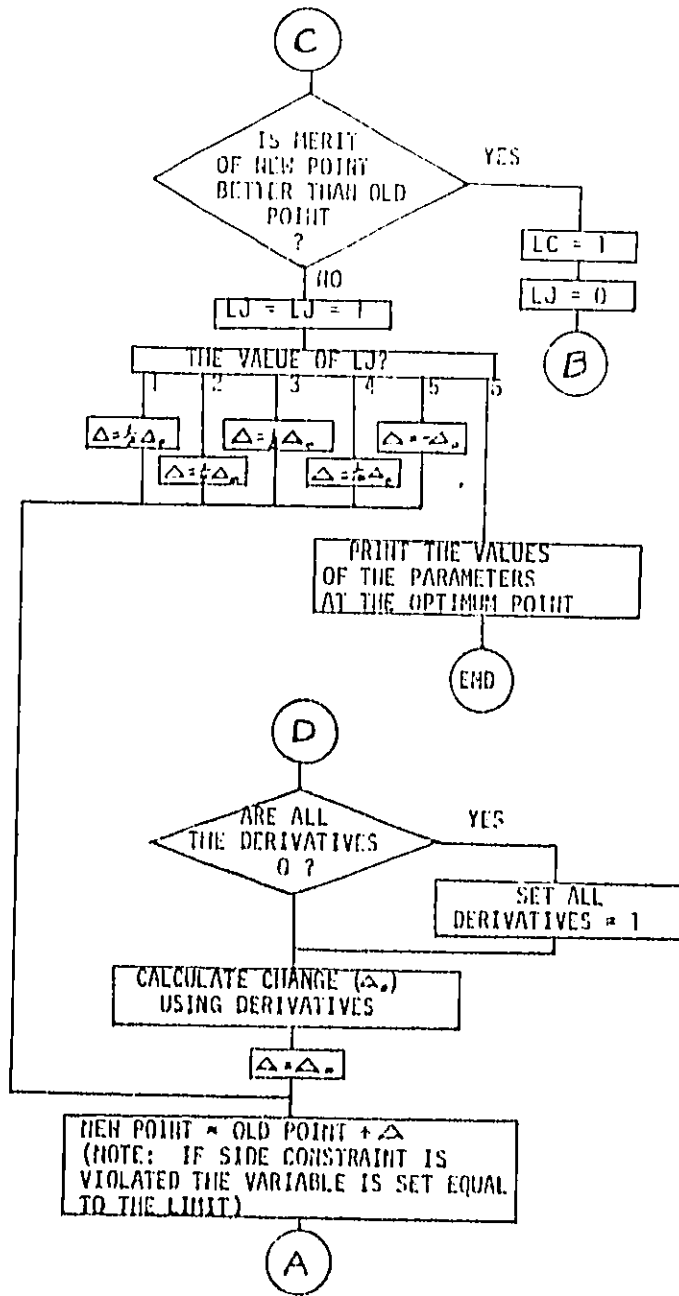

Figure 3 (Continued)

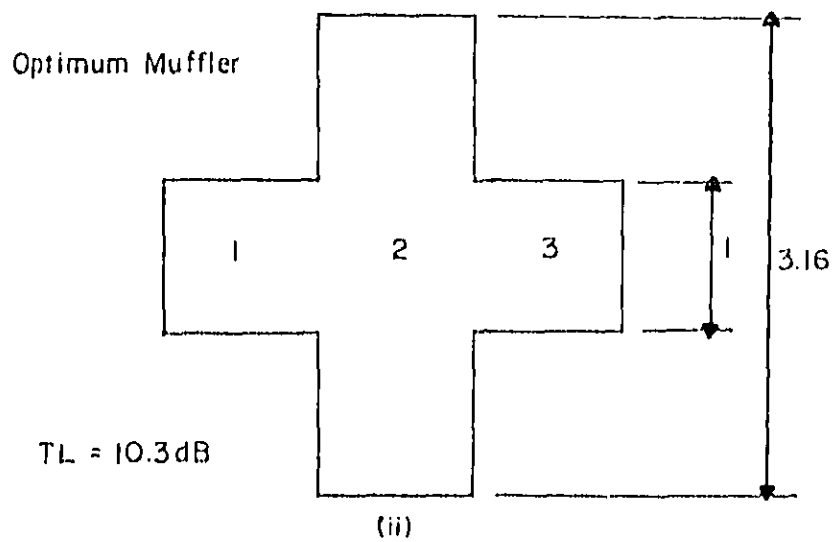
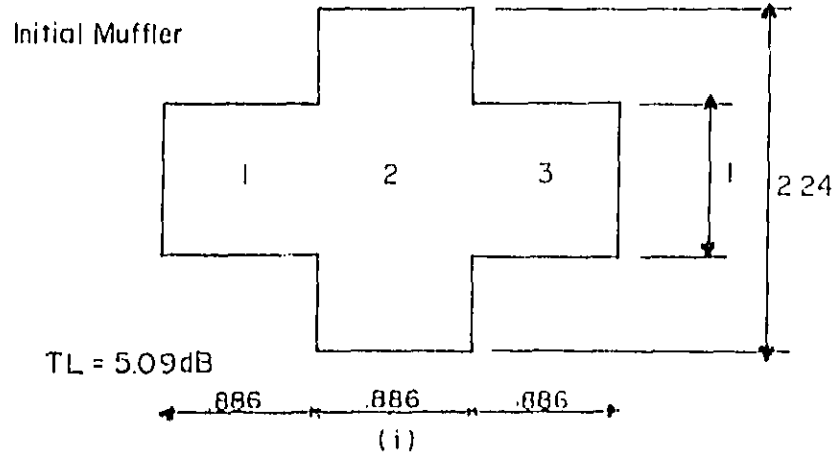

FIG.(4) Three Segment Reactive Muffler

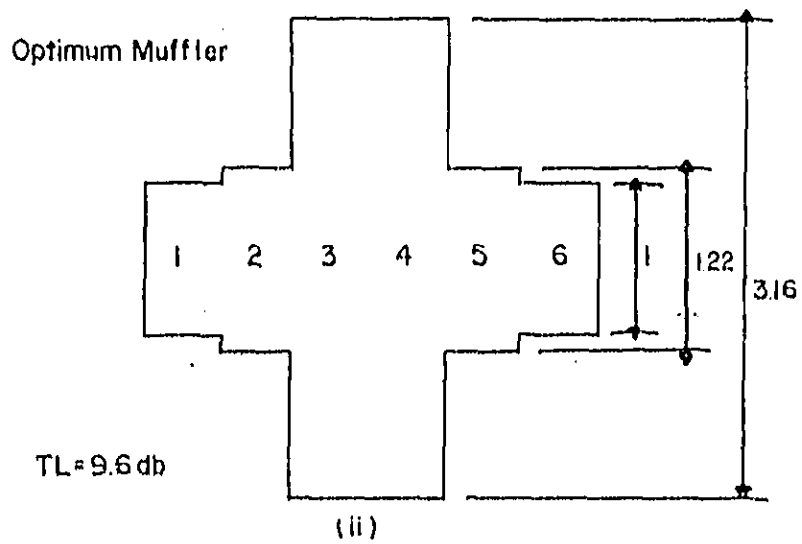
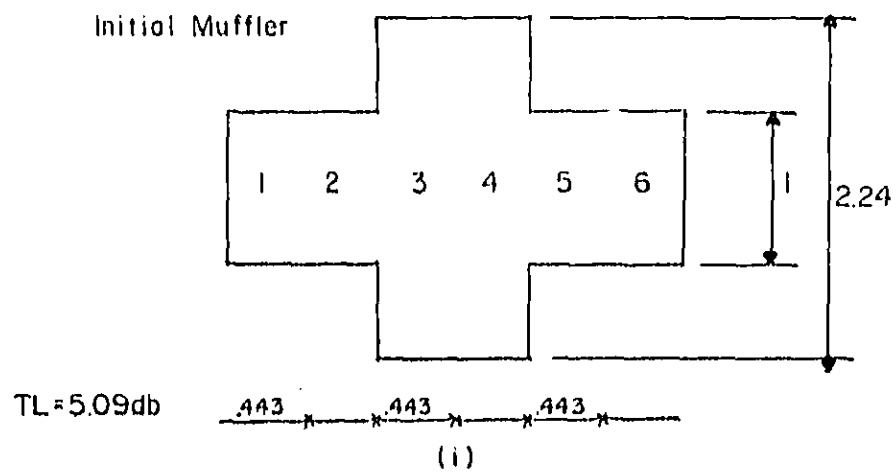

FIG.(5-a) Six Segment Reactive Muffler

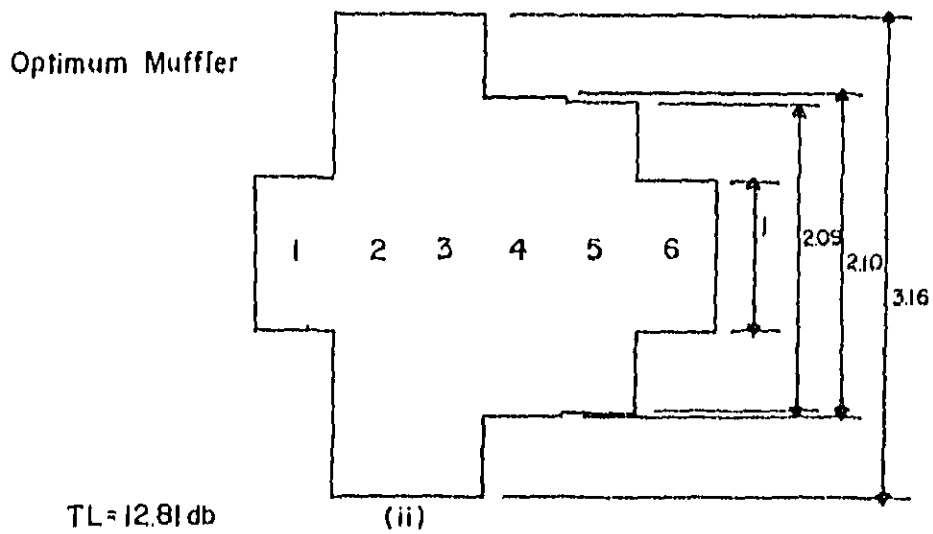
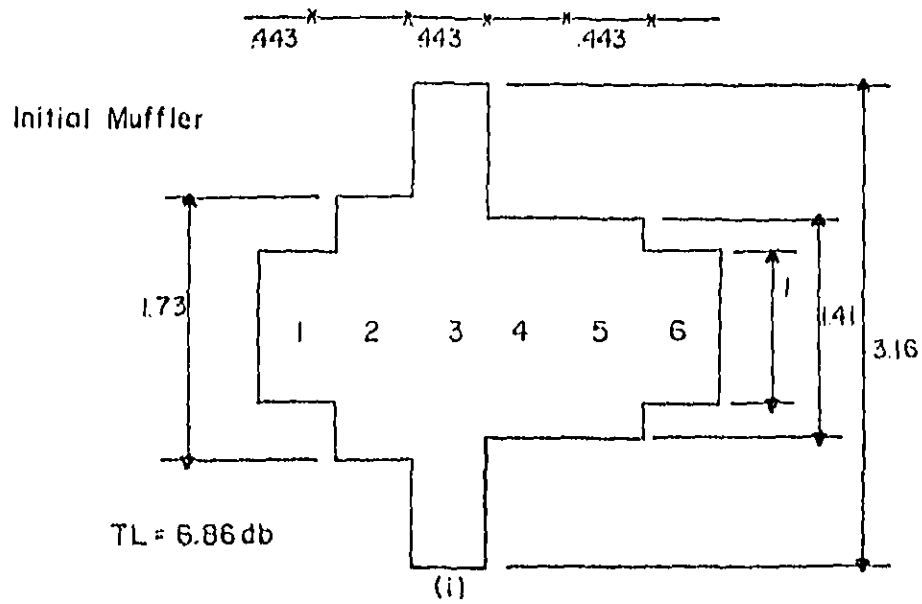
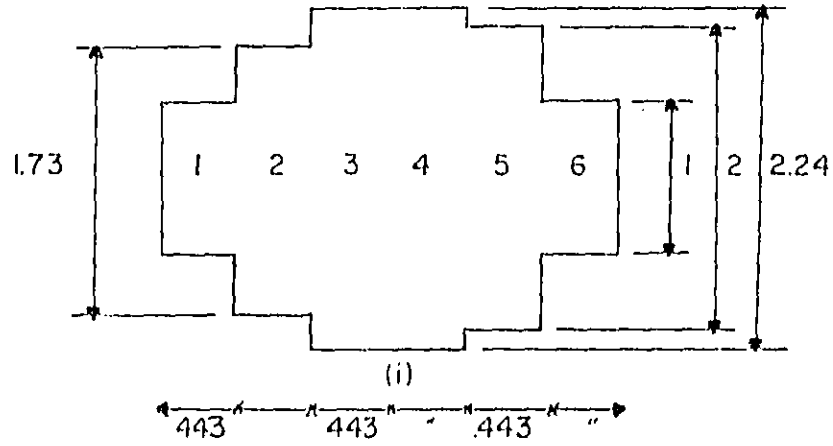

FIG.(5-b) Six Segment Reactive Muffler

Initial Muffler



Optimum Muffler

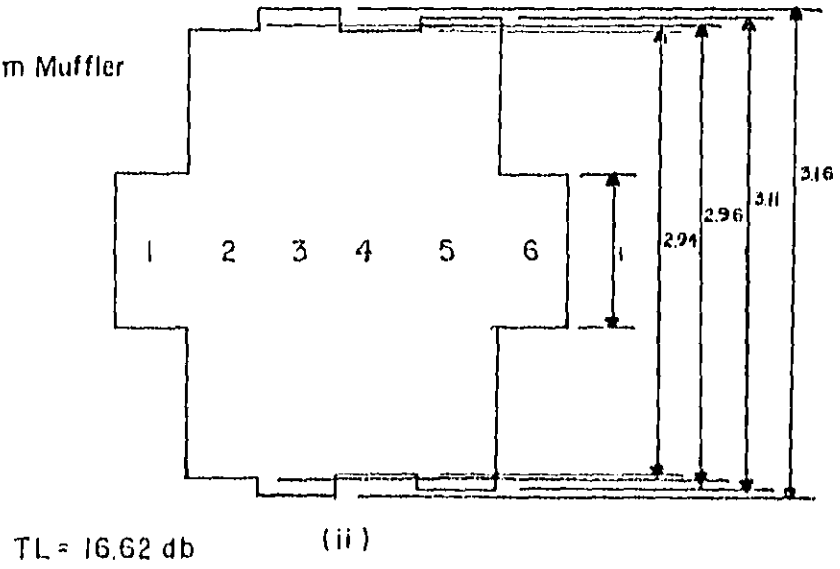
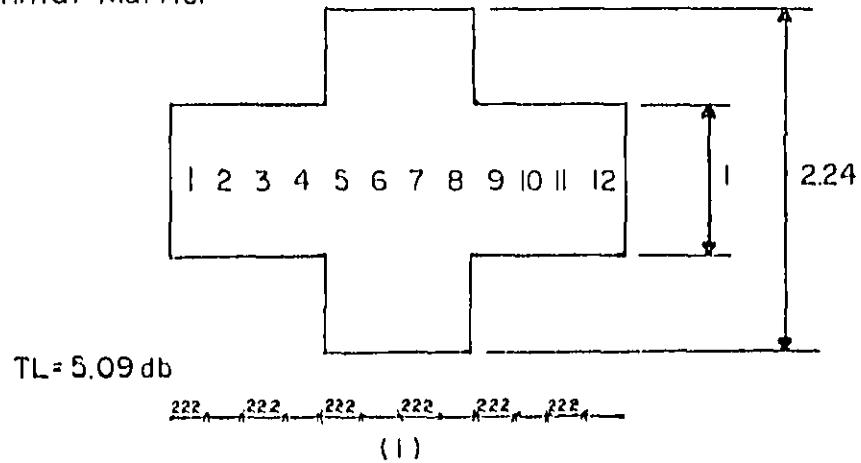

FIG.(5-C) Six Segment Reactive Muffler

Initial Muffler



Optimum Muffler

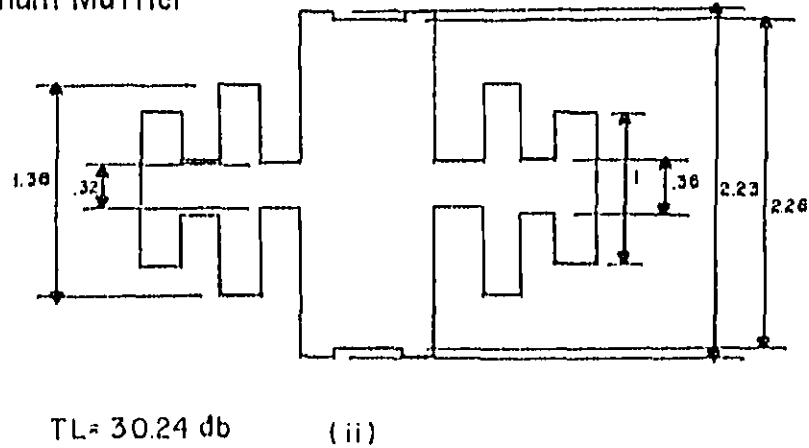
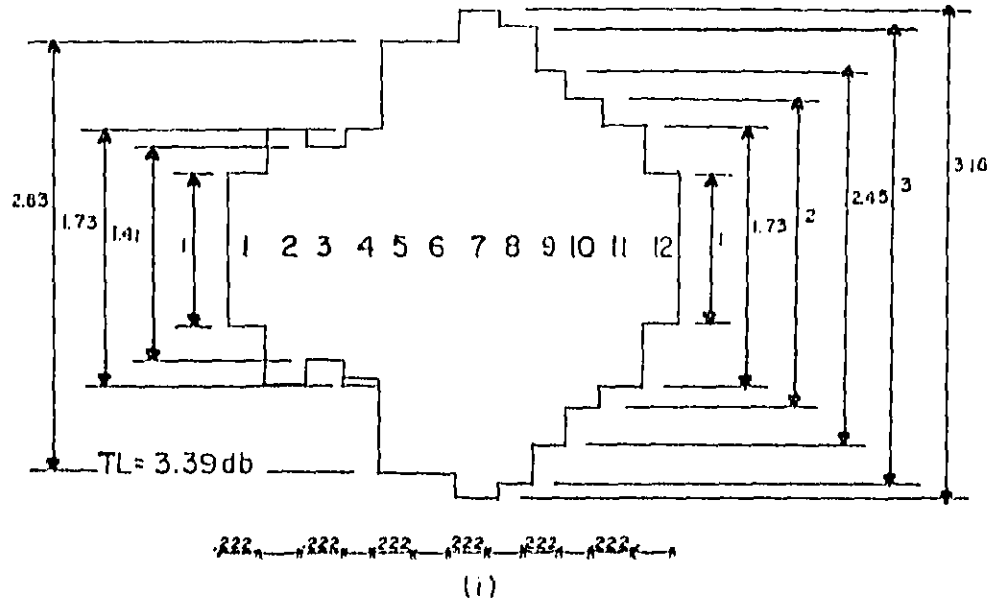

FIG.(6-a) Twelve Segment Reactive Muffler

RS-CT AVANT ARI E CONTY

Initial Muffler



Optimum Muffler

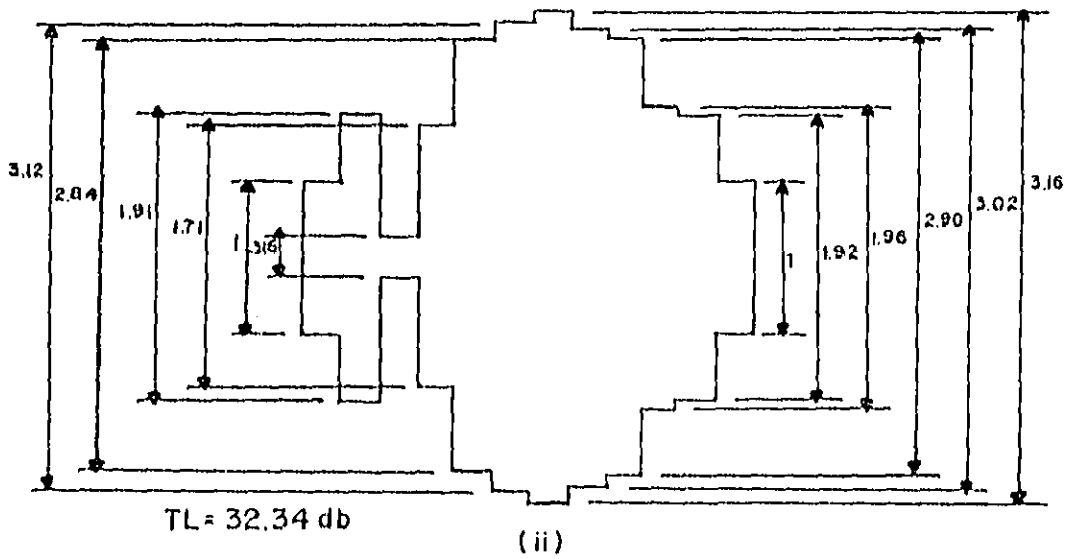

FIG.(6-b) Twelve Segment Reactive Muffler

BENCH TEST AND ANALOG SIMULATION TECHNIQUES FOR
ENGINE MUFFLER EVALUATION

by

Cecil R Sparks
Director, Engineering Physics
Applied Physics Division
Southwest Research Institute
San Antonio, Texas

Presented to:

Surface Transportation Exhaust System Noise Symposium
Sponsored by the U. S. Environmental Protection Agency

Chicago, Illinois
October 11, 12, 13, 1977

ABSTRACT

The problems associated with laboratory evaluation of engine mufflers are primarily those of (1) designing a facility which will provide a meaningful measure of muffler noise reduction, and (2) relating this physical (acoustic) data to the action of the muffler when placed on a specific engine exhaust system. While a wide-band siren can be designed to provide a suitable noise spectrum and source impedance, performance of any muffler must ultimately depend on the exhaust piping configuration into which it is placed. Experimental work in the 1960's at SwRI has shown that a bench test facility can provide useful acoustic data if the candidate mufflers are being evaluated for a relatively narrow range of engine applications, and a loudness evaluation technique was evolved which could reliably relate data from the bench test facility to performance (noise reduction) on an engine.

In addition, electronic simulation techniques have been evolved whereby the entire exhaust system (muffler, manifold, and piping) can be quantitatively evaluated on an electroacoustic analog. Although designed principally for simulating pulsation filters, this analog has been extensively used for simulating the exhaust systems of reciprocating engines, and for the design of mufflers specifically tailored for that engine, exhaust system, and range of operating conditions.

BENCH TEST AND ANALOG SIMULATION TECHNIQUES FOR ENGINE MUFFLER EVALUATION

BY
CECIL R. SPARKS

BACKGROUND

The problems associated with evolving a bench test procedure for evaluating the acoustic performance of mufflers lie chiefly in the fact that there's no such thing as an inherently good muffler. Regardless of muffler design, the NR afforded by any muffler is not a function of the muffler design alone, as the muffler is merely one part of a complex acoustic piping system. The "best" muffler for one engine may actually amplify noise from another.

Being a passive acoustic network, a muffler's performance (amplification or attenuation) depends not only upon its internal design but also upon its source and termination impedance (i.e., the attached piping), upon the spectral distribution and amplitude of the engine noise spectrum, flow rate, pressure drop and, of course, acoustic velocity (temperature and gas composition).

This is not to say that some muffler designs are not better than others for a given range of conditions, or that an optimum muffler cannot be designed for a specific set of conditions (and assuming a specific set of constraints on size, etc.), but as soon as engine operating conditions change, or the muffler is applied to a different engine, its performance can suffer markedly. Normally, muffler design is tailored to cover the range of engine operating conditions expected, and is designed as an acoustic low pass filter with a minimum of pass bands and the lowest back pressure (flow resistance) possible. These are, in fact, the major marks of a "quality" muffler.

The first step in seriously undertaking a program of bench testing, therefore, lies in defining the application and operating conditions for which the candidate muffler is to be evaluated. The more precise we can be in defining these conditions and the more narrow the variations in application and operating conditions are, the better job we can do both in designing a muffler and in bench testing it.

We at SwRI did a study some 12 - 15 years ago for MERDEC (then ERDL) to evaluate the feasibility of developing and utilizing a bench test facility as an Army procurement aid for several classes of more or less similar stationary engine applications. The most questionable part of the effort was simply to define if the military standards engines used in these applications were sufficiently similar in exhaust spectral content and the acoustic properties of their exhaust system that any one set of bench facility tests would be of significant value for extrapolating performance to all engines in the selected class. Perhaps the results of this program will be of interest to this group in defining just how a bench facility might be utilized in testing muffler "quality" and in defining some of its inherent limitations.

In this discussion, I regret that time will not permit a full discussion and description of the exact design procedures used in evolving the bench test facility (e.g., the siren), to analytically prove some of the assumptions made

(linearization procedures in extrapolating acoustic system response) or in providing experimental documentation of the validity of scaling some of the components. We could argue extensively about where to locate the microphone(s) at the muffler exhaust. Nevertheless, the results of testing on the facility may be worthy of note. I should also note that results of the bench test program were published in SAE Paper 771A, dated October 1963, and entitled (appropriately enough), "A Bench Test Facility for Engine Muffler Evaluation", by I. J. Schumacher, C. R. Sparks, and D. J. Skinner.

The first step in the program was to field test some half dozen different engines, and 47 standard design mufflers from some 6 or 8 of the major suppliers of mufflers for the MIL STD engines. This testing provided a data base on the noise from the various standard engines with exhaust sizes ranging from 1 1/2 to 3 inches, data on the performance of various muffler designs (see Table I), and data on the sensitivity of results to operating conditions.

From this point work turned to the designing of a prototype facility, and to developing techniques whereby facility data might be used to imply how a muffler might perform on an engine, or at least show a means of differentiating between obviously good and obviously bad mufflers for the application intended. It was also recognized at this point that the facility had to be fool-proof in the sense that "gimmicked" mufflers could not be designed which would show up well on the facility but which would not work well on the engines (either because of noise or performance problems).

DESCRIPTION OF BENCH TEST COMPONENTS

A photograph of the first prototype of the bench test facility is shown in Figure 1, and a schematic is shown in Figure 2. It may be seen that in addition to its noise testing feature, the facility includes provisions for making both static and dynamic backpressure measurements on the test mufflers at various flow conditions. In order to optimize upon both the mechanical and operational aspects of the facility and its component parts, comprehensive studies were made of these parameters in order to assure an optimum compromise between facility reliability and operational simplicity. Discussions of the major components and the tests used to define their operational characteristics are presented below.

Siren Noise Source - The heart of the acoustic system is the siren excitation source, shown at (1) in Figure 2. This siren produces wide band, almost "white" noise and is a constant power source by virtue of the near critical pressure drop across it. This high impedance noise generator is used instead of more conventional voice coil devices in order to simulate the impedance characteristics of an engine noise source and thereby simulate loading effects experienced when an exhaust system is attached to an engine noise source. Discussions of performance testing of this device are given in the following sections.

Manifold System - The second important component of the facility is an acoustic conduit system which serves to couple test mufflers to the siren and represents the manifolding system of an engine. For some types of testing, this component is dispensable, and useful evaluation data can be taken without

it. It serves chiefly to bring the absolute magnitude of the noise reduction more in line with numerical data obtained in the field. For facility qualification tests, this manifold is a specially designed piping component as shown in Figure 2. For other tests involving the design of special purpose mufflers, or for evaluating performance for a particular end-item application, excellent correlation with field data can be obtained by using the actual engine exhaust manifold.

Effect of Siren Pressure and Speed - A series of tests were conducted on the wide band siren to evaluate the effect of operating pressure and speed. These tests showed that the siren operates well at pressures from 2 psi to at least 15 psi. The generated noise output varies directly with the source pressure although the spectral distribution is essentially constant. The siren operating speed has a decided effect on the spectral output of the siren. It has been designed to produce wide band noise above 40 cps while operating at approximately 240 rpm. At speeds above this level, the low frequency output falls off markedly.

Microphone Position - Extensive tests were made on the piping configuration for each size of muffler to evaluate the effects of microphone position. A comparison of muffler performance characteristics measured at various microphone positions show correlation is quite good so long as the microphone is located in the acoustic far field. The exact position of the microphone is not as important if one position is selected as a standard for each muffler size, and so long as the microphone is not in the direct noise jet. Based on these tests the microphone location was set at 45 deg. from the center line of the outlet.

Effects of Gas Temperature - The effects of gas temperature on muffler performance are primarily in two areas:

1. Acoustic velocity varies directly with the square root of gas temperature, and thus the cut-off and band-pass frequencies of a given muffler shift in essentially the same proportions.
2. Gas viscosity increases with the temperature and thus dissipation elements are generally more effective at elevated temperatures. In general, this means that the percent damping of each muffler will go up as temperature increases (that is, the Q will decrease).

Test results showed that the measured octave band noise reduction characteristics of the experimental mufflers differed slightly when measured with high and low temperatures. As anticipated, the results showed that an increase in cut-off frequency was experienced at high temperatures (450 F air temperature) as well as a slight increase in the high frequency attenuation characteristics. The use of high temperature air showed no particular advantage as far as differentiating between high and low quality mufflers and as such did not warrant the added complexity to the facility.

High Flow Tests - A series of tests were conducted to evaluate the necessity for and the effect of high flow through the muffler during acoustic tests. The most pertinent results from these facility tests conducted on all three muffler sizes show that the quality mufflers can be conveniently differentiated from the low quality or empty sirens without reproducing total muffler

flow velocities experienced on the engine. Based on these tests no appreciable improvement was realized from the acoustical tests conducted under high flow conditions and as such, this requirement was excluded on the facility design.

DESCRIPTION OF FACILITY MUFFLER EVALUATION TECHNIQUES

The output spectrum of the wide band siren is shown by curve A in Figure 3. Shown by curve B on this plot is facility unmuffled output with a typical engine manifold attached to the siren. If now we superimpose on this plot curve C, which shows output noise of the siren-manifold facility with a muffler attached, the difference between curves B and C represents the noise reduction afforded by the muffler. Since the siren is designed such that each octave interval shown is rather completely filled with generated noise, specially tuned muffling devices (as contrasted to high quality mufflers) may be shown to be relatively ineffective in reducing total noise, and a numerical rating of noise attenuation can be ascribed to each test muffler on the basis of the octave band noise reduction measured.

In order to relate the octave band noise reduction figures obtained from the facility to muffler quality or loudness reduction, one must compensate for the variation of ear sensitivity with frequency, and the dependency of this frequency variation with absolute amplitude. In the program described, final evaluation of muffler quality was based upon the reduction in sone loudness afforded by a muffler when its decibel noise reduction properties are superimposed upon a typical engine noise spectrum. In order to illustrate both the concept and the procedure involved, consider a muffler with facility-measured decibel noise reduction properties as shown in Figure 4. If now we consider that the unmuffled exhaust noise spectrum shown as curve A in Figure 5, is typical for engines which might use this muffler, we can attest quality of the test muffler by computing the drop in loudness level (in sones) that the db noise reduction of the muffler would produce when superimposed upon this spectrum. If we graphically subtract the noise reduction figures from the engine noise spectrum, we get the predicted muffled noise spectrum shown by curve B. When each of these curves is converted to SAE sones, then the resulting tested quality of the muffler is the difference in these sone levels. For convenience the sone loudness scales are plotted directly on the octave ordinates of Figure 5, and it may be seen from the nonlinearities of the scales that reduction in some of the octaves is more important than in others insofar as loudness (sone) reduction is concerned. In order to supply proper weighting to the reduction values obtained for each of the octaves, some typical engine noise spectrum must be used.

In order to determine the final evaluation factor for each muffler subjected to these tests, one needs merely to sum the sone reduction afforded in each octave, or alternatively subtract the total calculated muffled sone loudness from the sone loudness of the reference engine spectrum shown. The engine spectrum used is not critical, as variations in the band levels used as reference have a second order effect on the octave band weighting factors used.

It may be seen that the process described above involves first of all, the derivation of octave band noise reduction from the bench test facility, and then the weighting of each of these noise reduction figures based upon noise

conditions typical of those to which the muffler might be subjected in field service. The entire process may be simplified considerably by graphical techniques using the noise evaluation chart shown in Figure 6. This chart again has the eight octave band ordinates. Measured muffler noise reduction values may be plotted directly upon the ordinates, and corresponding values for noise reduction may be read directly. The typical engine spectrum weighting factors are automatically included in the loudness reduction (db) figures on each ordinate. To evolve the muffler quality factor (the noise reduction value) using this chart, the process is as follows:

1. Obtain octave band NR figures for the test muffler from tests on the bench test facility.
2. Plot these decibel values on the db ordinates in Figure 6.
3. Read the corresponding noise reduction figures from the right hand scale of each ordinate.
4. Take the algebraic total of all inferred octave band noise reduction values. This is the quality factor of the muffler.

After design and fabrication of the bench test facility shown in Figure 1, an extensive series of tests were conducted on a series of mufflers with 1-1/2, 2, and 3 inch inlet sizes. It was shown that when a sophisticated simulation of the exhaust system was utilized (for example, using the actual engine manifold between the siren and muffler), facility tests ranked quality mufflers in virtually the exact same relative order as engine tests. Such numerical correlation is illustrated graphically in Figure 7, where loudness ratings from field data on the 2 inch test mufflers are shown as the center ordinate, and facility rankings using two noise calculation techniques are shown on either side. It may be seen that both field and facility tests rate the mufflers in virtually the same order, and that the facility easily differentiates the more quality mufflers (B-12 through B-21) from the empty shell (B-11).

Similar tests, but using a different manifold were shown to rate the series B-12 through B-21 in a different relative order, but they were still easily differentiated from straight pipe sections or empty shells. Since the objective of this development was a device to attest general muffler quality for use with a variety of manifolds, the standardized manifold was adopted. The entire system was thereby shown to be effective in differentiating between quality and non-quality mufflers on a rather general basis.

MUFFLER BACK PRESSURE EVALUATION

The back pressure characteristics of the military standard mufflers is perhaps the most important single evaluation criterion for most end-item applications. Since the military standard muffler design is not tailored to a specific application, a compromise in the noise reduction characteristics was favored to meet the maximum back pressure limits. An extensive series of tests were conducted on the mufflers under a variety of both steady flow pulsating conditions. Data were recorded using both a water manometer and a flush-mounted pressure transducer, and were compared with field data obtained with a flush-mounted

transducer installed in the engine exhaust system. The results showed that under steady flow facility conditions (with siren off), excellent correlation was obtained between field results and facility results using either a flush-mounted transducer or a water manometer for facility measurements. The data also indicated that full engine flow rates need not be simulated to perform these tests and that the amount of flow required is dependent only upon the resolution of the back pressure measuring system. Comparatively high flow rates (240 scfm) are required for the large size mufflers in order to obtain necessary reading accuracy when a water leg manometer is used. Alternately, lower flow rates could be used with a more sensitive pressure transducer, but this system would suffer from the complexity of calibration and data interpretation. The correlation of steady flow back pressure measurements recorded on the facility to engine back pressure data obtained during the field tests is presented in Figure 8.

ANALOG SIMULATION TECHNIQUES

Another means for evaluating engine mufflers, at least in the difficult low frequency portion of the spectrum, lies in electronic analog simulation of the proposed muffler-manifolding configuration. The most sophisticated and well-documented basis for this contention in the SGA Compressor Installation Analog, developed and operated by Southwest Research Institute for the Southern Gas Association's Pipeline and Compressor Research Council (See Figure 10). While the primary purpose of this analog is to simulate pulsations in the piping systems of reciprocating compressors (to date some 3000 such studies have been conducted), it is also useful and has been used as a tool for design and evaluation of engine muffler and exhaust systems. Using this analog, the total flow characteristics (steady state and transient) of a piping system such as a muffler and exhaust system can be modeled using electronic delay line elements which are simply coupled together to simulate the acoustic impedance network of the exhaust system regardless of complexity. Lumping lengths can be chosen arbitrarily short to accommodate whatever upper frequency limit is desired, but pipe diameter does impose some upper frequency limitations. The simulation assumes one-dimensional compressible flow, and is therefore limited in applicability to frequencies whose wave lengths are large compared to pipe diameter. For a six inch exhaust system, therefore, the upper frequency limit is on the order of 500 Hz.

It is readily noted, however, that it is precisely in the low frequency ranges where muffler performance is difficult to predict analytically, and where piping interaction effects are most important on muffler performance. High frequency attenuation is relatively easy to achieve in a muffler, and once low frequencies are controlled, the high frequencies normally take care of themselves. Standard acoustic theory (viz. lined duct absorption effects) serves as an adequate tool to design additional high frequency attenuation if it should be desirable.

The process of simulating an exhaust system on the analog is a relatively straight-forward impedance simulation using a series of analogies where voltage represents pressure (AC and DC), and current represents mass flow.

If we start with the equations of motion, continuity and state for one-dimensional, isothermal, compressible flow, and compare these to the electrical

delay line equations, we find that a very convenient set of analogies occur wherein

Electrical Inductance \propto Acoustic Inertance

Electrical Inductance \propto Acoustic Compliance

Electrical Resistance \propto Acoustic Damping.

Specifically, the electrical parameters of inductance (L), capacitance (C), and resistance (R), per unit length of pipe are:

$$L = K_1 \frac{1}{A}$$

$$C = K_2 \frac{A}{c^2}$$

and

$$R = K_3 M$$

where

ρ = flowing density

A = pipe flow area

c = acoustic velocity

M = mass flow rate

K = constant

Using acoustic theory the same set of equations are derived, except that the resistive term is assumed linear of the approximate form

$$R = 1.42 \left(\frac{\mu}{\rho} \right)^{1/2} \frac{\rho M}{\pi r^3}$$

as contrasted to the fluid dynamic viscous resistance which is of the form

$$R = K_3 \frac{fc^2}{2\rho A^2} M$$

Considerable experimental work has been conducted to evaluate the relative magnitude of the two resistive mechanisms, and results show that for all pipe sizes of practical concern (i.e., larger than capillary tubing) and for all flow rates on the order of several fps or greater, that the fluid dynamic term predominates. Thus for most systems, the non-flow acoustic resistance mechanisms (e.g., molecular relaxation) can be ignored with negligible effect.

It may be seen by inspection that of the three basic impedance terms defined

(R, L and C) both L and C are quite linear with flow. Since these two parameters determine electrical (and acoustic) propagation velocities, an excellent simulation is achieved of muffler attenuation rates, cut-off frequencies, internal resonances or pass-bands, and interaction frequencies caused by attached piping. The only parameter undefined by R and C is the amplitude of the various resonance peaks which are controlled by resistive damping. Since the R is non-linear with flow, simulation can be achieved either by inserting nonlinear resistance circuits into the delay lines, or by linearizing the R for the average mass flow rate M. Experience with many simulations have proven either approach is adequate.

The question which usually comes up at this point is "What about perforations". Again, both analytical and experimental data shows that for non-flow acoustics, perforation size must be quite small before the elements become resistive rather than reactive. In Figure 11 perforation Q is plotted as a function of hole size for various frequencies. Note that hole diameters must be less than a quarter inch before the R predominates (i.e., before $Q < 1$).

In the case of flow through perforations, analog data has been compared extensively with laboratory and field data, and again the results show that the predominating effect in achieving pulsation damping is the same mechanism which produces pressure drop. Specifically, the dynamic (acoustic or pulsation resistance) is numerically equal to twice the steady state resistance, i.e.,

$$R_{AC} = 2 \times R_{DC} = 2 \frac{\Delta P}{M} \quad \text{steady flow}$$

Using this approach, excellent correlation has been obtained between the analog and field data for perforated element acoustic filters. An example is given in Figure 12 which shows the pulsation spectrum from 0 - 100 Hz for a reciprocating compressor. More specifically, the data shows the envelope of pulsation amplitudes as compressor speed varies over a range of $\pm 10\%$.

Again, the problem of using such a device for evaluating mufflers lies in the question of what constitutes quality in a muffler. Although the analog will accurately map filter attenuation as a function of frequency, including all pass-bands and interaction effects of attached piping, the noise reduction data obtained is for that particular exhaust system. If significant changes are made in the manifold, tail pipe, etc., then data can be modified substantially. Figure 13 is one example of analog data taken for a proposed muffler design for a large stationary natural gas engine. Note that noise levels and spectra can be observed anywhere in the system, but that as the piping configuration is changed, output noise from the muffler will likewise change.

BLACK COPY

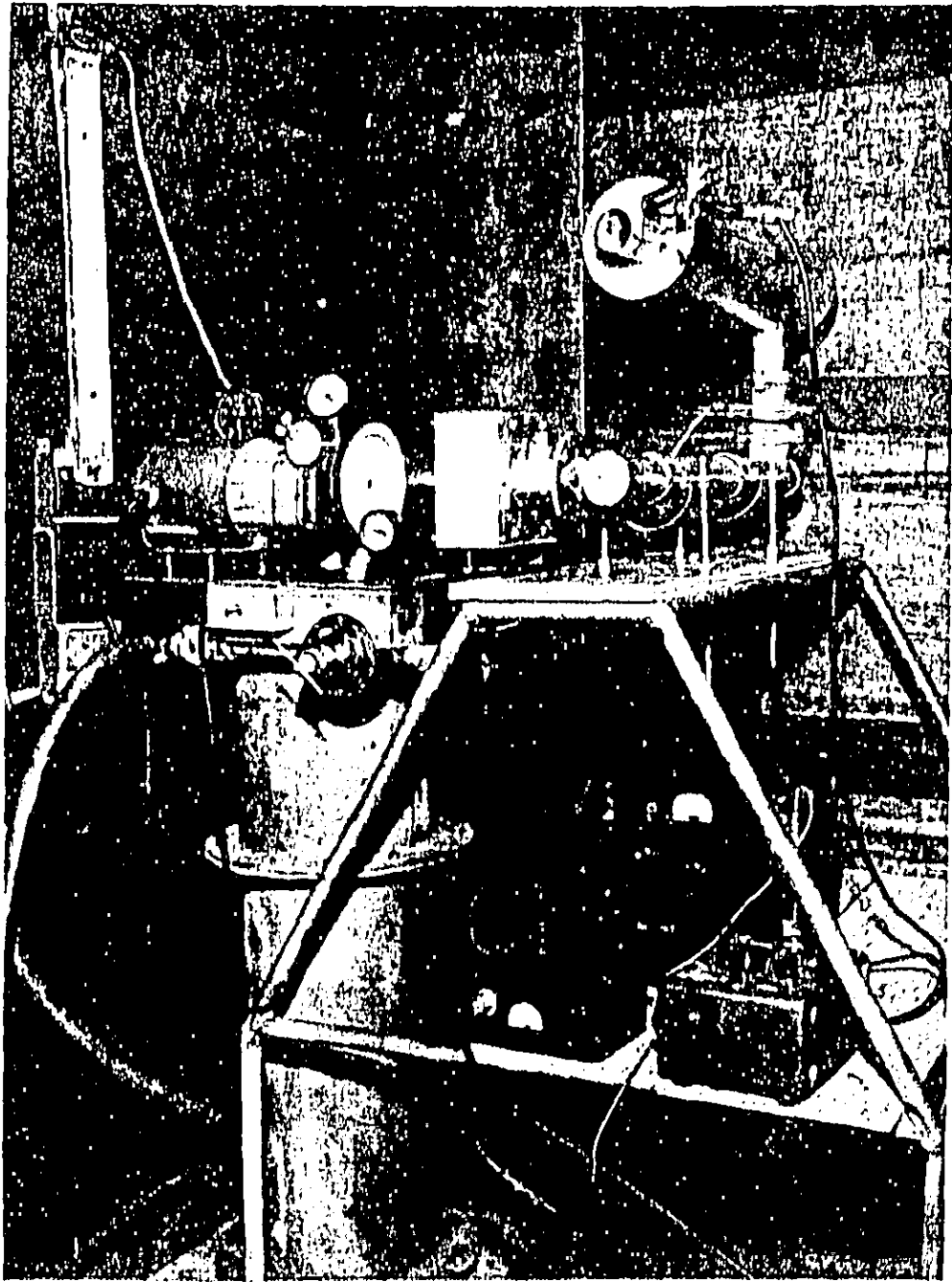

FIG. 1. FIRST PROTOTYPE OF MUFFLER BENCH TEST FACILITY

Table 1 - Field Results From Engine Tests on Experimental Muffler.

Engine Exhaust Size - 3 in.

Muffler No.	Engine Noise	Open Exhaust	A-1	A-2	A-3	A-4	A-5	A-6	A-7	A-8	A-9
	83	105	104.5	101	103.5	100.5	102	101	100.5	102	102.5
	28.8	102.2	93.8	88.4	89.3	71.1	83.3	73.8	78.3	77.6	83.8

Engine Exhaust Size - 2 in.

Muffler No.	Engine Noise	Open Exhaust	B-11	B-12	B-13	B-14	B-15	B-16	B-17	B-18	B-19	B-20	B-21
	76	95.5	92	94.5	94	94	93	86.5	89.5	94.5	96	93	93
	19.8	53.2	38.3	43.9	42.7	46.7	39.8	28.2	40.2	46.1	48.7	45.1	38.9

Engine Exhaust Size - 1-1/2 in.

Muffler No.	Engine Noise	Open Exhaust	C-23	C-24	C-25	C-26	C-27	C-28	C-29	C-30	C-31	C-32	C-33	C-34
	74	94	88	89	85	88	90	91.5	91	88	86	87	88.3	88
	17.4	37.6	28.1	31.2	26.7	29.7	29.4	33.1	31.6	39.0	24.8	28.5	30.1	24.8

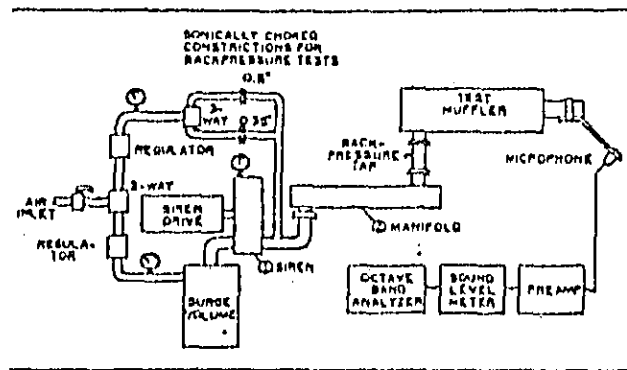

FIGURE 2
Schematic of Bench Test Facility

BEST AVAILABLE COPY

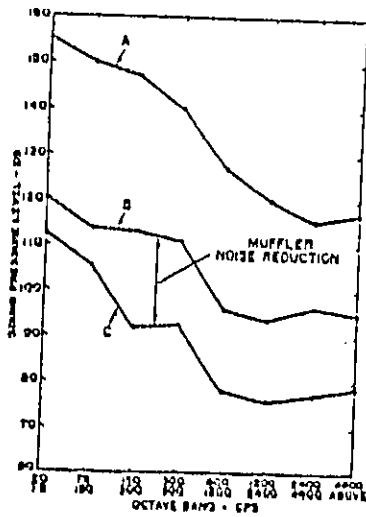

FIGURE 3
Octave Band Analysis of
Facility Noise Characteristics

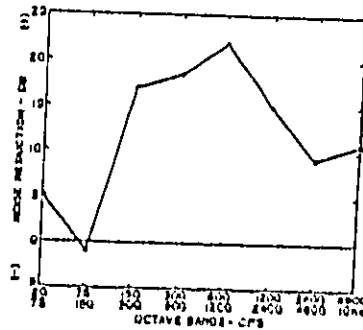

FIGURE 4
Octave Band Analysis of Noise
Reduction Figures from Typical
Experimental Muffler

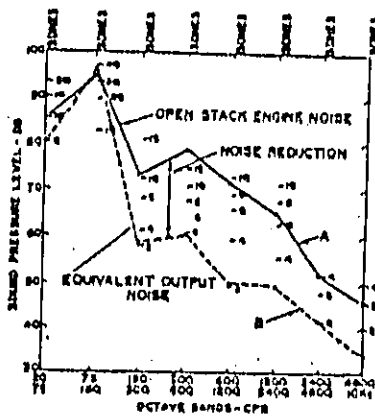

FIGURE 5
Graphic Example of the Effect
of Muffling Action upon Exhaust
Noise Loudness

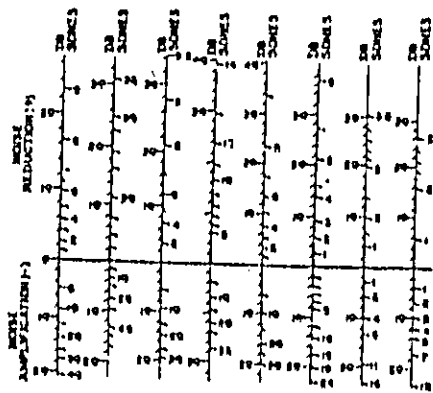

FIGURE 6
Evolved Sone Evaluation Chart for
Direct Evaluation of Muffler Quality
from Test Bench Data

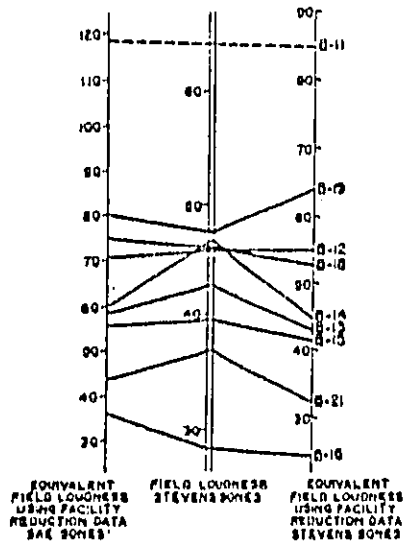

FIGURE 7
Comparison of Field and Facility Evaluations of Muffler Performance

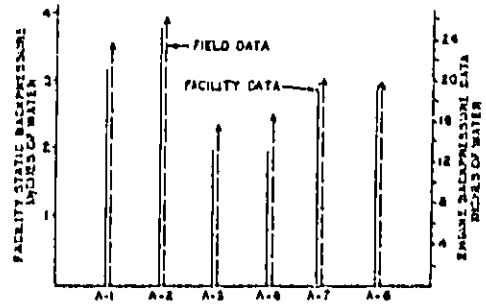

FIGURE 8
Comparison of Field and Facility Muffler Backpressure Ratings

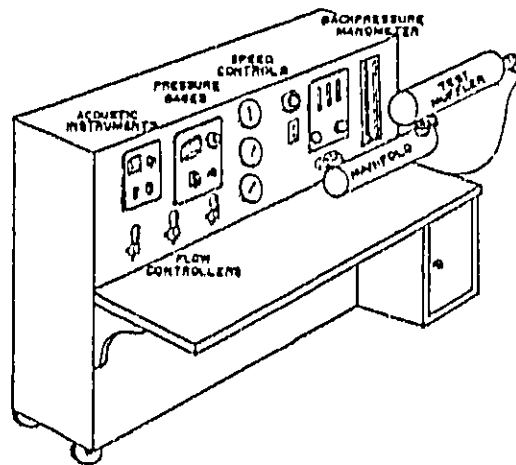

FIGURE 9
Final Prototype Muffler Bench Test Facility

BLACK COPY

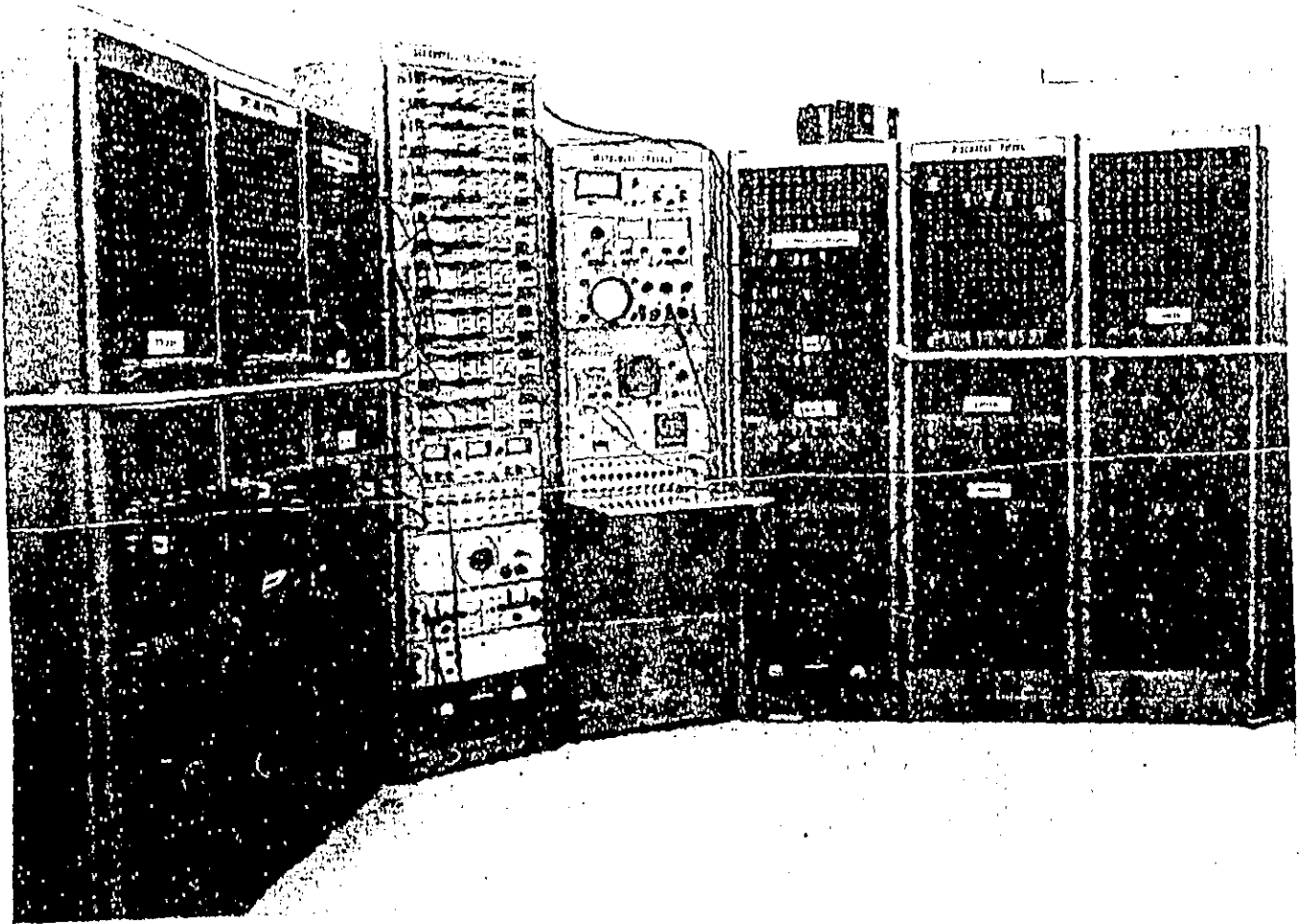
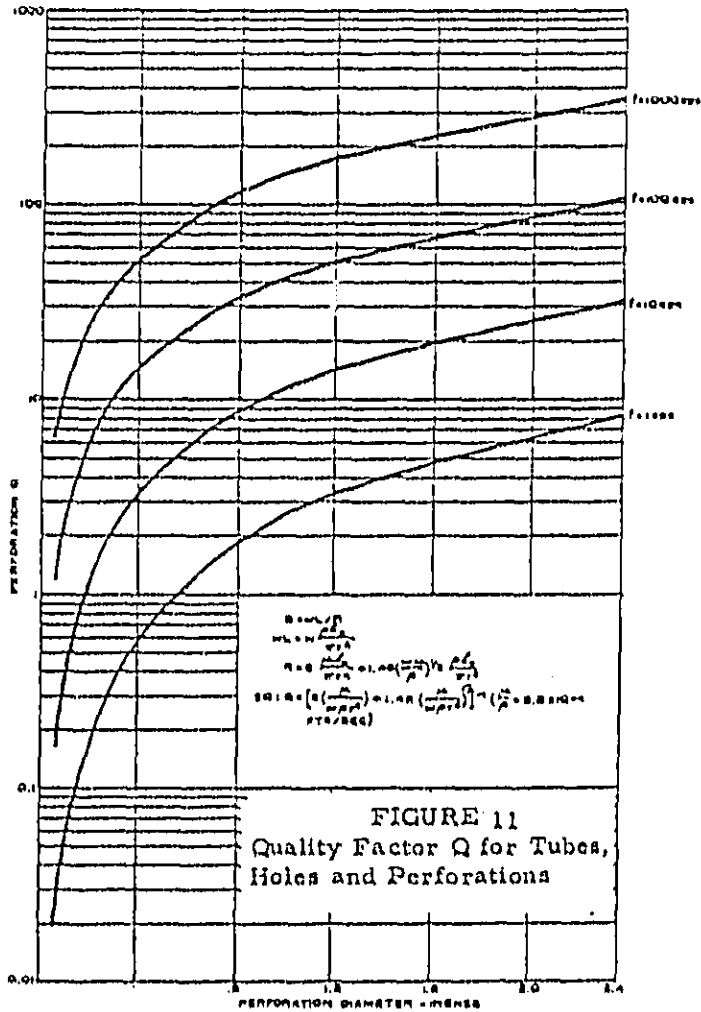

FIGURE 10
Electroacoustic Analog for Simulation of the
Acoustic Response of Piping Systems

157

BEST AVAILABLE COPY



BLACK COPY

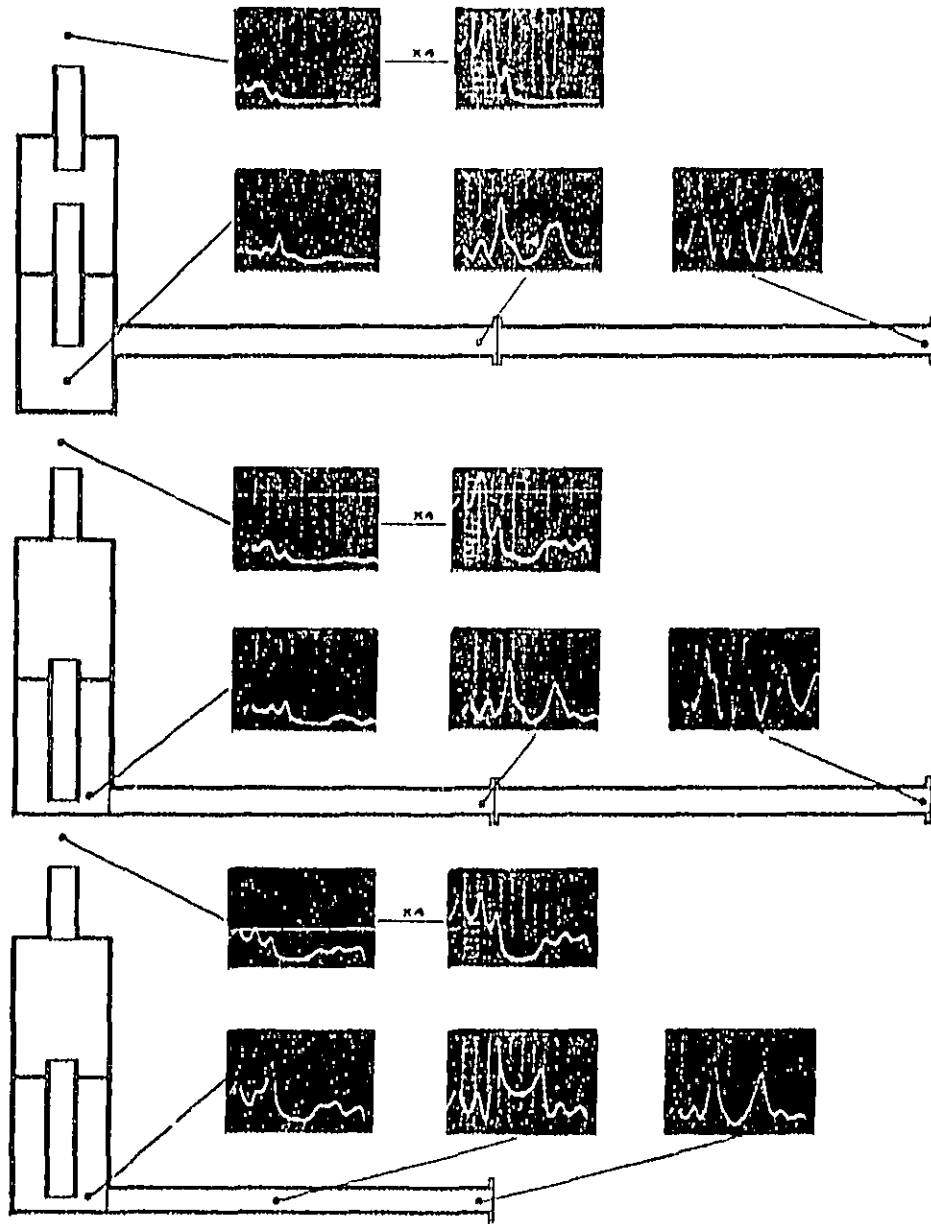

Huffler and Exhaust System Performance Characteristics
as Recorded on the Electroacoustic Analog
FIGURE 13

Comments on Evaluation Techniques
of Exhaust System Noise Control
Characteristics

D. W. Rowley
Donaldson Company, Inc.

Before discussing possible exhaust system bench evaluation techniques as charged by Dr. Roper in his introductory comments yesterday, let me first state my vantage point. In the area of surface transportation noise control, Donaldson is a manufacturer of both induction and exhaust system products for medium and heavy duty trucks ... primarily intake air cleaner-silencers and exhaust mufflers. Donaldson also provides products for recreational vehicles, light aircraft, and for railroad locomotives.

This morning I would like to discuss with you those steps we find necessary to insure ourselves and our customers that the muffler and exhaust system for a given truck and engine indeed do the job for which they were intended. Primarily I'll be speaking toward the heavy duty, diesel truck.

I'm going to review "how we do the job of developing hardware and then its evaluation." To this point in the symposium, most of the speakers have been heavily concerned with non-engine, bench test, acoustic theory. Well now we're going to spend a few minutes concentrating on the real world of engines, trucks, and their exhaust systems.

First, when a request is received for a given job, it's worthwhile to determine if a suitable product is already in existence. For this a catalog or recommendation sheet may be referred to, Fig. 1. The data shown is from actual engine testing. Note that the performance of a particular product depends on the engine and the exhaust system with which it is used.

If a muffler with the desired configuration and performance cannot be found in the recommendation sheets, a computerized selection program may be used. The program consists of two major listings. The first describes the flow

and acoustic characteristics of approximately 135 engines, and the second describes the flow loss and noise control properties of our standard line of truck mufflers -- about 80 models are included.

By inputting the engine and truck type and the exhaust system to be used, the computer will "match" the two lists, perform the required calculations, and "select" those mufflers most applicable. Performance is predicted in a form similar to the recommendation sheet. The accuracy of the prediction is within 3 dBA of actual engine-dynamometer tests. It is also possible to select a given muffler and predict that muffler's performance on all engines for which it will "fit" backpressurewise.

These methods have been reviewed because either could conceivably be used in a labeling scheme, -but please remember their accuracy and again note, they depend on engine-dynamometer testing as well as flow bench pressure drop data for a basis.

If a suitable product is not available, a development program must be implemented. The design and analytical stage involves utilization of math model analysis techniques to provide an estimation of the muffler's transmission and insertion loss. Next samples are obtained and evaluated. First, the samples are tested on a flow bench to determine if flow pressure drop is satisfactory. If OK, "non-engine" acoustic bench testing is then used to evaluate the acoustic performance of the muffler and exhaust system. For this loud speakers, sirens, shock tubes, air reinforced electrodynamic speakers -- all have been employed. Many of these methods are worthwhile development tools. They can, if properly utilized, rank mufflers by performance quite effectively ... some methods better than others. The closer to the actual exhaust system conditions, the more accurate the ranking.

To do a good job of evaluation on a "non-engine" bench test, one must somehow simulate actual engine exhaust system conditions of:

- Gas flow, temperature and temperature gradient down the exhaust system.
- The total exhaust system must be used: exhaust pipe and silencing devices, connecting pipes and tailpipe, and probably most difficult, something to simulate engine impedance.
- Generation of noise with a similar spectral content to the engine of concern, and
- Of high enough amplitude (140 - 170 dBA) such that non-linear acoustic conditions exist. Non-linearity cannot be ignored since it can significantly affect acoustic velocity ... especially in a naturally aspirated engine.

A large amount of complicated material to attempt to handle! Perhaps someday it will be possible, but at the moment we can't do it with anywhere near the accuracy required.

Frankly, it's easier to obtain an engine, provide adequate control measures, and perform the tests on the actual engine and exhaust system. This in itself is quite demanding. The engine must be right. It must have proper fuel and intake air flow, with rated power output and normal exhaust gas temperatures. A top-notch technician to perform the test is a must, along with equally top-notch instrumentation.

We're almost ready to talk about engine test data, but first let's define exhaust noise. Fig. 2 is an illustration of exhaust noise ... being made up of tailpipe discharge noise, muffler shell noise, exhaust pipe surface radiated noise, and also the noise transmitted through any leaks in the exhaust system. At the bottom of the figure is a typical example of the levels of these subnoises required for 1978 trucks.

Let me explain. Although the manufacturers are faced with meeting an 83 dBA overall truck level, their prototype truck design goal, because of regulated test methods and manufacturing variations, is from 80 to 81 dBA in order to be safely under the 83. And since it is oftentimes desirable to reduce exhaust noise so that it is essentially a non-contributor, the goal for exhaust noise becomes 10 dBA less ... or the low 70's. This in turn then requires the very low values shown for the sub-sources.

Now as we look ahead to the 80 dBA 1982 truck, the sub-sources will become that much more difficult to control to the very low levels required, Fig. 2.

The sub-sources can in turn be broken down ... sub-sub-sources, as presented in Fig. 3. The tailpipe discharge noise is made up of the exhaust noise created by the engine that escapes through the muffler and is radiated out the tailpipe. It also includes muffler generated noise caused by gas flow through the muffler, and "jet" noise created by high velocity exhaust gases escaping into the atmosphere.

Exhaust pipe surface noise is caused by the high internal dynamic pressure within the exhaust piping.

Muffler shell noise isn't as straight forward as it might appear. It's mainly caused by the internal pressures within the muffler, but it also radiates engine and chassis vibrations that are transmitted to it via the exhaust system. The muffler surface can also radiate exhaust pipe vibrations as set up by the internal dynamic pressures.

Now with that background, let's get into engine testing. Fig. 4 presents a 50 ft. exhaust noise from a fully loaded engine. The information was gathered by isolating engine mechanical noise by using a full enclosure

and a heavy isolation wall. The wall is acoustically treated on the outside, creating a free field above 150 Hz. The data in the figure is within 1 dBA of a completely free field over a reflecting plane. This particular engine is rated at 2100 rpm. The engine is warmed up and set to full load at 2100 rpm. The exhaust system is allowed to stabilize at operating temperatures. Under these conditions much of the analysis work is done ... spectrum, octave band, wave shape, and the muffler internal elements are evaluated. In this particular case, a 72 dBA would be reported at full load and rated rpm. Then the "lug-down" mode is run. For this, load is taken off the engine until it speeds up against the governor. In this case the governor is controlling the engine rpm to 2400. Then load is slowly added, such that the engine is "logged" down through its operating range to approximately 2/3 rated rpm. The 2/3 is important because of the agreement with the SAE 366b drive-by test. Only one serious peak was found ... 75 dBA at 1500 rpm which would be reported accordingly.

One other test mode is considered, Fig. 5. This is the sudden acceleration, run up, goase, idle-max-idle (IMI), or whatever. Notice the differences from the lug mode. Values of 73 dBA at 1700 rpm and 73.5 at 2250. Both would be reported.

There is yet another test mode required ... one that will show the effect of temperature on system performance. Surface radiated noise becomes of more importance as muffler attenuation increases. Surface noise is a function of the temperature of the exhaust system parts. If the surface is cold, it is more "live" (high Q) with a resulting greater surface radiated noise. This is demonstrated in Fig. 6, Muffler, and again in Fig. 7, Exhaust Pipe. These are copies of the actual work sheets. Note the difference between stabilized conditions in the exhaust system and cool conditions ... approximately a 5 dBA difference for the muffler, and about 7 for the pipe ... quite considerable.

In essence, five or six pieces of peak data are recorded. Obviously we're looking for the worst condition. That's the condition very probably that the truck manufacturer would run into, or possibly could run into, as he evaluates his truck.

Pipe surface noise was further investigated as a function of time, Fig. 8. A 55 dBA can be seen for pipe surface radiated noise at idle, 500-600 rpm. Then the throttle was punched wide open creating an exhaust noise peak of 78 dBA. As the momentum of the engine is overcome, the level drops down to 65. At that point, load was put on the engine. Immediately, the pipe surface noise went up to 75 dBA and then as the system absorbed heat and the temperature of the material increased to a stabilized condition, the pipe noise likewise decreased.

The purpose of presenting the last series of figures was to provide some indication of the difficulty of rating system performance even while testing with the actual engine and system.

Now let's look at other problems of evaluating systems ... in this case distributed systems, Fig. 9, which are becoming more popular in the industry. Distributed systems contain more than one silencing device. These additional components are acoustically interrelated with the primary muffler and one another. That is, the performance of the primary muffler is affected by other devices in the system, and vice versa. Fig. 10 is further evidence of this. Consequently, it's very difficult to say this particular muffler or silencing device has such and such acoustic characteristics without referring to the performance in an actual system. The "whole" system must be evaluated.

With the complete data from an engine-dynamometer test, we have a pretty good handle on the performance of the exhaust system on a given engine;

but, we're still not completely convinced. So the next step obviously is going to a truck, which is the real "proof of the pudding" (includes truck noise source identification). The type of data gathered from a truck test is shown in Figs. 11 and 12.

By utilizing the type of testing just reviewed, we try to meet our commitment to the truck manufacturers and the trucking industry ... striving to make certain that the exhaust system controls the noise as intended and without compromising engine performance. It is also required via testing to provide proof of conformance to manufacturers' specifications.

In conclusion, any evaluation method selected must meet certain degrees of accuracy. The lower the overall truck noise levels established, the more sophisticated the mufflers and other silencing components will become; and it follows, the more critical the accuracy of evaluation also becomes. As of this point in time, this can best be done with an engine-dynamometer type of test.

Presented at: EPA Surface Transportation Noise Symposium
Chicago, Illinois
October 12, 1977

Reference: SAE Paper No. 770893, "Exhaust System Considerations for 1982 Heavy Duty Trucks."

DWR/dp

Muffler Application Data
for Truck Exhaust Systems

Detroit Diesel BV-71 N

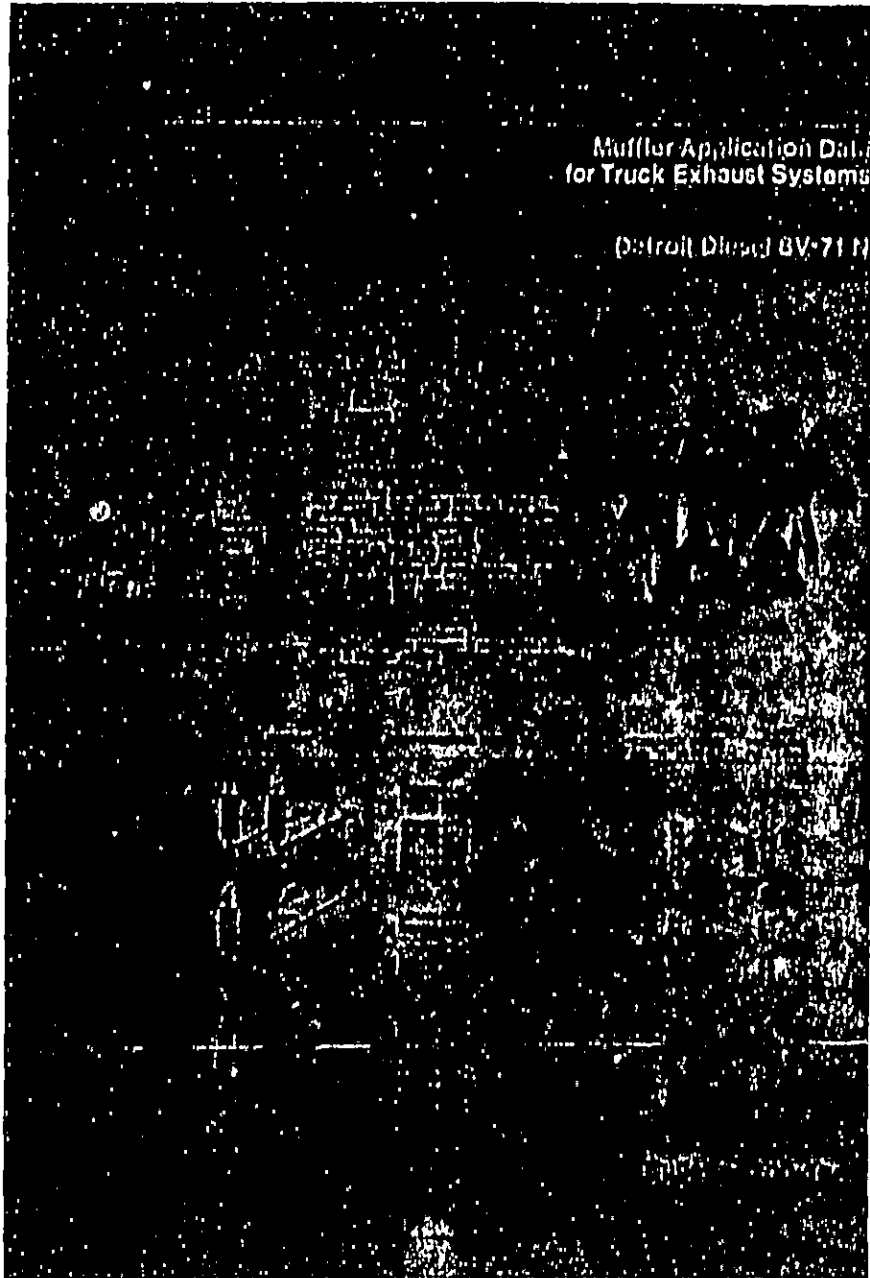

Figure 1
168

BLACK COPY

BEST AVAILABLE COPY

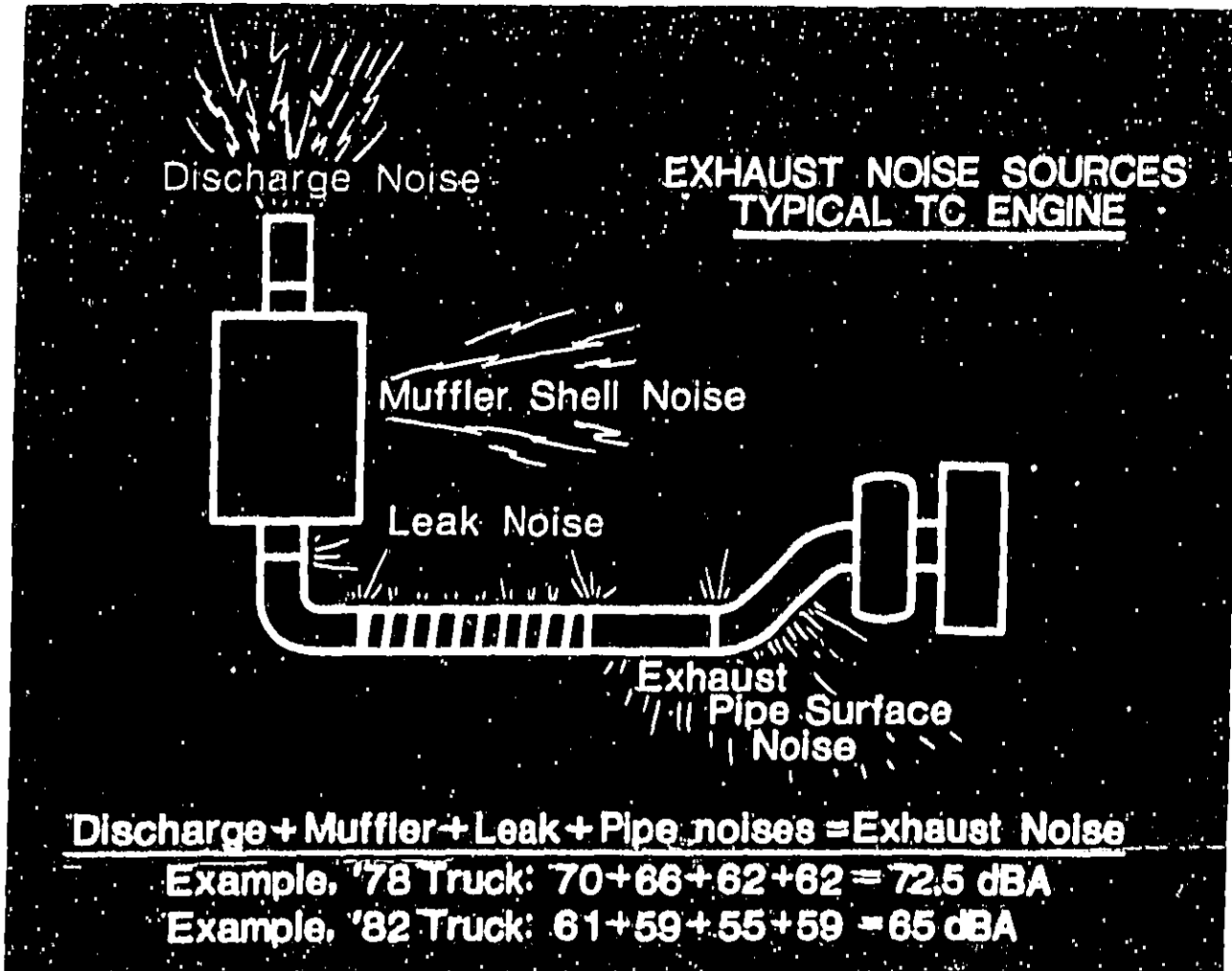
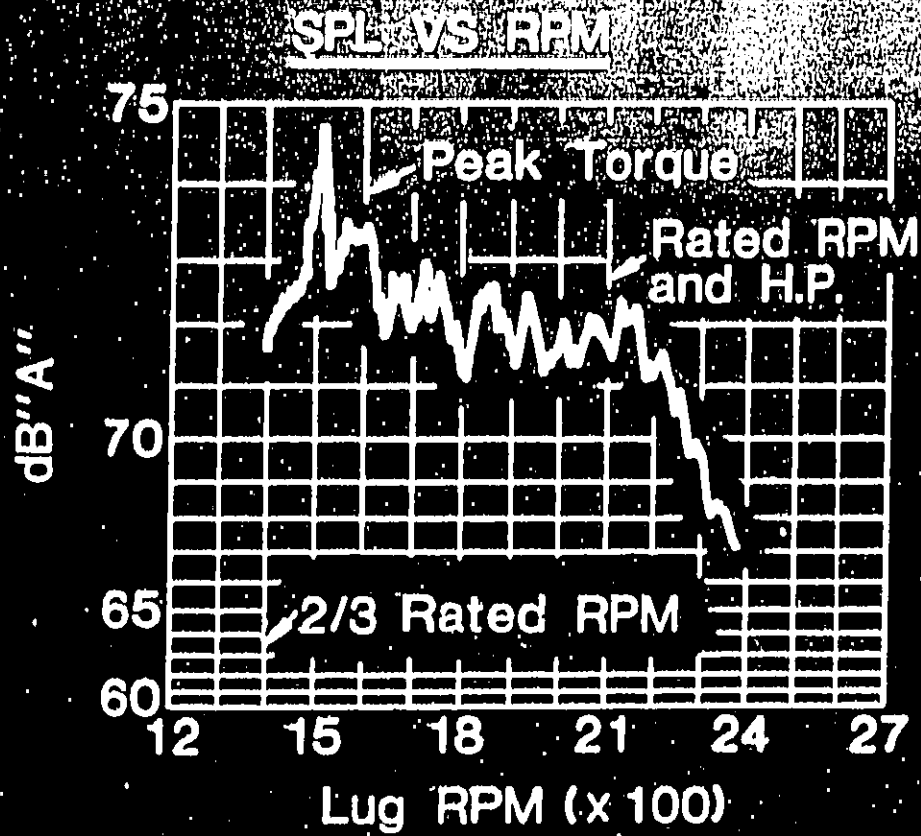

Figure 3

EXHAUST SYSTEM NOISE TARGETS

	1982 <u>Target dBA</u>
Tail Pipe Discharge Noise _____	61
Exhaust noise thru muffler _____	59
Muffler generated _____	57
Tail pipe jet noise _____	<51
Exhaust Pipe Surface Noise _____	59
Muffler Shell Noise _____	59
Internal muffler pressures (SPL _{im}) _____	56
Engine / Chasis vibrations (SPL _{ev} / SPL _{cv}) _____	52
Exhaust pipe vibrations (SPL _{ip}) _____	54
System Leak Noise _____	<55
Total dBA _____	<u>65</u>

Figure 3



171

Figure 4

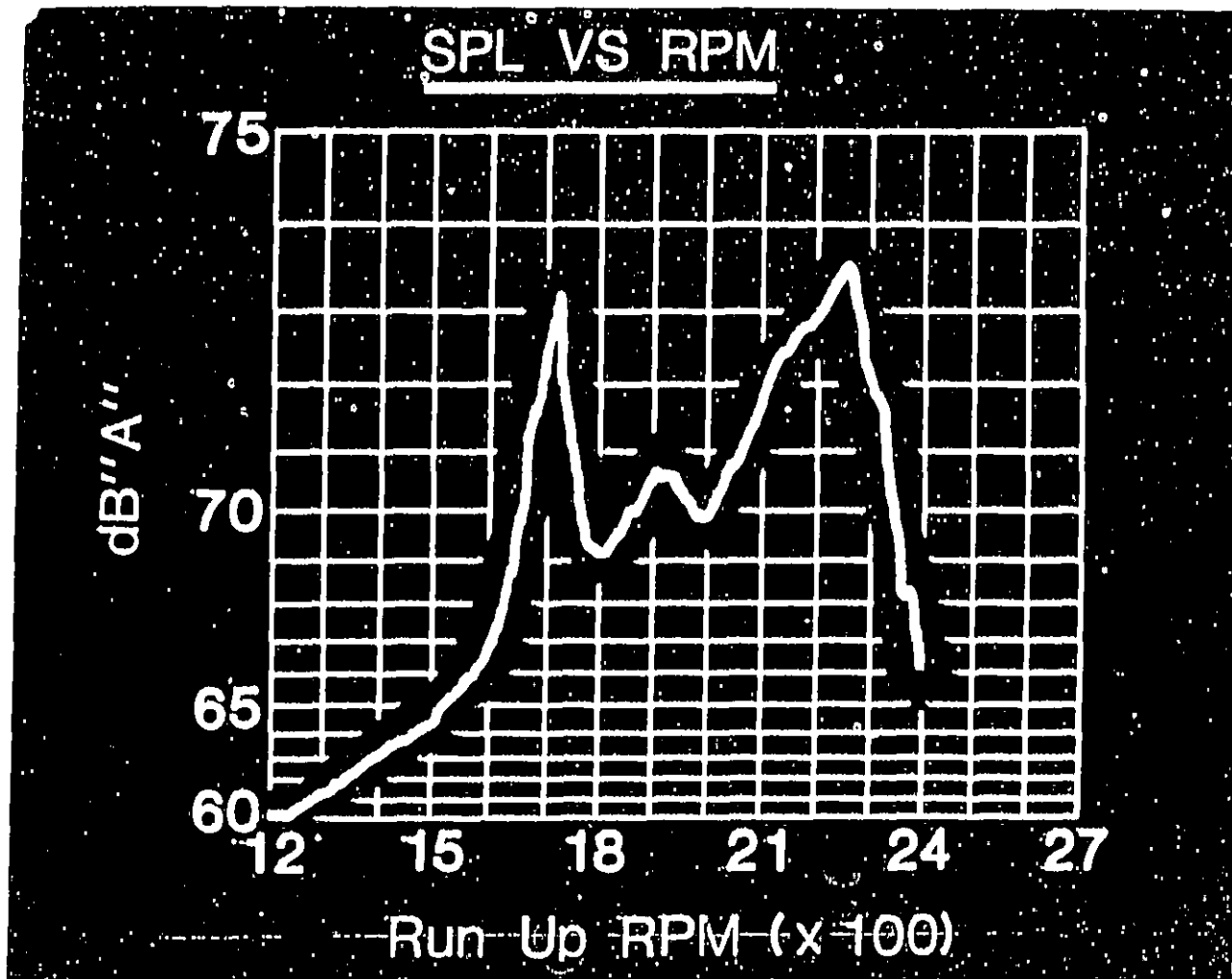

Figure 5

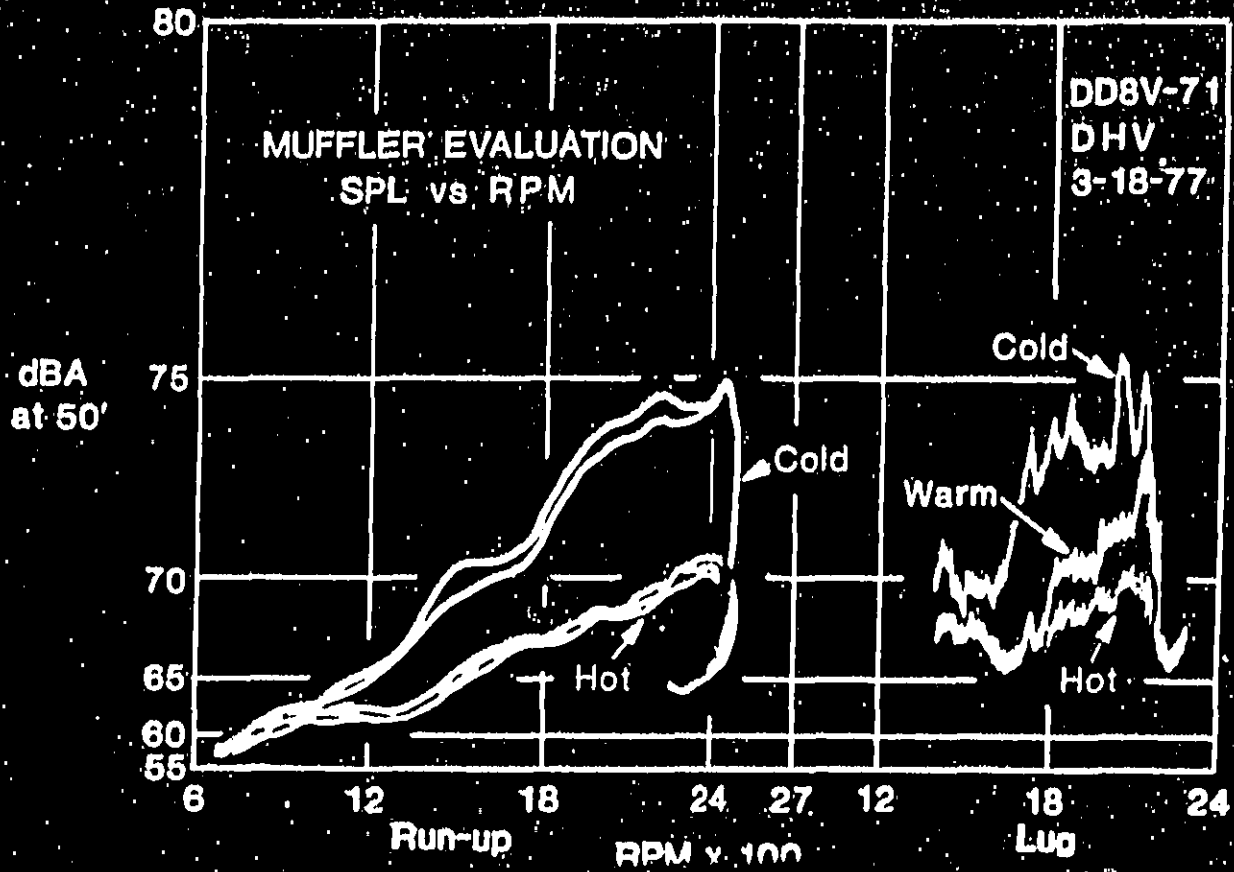

Figure 6

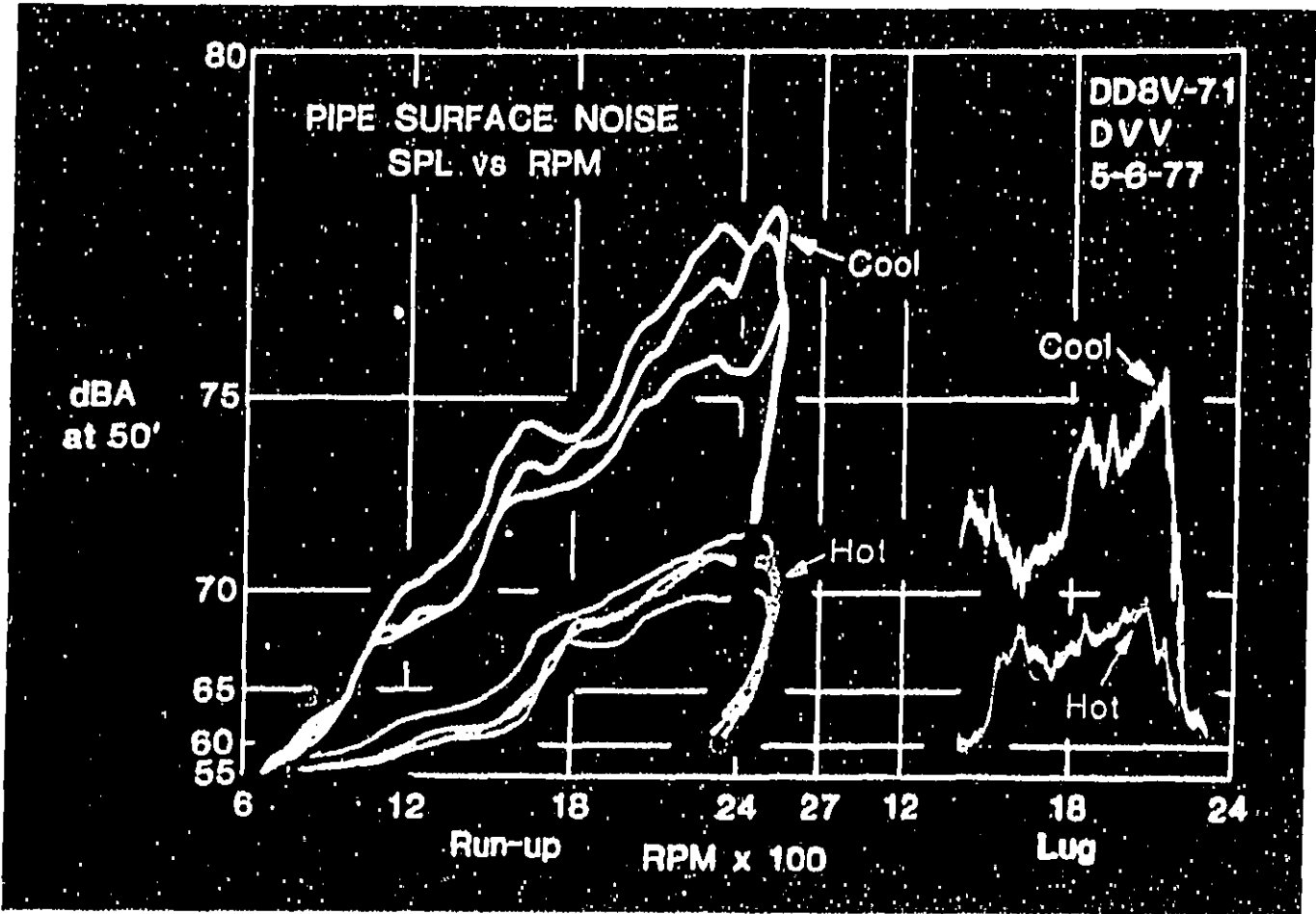

Figure 7

174

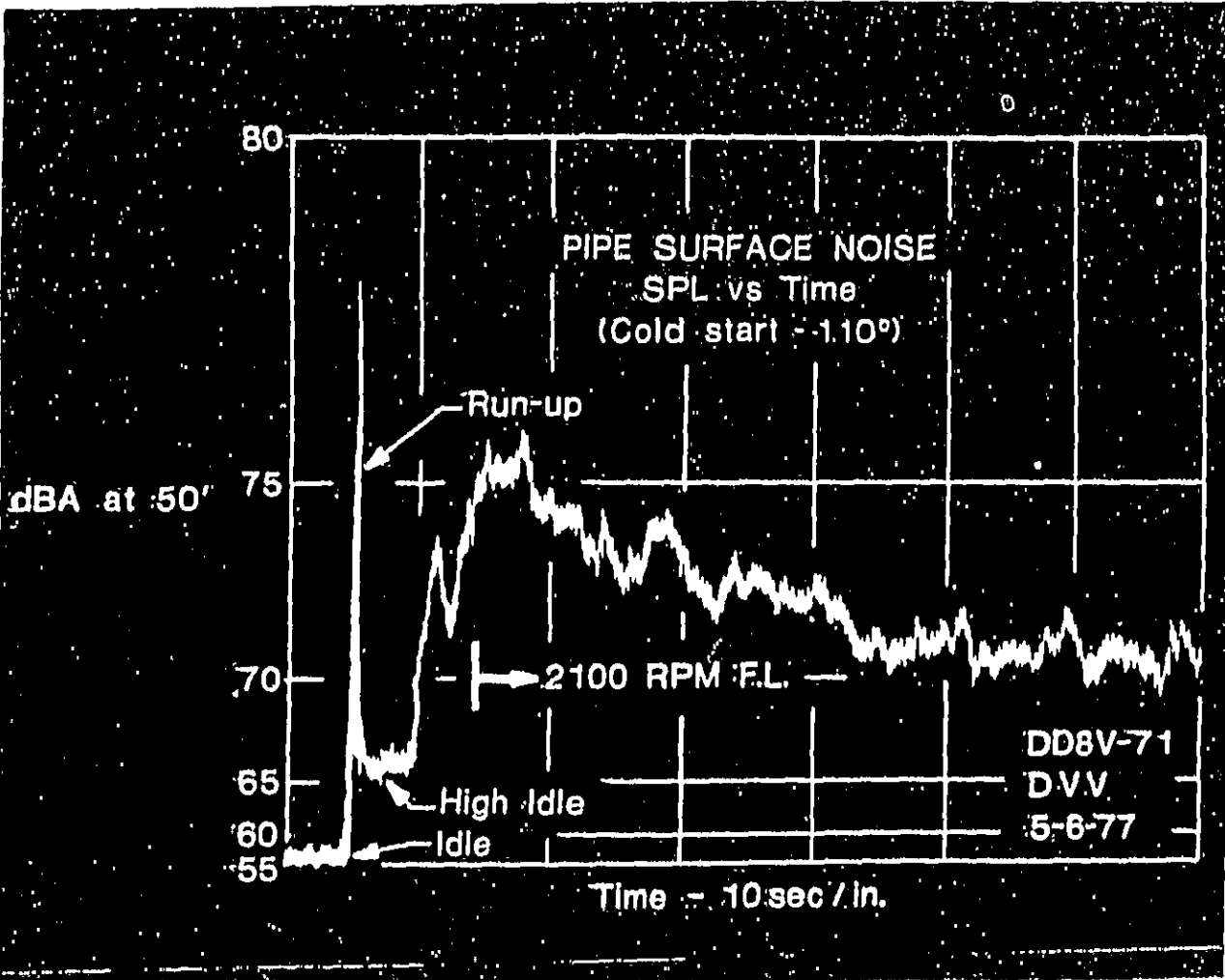

Figure 8

175

BEST AVAILABLE COPY

DISTRIBUTED EXHAUST SYSTEMS N/A DIESELS

(Approx 50' dbA Levels)

	<u>Single</u>	<u>Dual</u>
Muffler	76	73
+ Wye Can	72	-
+ Resonator	70	69
+ Stack Silencer	68	67

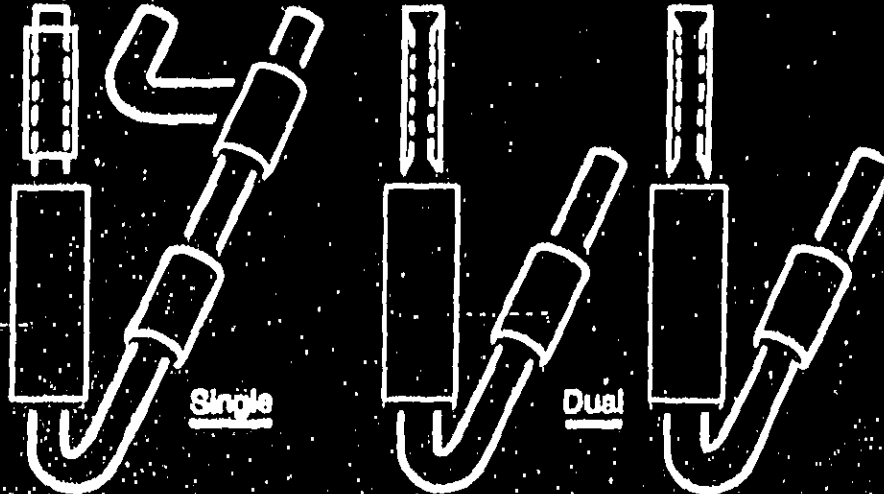

Muffler
 Inside Stack Silencer
 Wye Can
 Resonator
 Outside Stack Silencer

BLACK COPY

RESONATOR LOCATION

Muffler.....9" X 4'
Resonator.....7" X 1.5'
Piping.....4"

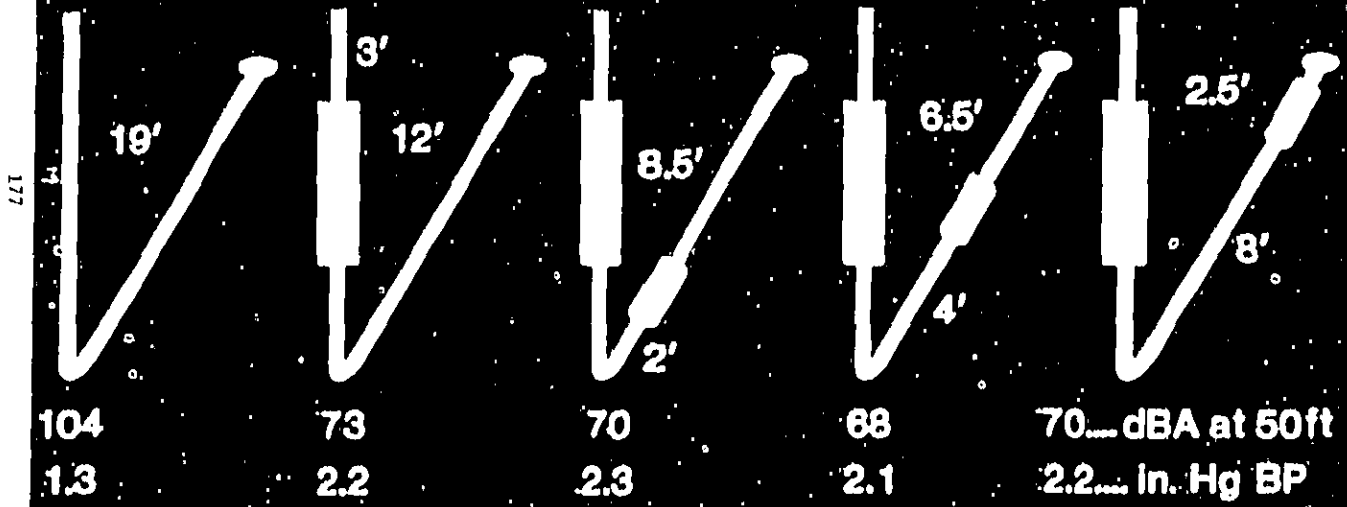

Figure 10

178

PASS BY
dB''A'' vs Time - per SAE J366b

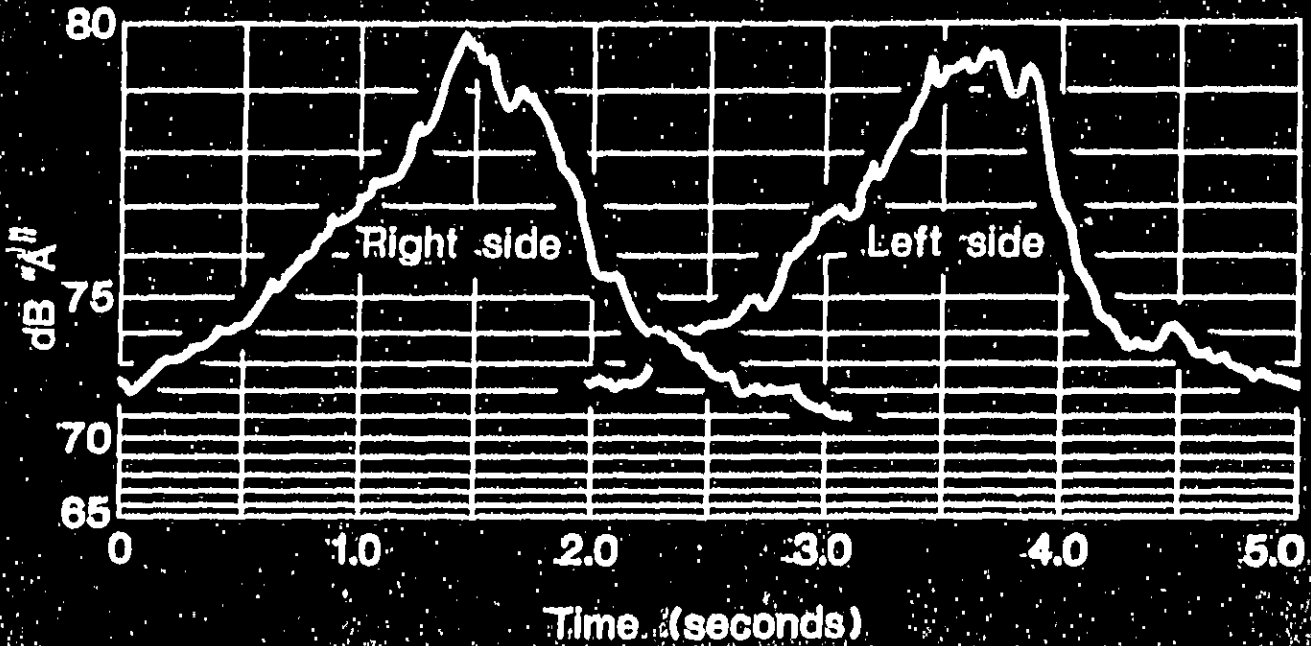
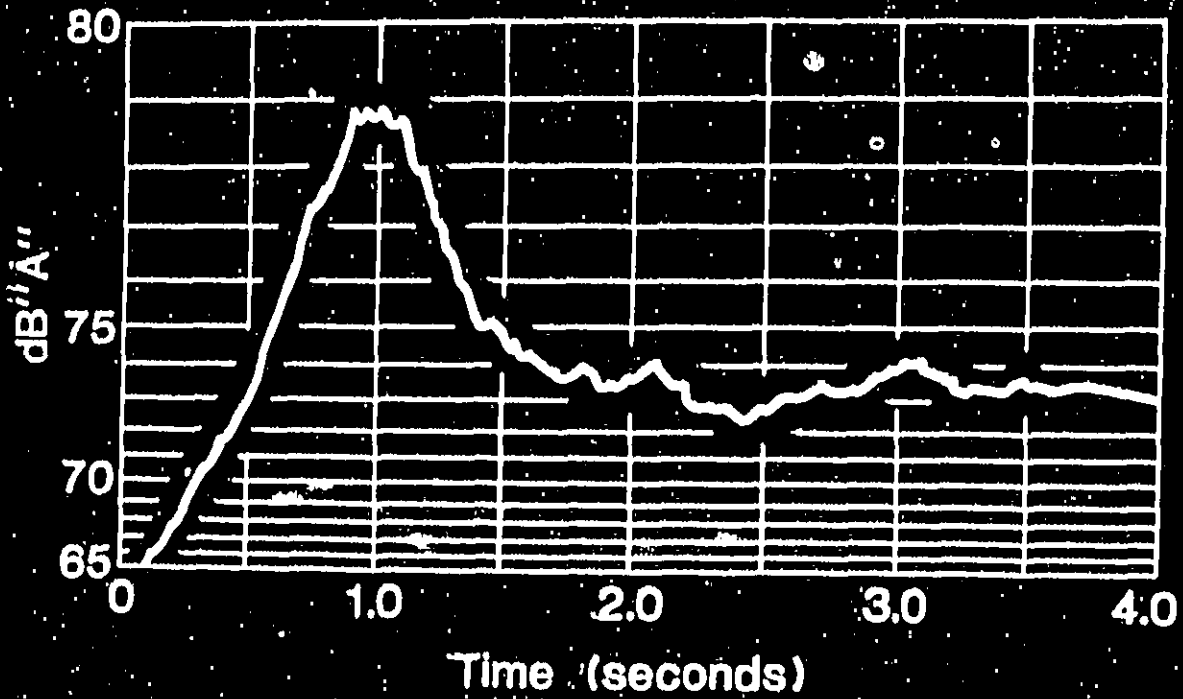

Figure 11

dB''A'' vs Time - per EPA STATIONARY TEST
No Load I-M-I



179

Figure 12

A BENCH TEST FOR
RAPID EVALUATION OF MUFFLER PERFORMANCE

by

A. F. Seybert
Department of Mechanical Engineering
University of Kentucky
Lexington, Kentucky 40506

INTRODUCTION

The United States Environmental Protection Agency has published general provisions for noise labeling standards [1]. Among other things, these provisions indicate the need for test methodologies for the evaluation of the acoustic characteristics of products to be labeled. This paper discusses some of the problems associated with the prediction of exhaust system performance and presents a novel technique for the measurement of muffler characteristics. It is shown that exhaust system performance can be predicted using measured muffler characteristics in conjunction with other known information such as engine impedance and pipe lengths.

BACKGROUND: FACTORS INFLUENCING EXHAUST SYSTEM PERFORMANCE

Figure 1 shows some of the factors influencing overall exhaust system performance, where "performance" can be measured by some acoustic descriptor such as the sound power radiated by the tail pipe outlet or the sound pressure at some point in space at a fixed distance from the tail pipe outlet. There seems to be mild confusion and some misunderstanding within the automotive industry on how the factors in Figure 1 interrelate in determining overall exhaust system performance. Yet, it is essential that we understand these effects if we are to develop a rational, workable test methodology suitable for muffler labeling. For example, if we know quantitatively how engine source impedance and source strength affect exhaust

system performance, we may possibly develop a bench-test methodology in which the engine is replaced with an electronic noise source such as an acoustic driver or loudspeaker. The data obtained from the bench test would be used to predict the overall exhaust system performance for any engine for which source impedance and source strength information are available. In a similar way we would like to account for variations in exhaust and tail-pipe lengths in order that a standard pair of pipes can be used for the bench test. Thus, by increasing our understanding of exhaust system behavior, we can develop a simplified test methodology suitable for muffler labeling.

We can divide the factors listed in Figure 1 into two categories: factors that can be accounted for using proven acoustical theory, and factors that must be accounted for with empirical data. Source impedance and source strength are examples of the latter category. On the other hand, pipes are classical acoustical systems, and the effect of pipe length and diameter on sound propagation and radiation is well known.

In general, muffler characteristics must be determined empirically, except for very simple geometries, in which case analytical results are reasonably accurate.

EXHAUST SYSTEM MODELING

Exhaust system modeling has evolved over a period of about 50 years since Stewart [2] analyzed muffler systems using lumped parameter approximations.* Davis et al. [4] made significant advances in exhaust system modeling by applying traveling-wave techniques to evaluate expansion chamber and side-branch

*Crocker [3] has recently reviewed exhaust system modeling.

configurations. Following this work, Igarashi [5] applied electrical four-pole techniques to exhaust system modeling. Recent developments in exhaust system modeling are reviewed by Sullivan [6].

The four-pole theory used by Igarashi is very powerful and easy to apply, and seems to be an ideal method for exhaust system design. Four-pole theory is based on the concept that in any linear, invariant system the input and output quantities can be related by four "system" parameters, called the "four-pole parameters." As an example, consider a straight section of pipe of length L and cross-sectional area S , Figure 2. The input and output quantities are the acoustic pressure and volume velocity at each end of the pipe. The expressions relating these quantities are:

$$P_1 = a_{11}P_2 + a_{12}V_2 \quad (1)$$

$$V_1 = a_{21}P_2 + a_{22}V_2 \quad (2)$$

where P_1 and V_1 are the acoustic pressure and volume velocity at the pipe entrance, and P_2 and V_2 are the acoustic pressure and volume velocity at the pipe exit. The four-pole parameters for the pipe-- a_{11} , a_{12} , a_{21} , and a_{22} --are functions of frequency, pipe diameter, and pipe length:

$$a_{11} = \cos kL \quad a_{12} = (\rho c/S)j \sin kL \quad (3)$$

$$a_{21} = (\rho c/S)j \sin kL \quad a_{22} = \cos kL$$

where $k=2\pi f/c$, c is the speed of sound, ρ is the density of air, and j denotes imaginary quantity.

For complex acoustical systems (e.g. a muffler) the four-pole parameters can be computed from measured impedances. It can be shown [7] that the four-pole parameters are related to the driving point and transfer impedances:

$$\begin{aligned} a_{11} &= z_{11}/z_{12} & a_{12} &= (z_{11}z_{22} - z_{12}^2)/z_{12} \\ a_{22} &= 1/z_{12} & a_{21} &= z_{22}/z_{12} \end{aligned} \quad (4)$$

where z_{11} and z_{22} are the driving point acoustical impedances looking into the acoustical system at the entrance and exit respectively, and z_{12} is the transfer impedance (defined as the ratio of the acoustic pressure P_1 at the entrance to the acoustic volume velocity V_2 at the exit). If we can measure the impedances of a complex system, then we will have the four-pole parameters for the system.

The four-pole theory is useful in combining acoustical subsystems, such as mufflers and pipes, to obtain overall system performance. This can be illustrated by representing an exhaust system in terms of four-pole parameters as shown in Figure 3. In Figure 3, z_e is the engine source impedance and V_e is the engine source strength (the acoustic volume velocity of the engine). The various subsystems are represented by cascaded four-pole parameters, and z_r is the radiation impedance of the tail pipe. For the four-pole model shown in Figure 3, V_e , z_e , and the muffler four-pole parameters must be obtained empirically; but the four-pole parameters

for the exhaust and tail pipes are given in Equation 3. The radiation impedance Z_r is known from theory (8).

Equations 1 and 2 can be written in matrix form:

$$\begin{bmatrix} P_1 \\ V_1 \end{bmatrix} = \begin{bmatrix} a_{11} & a_{12} \\ a_{21} & a_{22} \end{bmatrix} \begin{bmatrix} P_2 \\ V_2 \end{bmatrix} = \begin{bmatrix} A \end{bmatrix} \begin{bmatrix} P_2 \\ V_2 \end{bmatrix} \quad (5)$$

likewise, the relationship between acoustic pressure and volume velocity at the entrance and exit of the muffler can be expressed as:

$$\begin{bmatrix} P_2 \\ V_2 \end{bmatrix} = \begin{bmatrix} b_{11} & b_{12} \\ b_{21} & b_{22} \end{bmatrix} \begin{bmatrix} P_3 \\ V_3 \end{bmatrix} = \begin{bmatrix} B \end{bmatrix} \begin{bmatrix} P_3 \\ V_3 \end{bmatrix} \quad (6)$$

Equations 5 and 6 can be combined:

$$\begin{bmatrix} P_1 \\ V_1 \end{bmatrix} = \begin{bmatrix} A \end{bmatrix} \begin{bmatrix} B \end{bmatrix} \begin{bmatrix} P_3 \\ V_3 \end{bmatrix} \quad (7)$$

This process can be continued to yield:

$$\begin{bmatrix} P_1 \\ V_1 \end{bmatrix} = \begin{bmatrix} D \end{bmatrix} \begin{bmatrix} P_4 \\ V_4 \end{bmatrix} \quad (8)$$

where

$$\begin{bmatrix} P_1 \\ V_1 \end{bmatrix} = \begin{bmatrix} d_{11} & d_{12} \\ d_{21} & d_{22} \end{bmatrix} = \begin{bmatrix} A \\ B \\ C \end{bmatrix} \begin{bmatrix} P_4 \\ V_4 \end{bmatrix} \quad (9)$$

Because the four-pole parameters for A, B, and C are known (either from theory or experiment), the overall four-pole elements of the matrix D are also known. We can rewrite Equation 8 as:

$$P_1 = d_{11}P_4 + d_{12}V_4 \quad (10)$$

$$V_1 = d_{21}P_4 + d_{22}V_4 \quad (11)$$

We know also that $P_4/V_4 = Z_r$ and $V_1 = V_e - P_1/Z_e$. Combining these equations with Equations 10 and 11 to eliminate P_1 , V_1 , and V_4 yields:

$$P_4 = V_e Z_e / [Z_e (d_{21} + d_{22}/Z_r) + (d_{11} + d_{12}/Z_r)] \quad (12)$$

The insertion loss (IL) is a useful parameter for evaluating the acoustic performance of exhaust systems. One way to express insertion loss is to compare the acoustic pressure at the exhaust system exit (e.g. Equation 12) with the acoustic pressure P at the exit of the exhaust manifold when no exhaust system is present.

That is:

$$IL = 10 \text{ Log } \frac{|P|^2}{|P_4|^2} \quad (13)$$

The analogous circuit for the engine with no exhaust system is shown in Figure 4, where Z_r is the radiation impedance of the exhaust manifold. From Figure 4:

$$P = V_e \left(\frac{Z_r Z_c}{Z_r + Z_c} \right) \quad (14)$$

The insertion loss is found by combining Equations 12 and 14 with Equation 13.

$$IL = 20 \log \left| \frac{Z_c (d_{21} Z_r + d_{22}) + (d_{11} Z_r + d_{12})}{Z_c + Z_r} \right| \quad (15)$$

This equation shows clearly the relationship between the exhaust system variables and how each affects exhaust system performance.

MEASUREMENT OF ENGINE AND MUFFLER PARAMETERS

Equation 15 shows that we can predict exhaust system performance for a given combination of engine, muffler, and exhaust and tail pipes, providing we have the appropriate information. As mentioned previously, the four-pole parameters for the exhaust and tail pipes are known from theory, as is the radiation impedance Z_r , but the engine source impedance and the muffler impedances must usually be measured. This section will describe a novel method of impedance measurement. This method, referred to as the "two-microphone, random-excitation" technique was developed about two years ago by D. F. Ross and the author at the Ray W. Herrick Laboratories, Purdue University. The theoretical basis for the technique, as well as a

REST AVAIL 100 E 0000

literature survey of other techniques used to measure acoustical properties, is the subject of a recent paper [9]; only the practical aspects related to the measurement of exhaust system properties will be presented here.

The experimental setup used for the measurement of muffler properties is shown in Figure 5. With this arrangement, one can determine the muffler impedances from which the four-pole parameters for the muffler, b_{11} , b_{12} , b_{21} , and b_{22} , can be obtained (using equations like Equation 4). At the same time one can also determine other muffler parameters such as the transmission loss, the reflection coefficient, and the absorption coefficient. It should be emphasized, however, that these properties are not suitable for the prediction of overall exhaust system performance.

Referring to Figure 5, random noise is introduced into a pipe on one side of the muffler to be tested. Air flow may be introduced to simulate actual operating conditions, if necessary. Two microphones, located on the source side of the muffler and mounted flush with the inside of the pipe, sample the sound pressure. The microphones are separated a distance of approximately 50mm and located as close to the muffler as is physically possible (to minimize attenuation effects in the pipe). The microphone signals are digitized and stored in a Fourier Analyzer or Fast Fourier Transform (FFT) processor. A spectral processing technique [9] is used to decompose the sound field in the pipe into incident- and reflected-wave spectra. The muffler impedance and other muffler parameters can be determined from these spectra. To test the accuracy of the technique, the input impedance of a straight tail pipe was measured and compared with theory. Figure 6 shows the experimental and theoretical data of the real (resistive) and imaginary (reactive)

components of the tail pipe impedance. The excellent agreement between theory and experiment verifies the experimental technique and, at the same time, shows the accuracy of the theory [10]. This data supports earlier statements which noted that exhaust and tail pipe properties could be accounted for by using theoretical models.

In a second test the transmission loss of a prototype muffler was measured and compared to data obtained using the conventional standing wave ratio method. This data is presented in Figure 7; again, excellent agreement is noted.

Figure 8 shows how the two-microphone, random-excitation technique might be used to measure engine source impedance. The measurement of engine source impedance has not yet been demonstrated, but this and other work is underway at the University of Kentucky, Figure 9.

The two-microphone, random-excitation technique has several advantages over conventional methods of measuring acoustic properties. Conventional techniques such as the standing wave method [11] use traversing probe-tube microphones that are of complex design. In addition, flow-generated noise may influence microphone measurements made within exhaust pipes. The stationary, wall-mounted microphones used in the two-microphone, random-excitation technique avoid these problems. A second advantage is increased resolution. Because random excitation is used, the computed acoustical properties are essentially continuous in the frequency domain. With conventional methods using discrete frequency (sinusoidal) testing, data is also discrete, and important aspects of the acoustical properties (i.e.

occurring between test frequencies) can be overlooked. A third advantage is increased speed. Because random excitation is used, and because the data is acquired and processed automatically, impedance measurements are conducted rapidly. Only about 7 seconds of actual measurement time was needed to obtain the data in Figures 6 and 7.

The two-microphone, random-excitation technique is simple in design, and because the test is essentially a "hands off" test, the technique should yield highly consistent results. This is an important aspect of any testing technique that is to be used by a large number of individuals or groups in different regions of the country.

SUMMARY - A TEST METHODOLOGY FOR MUFFLER LABELING

The above discussion indicates that the insertion loss is a suitable parameter for predicting exhaust system performance. It is not practical to measure insertion loss for every engine and exhaust system configuration, but insertion loss can be predicted (e.g. Equation 15) using proven theory in conjunction with empirical data for engine and muffler impedances.

Much research remains before a test methodology suitable for muffler labeling can be implemented. For example, our knowledge of engine source impedance is quite incomplete. In predicting the insertion loss using Equation 15, how accurate must we know engine source impedance? Does engine source impedance depend on engine type? Load? Speed? The derivation of Equation 15 neglected the effects of flow and temperature gradients. How important are these effects in predicting insertion loss? Can these effects be included

using some type of "correction factors" or is a rigorous analysis called for here?

In conclusion, it appears that additional research is needed to answer some of these questions and to test the feasibility of using a semi-empirical test methodology, such as described in this paper, as a basis for muffler labeling.

REFERENCES

1. Federal Register, June 22, 1977, pp. 31722-31728.
2. Stewart, G. W., "Acoustic Wave Filters," Phys. Review, 20, 1922, p. 528.
3. Crocker, M. J., "Internal Combustion Engine Exhaust Muffling," Proceedings, Noise-Con '77, Washington, D.C., Oct. 17-19, 1977.
4. Davis, D. D. Jr., Stokes, G. M., Moore, D., Stevens, G. L., "Theoretical and Experimental Investigation of Mufflers with Comments on Engine Exhaust Muffler Design," NACA 1192, 1954.
5. Igarashi, J., Toyama, M., Fundamentals of Acoustical Silencers (I), Report No. 339, Aeronautical Research Inst., University of Tokyo, Dec. 1958, pp. 223-241.
6. Sullivan, J. W., "Modeling of Engine Exhaust System Noise," Noise and Fluids Engineering, R. Hickling, Ed., pp. 161-169.
7. Rschevkin, S. M., A Course of Lectures on the Theory of Sound, MacMillan Co., New York, 1963.
8. Levine, H., Schwinger, J., "On the Radiation of Sound from an Unflanged Circular Pipe," Phys. Review, 73 (4), 1948, pp. 383-406.
9. Seybert, A. F., Ross, D. F., "Experimental Determination of Acoustic Properties Using a Two-Microphone, Random-Excitation Technique," J. Acoust. Soc. Am., 61 (5), May 1977, pp. 1362-1370.
10. Morse, P. M., Ingard, K. U., Theoretical Acoustics, McGraw-Hill, 1968, Section 9.1.
11. ASTM C384-58, 1972, "Standard Method of Test for Impedance and Absorption of Acoustical Materials by the Tube Method."

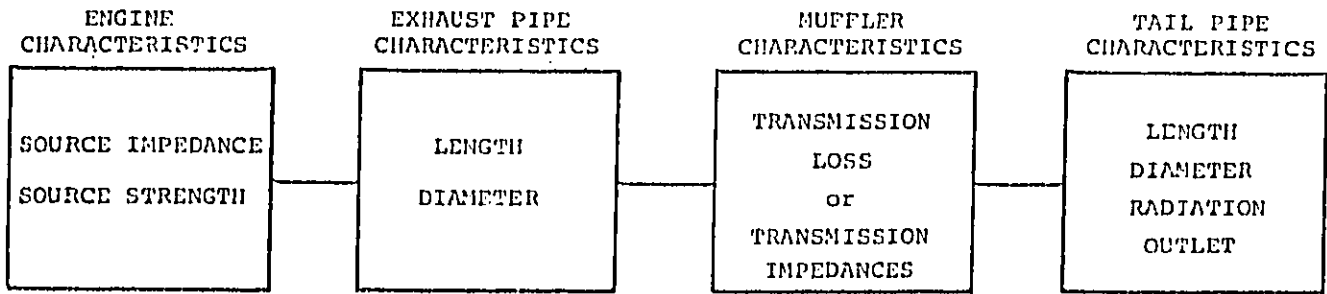

OTHER FACTORS:

1. Gas Flow
2. Temperature Gradients
3. Bends
4. Shell Radiation

Figure 1. Some factors influencing exhaust system performance.

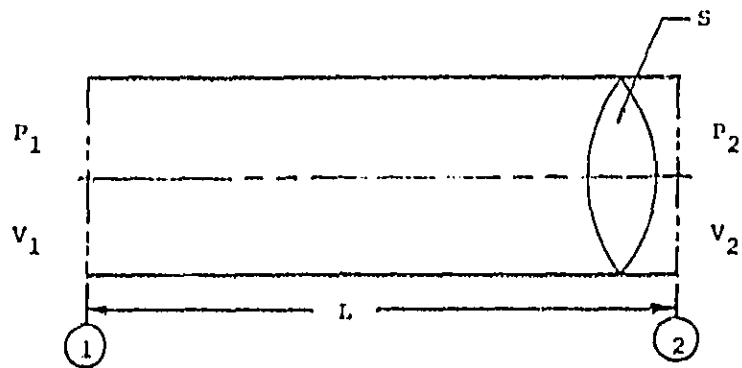

Figure 2. Straight pipe of length L , with acoustical variables P_1 and V_1 at the pipe entrance, and P_2 and V_2 at the pipe exit.

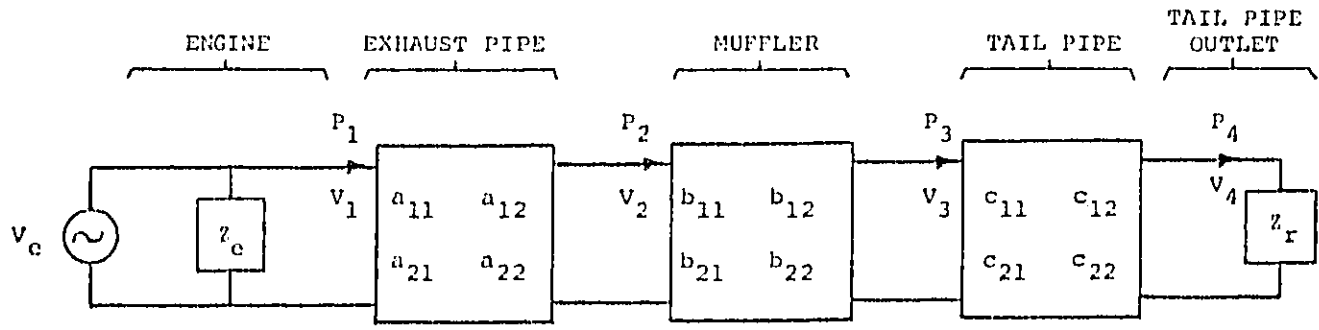

Figure 3. Representation of engine and exhaust system using four-pole theory.

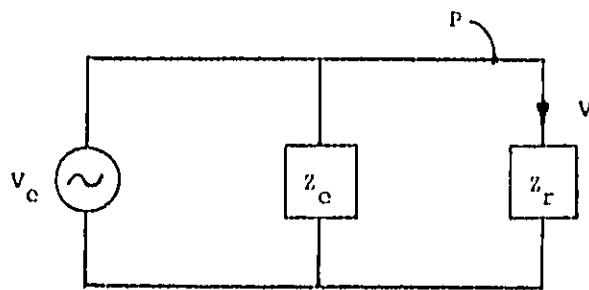

Figure 4. Model for engine and exhaust manifold without exhaust system.

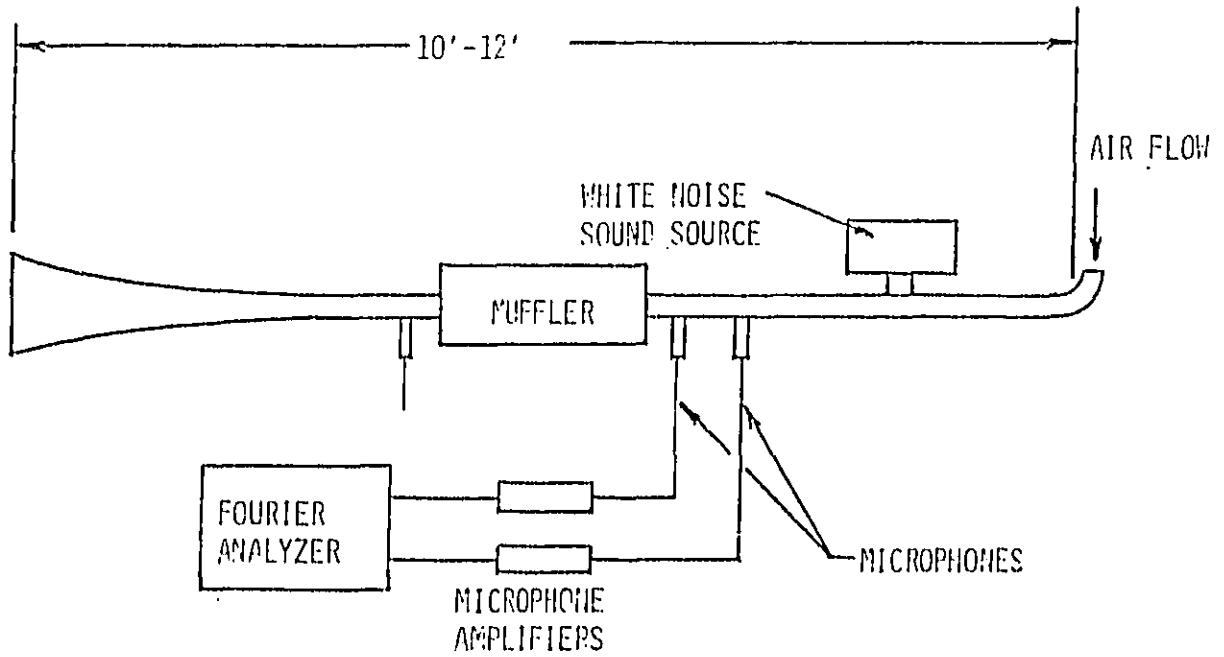

Figure 5. Measurement of muffler characteristics.

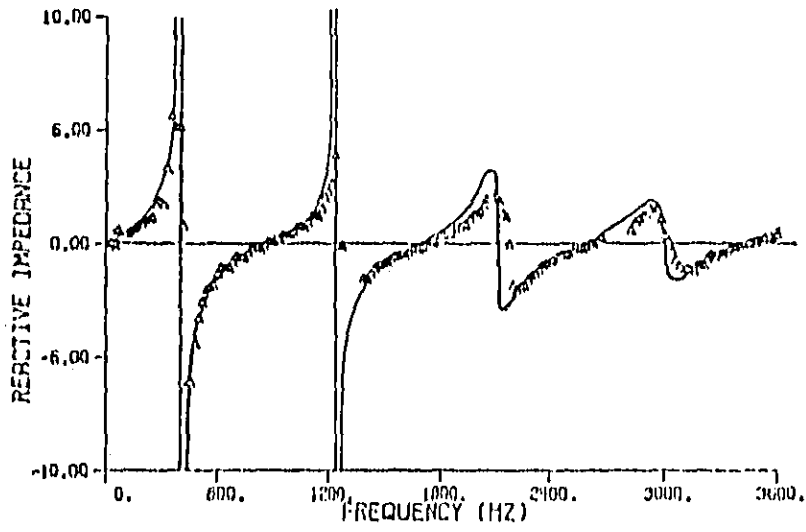
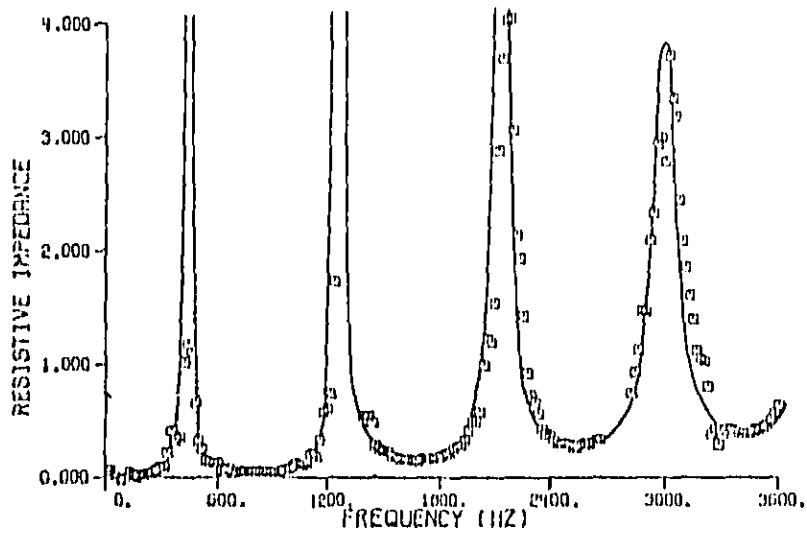

Figure 6. Resistive and reactive tail pipe impedances; solid line=theory; symbols=experiment.

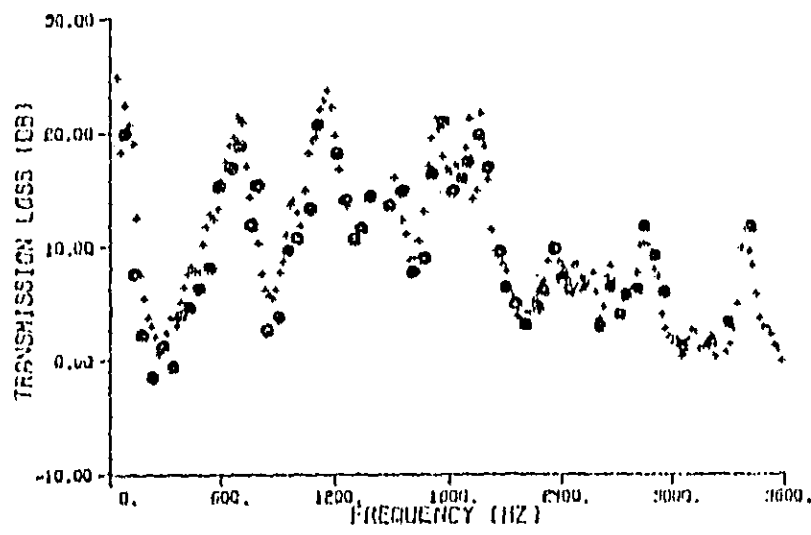

Figure 7. Transmission loss of prototype muffler; +two-microphone, random-excitation method; O=standing-wave method.

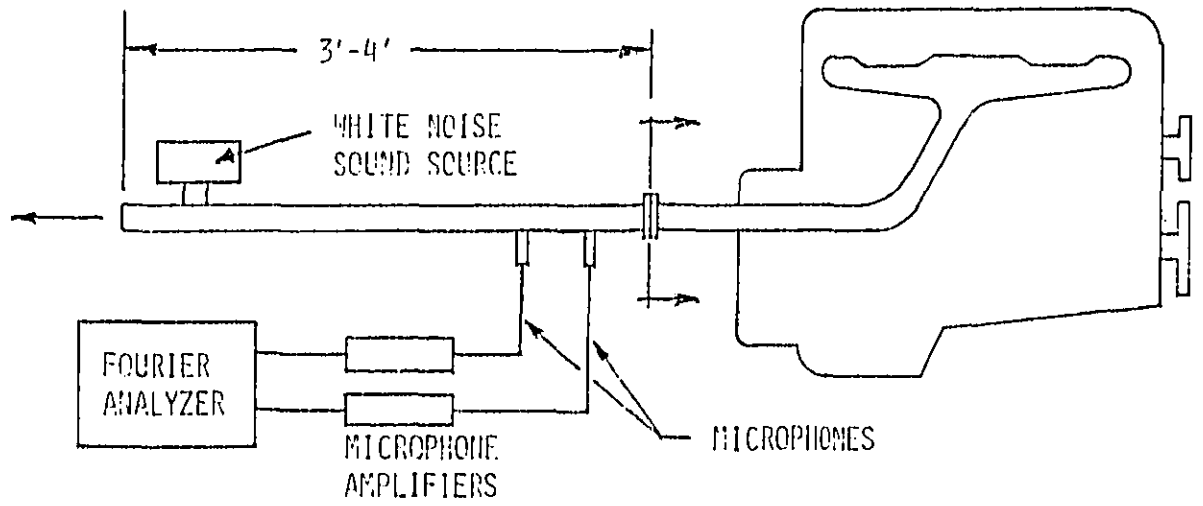

Figure 8. Measurement of engine source impedance.

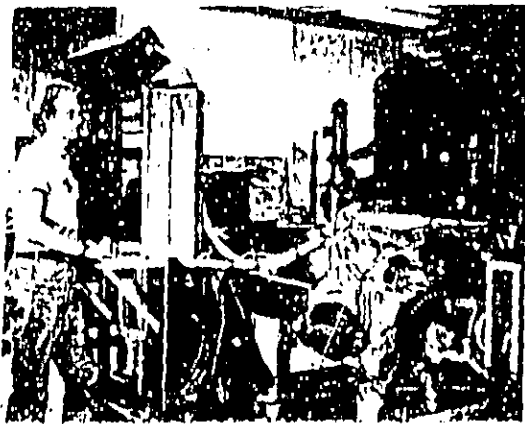

Figure 9. Internal combustion engine noise research at the University of Kentucky.

Analytical and Experimental Testing
Procedures for Quieting Two-Stroke Engines

by

Donald L. Margolis
Assistant Professor

Dean C. Karnopp
Professor

and

Harry A. Dwyer
Professor

Department of Mechanical Engineering
University of California
Davis, California 95616

Abstract

The results of a research effort sponsored by Yamaha Motor Co. of Japan are presented. The main objective of the project was to quiet the exhaust from 2-stroke engines without sacrificing (too much) performance.

Analytical and experimental programs were undertaken to acquire a fundamental understanding of 2-stroke engine dynamics, to measure and predict noise levels associated with various exhaust systems, and to design innovative muffling systems. The results show that predicting absolute noise levels is difficult; however, comparative studies are well suited to analytical techniques.

Primary emphasis is placed on experimental procedures which allow testing of mufflers in an anechoic chamber and in the absence of an operating engine. One of these is a positive displacement acoustic level source to which mufflers can be attached and sound power levels determined. This procedure was used to corroborate acoustic theory and to determine the extent to which acoustic theory could be used in the design of engine mounted mufflers.

Another procedure involves the use of a rotary valve and compressed air to generate very realistic (motorcycle-like) large amplitude pulses with the proper through-flow and frequency content. This very clean experiment has proven to be a very excellent method for duplicating actual engine tests. It is anticipated that further development will result in a variable displacement, variable through-flow rotary valve air motor that can be used to accurately assess real muffler performance.

Introduction

Under sponsorship of Yamaha Motor Company of Japan, a research effort was initiated at the University of California, Davis to study exhaust silencing of two-stroke engines. The three authors were coinvestigators on the project. The project resulted in several publications (refs. [1]^{*} through [7]), two patents for Yamaha, and supported several graduate research assistants.

The principal objective of the effort was to quiet two-stroke engine exhausts without sacrificing performance. To accomplish this goal, the research was channeled into several-parallel paths. One of these involved a major analytical and experimental study of the gas dynamics and mechanical dynamics of the two-stroke engine in order to gain a fundamental understanding of its operation and why it produces (so much) noise in the first place. This study is representative of refs. [1], [4], [5], [6], [7]. Another major research channel involved analytical modeling and experimental testing of mufflers in the University of California, Davis anechoic chamber. This aspect is described in refs. [2] and [3].

In the following section the operation of a two-stroke engine will be briefly described in order to gain a qualitative understanding of the noise generation problems involved. Following this, the analytical engine and exhaust modeling are described in some detail along with noise prediction models. Finally, the analytical and experimental anechoic chamber tests are presented and the entire project summarized with emphasis on regulatory tests for EPA monitoring and control of motorcycle noise.

*Numbers in brackets [] refer to references

Two-Stroke Engine Operation

The two-stroke engine is shown schematically in figure 1 for two different crank positions. The associated conventional expansion chamber is shown in figure 2. Assuming a fresh charge of air/fuel mixture has just been ignited, the piston is driven downward on its power stroke. It first uncovers the exhaust port (EP) and most of the exhaust gasses are forced into the exhaust pipe due to the still relatively high pressure inside the cylinder. Also, as the piston moves down, it compresses the fresh charge of fuel already resident in the crankcase. As the transfer port (TP) is uncovered this fresh mixture is forced through the transfer passages and into the cylinder above the piston. As the piston moves upward from bottom dead center (BDC) it first uncovers the inlet port (IP) and fresh mixture flows into the crankcase as a result of the increasing crankcase volume. The piston then covers the TP and finally the EP and compresses the remaining fresh charge in readiness for the next spark ignition.

Some of the factors influencing the overall engine performance are the amount of fresh charge inducted through the IP, the amount of fresh charge pushed through the TP, and the amount of fresh charge that leaks out through the EP prior to EP closure. These considerations are what make the two-stroke engine a most interesting dynamic system. Qualitatively, it is the "inertia" of the gasses in the intake passage and transfer passage that insure proper charging of the combustion chamber, and it is the expansion chamber that controls the loss of fresh charge into the exhaust system.

When the exhaust gasses are forced through the EP, a large amplitude pressure wave begins propagating down the exhaust system (see fig. 2). As this wave passes through the "diverging cone", a negative (or rarefaction) wave propagates back upstream and helps empty the cylinder of exhaust gasses. This process is called scavenging. When the pressure wave reaches the "stinger", most of

the energy is reflected and this returning pressure wave either pushes fresh charge back into the cylinder or prevents too much from leaking away. This "stuffing" phenomenon of course depends on engine RPM, exhaust system length and various other system parameters. From the point of view of performance this type of expansion chamber can provide significant supercharging of the combustion chamber. From the point of view of noise, the straight through-flow expansion chamber is perhaps the worst possible design.

In the following section the analytical modeling of two-stroke engines and their exhaust systems is described along with noise prediction.

Analytical Models for Performance and Noise Prediction

The model used for performance prediction is described in ref. [5]. Since performance is not the main consideration here, this model will not be described in great detail. It consists basically of a bond graph [8] model of the complete engine coupled with an approximate model of the exhaust system. Dynamic considerations include the intake, exhaust, and transfer passages as well as crankcase compression and combustion. The model is ideal for performing extensive parametric studies of port timing, port geometry, crankcase volume, exhaust system dimensions, etc. The operation and capability of the model are discussed completely in ref. [5].

Of more importance with respect to noise prediction is the gas dynamic modeling of the exhaust system. The gas flow was assumed to be one-dimensional and time dependent. The equations of motion describing this flow are

$$\frac{\partial}{\partial t}(\rho A) = \frac{\partial}{\partial x}(\rho u A) \quad (\text{Continuity})$$

$$\frac{\partial}{\partial t}(\rho u A) = - \frac{\partial}{\partial x}(\rho u^2 A + p A) + p \frac{dA}{dx} - \rho A F \quad (\text{Momentum})$$

$$\frac{\partial(Es)}{\partial t} = - \frac{\partial}{\partial x} (u(Es + PA)) - \text{Work} \quad (\text{Energy})$$

$$Es = \rho A(C_v T + u^2/2)$$

$$p = \rho R T$$

where p , ρ and T are the thermodynamic properties pressure, density and temperature; u - the fluid velocity; A - channel area; t - time; x - position; C_v - specific heat at constant volume; and R the gas constant. The frictional losses have been included in the term $\rho A F$ where F is given by the

following expression

$$F = \frac{4f}{D} \frac{u^2}{2} \frac{u}{|u|}$$

(f and D are the friction factor and diameter respectively). The procedure for solving the above equations is given in ref. [1] where all unusual circumstances such as boundary conditions and internal choking are discussed. For an average case, 150 spatial node points, similar to figure 2 were used throughout the engine and exhaust system and 800 time steps were needed to complete one engine cycle. As can be surmised from the above comments and equations the numerical simulation is very complete and general, and capable of good spatial and time resolution. The spatial and time resolution is extremely important for making noise predictions since high frequency waves and large sound speeds are common in two-stroke engines.

The model is capable of predicting pressure, flows, temperature, etc. throughout the entire exhaust system; however, for the purpose of this paper only results associated with the "stinger" will be presented (see figure 2). Also, all results are for a Yamaha 360 MX engine.

Figure 3 shows the predicted volume flow rate from the "stinger" into the atmosphere for the engine operating at full throttle, under load, at 7000 RPM. This is approximately the maximum power RPM for the 360 cc engine. The steep fronted wave in the center of the figure is the dominant cause of the very loud, high frequency snap associated with two-stroke engines. This is also apparent from figure 4 where pressure and velocity inside the stinger section are shown. Pressure in excess of two atmospheres is predicted with velocity surges in excess of 450 m/s. If we assume that any realistic muffling device will not change the engine performance too much, then we see that extremely large amplitude, high frequency waves will exist at the muffler entrance.

This suggests that the type of nonlinear modeling presented here is essential for accurate prediction of muffler performance for small, high performance power plants.

To predict exhaust noise levels for this engine, the volume velocity of figure 3 was assumed to be that of a simple source radiating into an anechoic far field. The pressure predicted at 50 feet from the source was digitally transformed into a frequency spectrum and is shown in figure 5. An A-weighted sound scale was assumed. A significant characteristic of the spectrum is that it is relatively flat and contains a broad band of frequencies. Also, there is very substantial contribution from frequencies over 1000 cycles per second. The total SPL, weighted for the A scale, that is associated with the spectrum is 102.85 db for 50 feet from the simple source. This number is in good agreement with SPL measurements on unmuffled expansion chambers.

The next results to be presented are concerned with the addition of mufflers to the exhaust system. In figure 6 is shown the geometry of two mufflers analyzed. The nonlinear muffler shown in the top of figure 6 was analyzed with the new methods mentioned previously, while the lumped parameter muffler was analyzed with classical acoustical type approximations. In figure 7 the volume flow rate out of the nonlinear muffler is shown. It can easily be seen by comparing with figure 3 for the unmuffled case that considerable smoothing has occurred due to the muffler. However, there is a very distinct and regular high frequency variation in the flow. This regular variation is due to the reflection and formation of waves in the muffler itself, and the frequency is characteristic of the muffler dimensions and gas sound speed. This frequency and its harmonics are very evident in the sound square spectrum shown in figure 8. It is also apparent from the spectrum that frequencies below 1000 cycles/sec and very high frequencies have been substantially attenuated.

The overall SPL for the nonlinear muffler is 95.8, which is less than the unmuffled case, but still not very liveable.

One of the primary reasons for solving the lumped parameter muffler was to compare with the nonlinear case and to make an assessment of the quantitative value of standard acoustical approximations. In the modeling of the lumped parameter muffler the system is represented by two volumes, two nonlinear resistances and two inertias and this system is solved simultaneously with the flow in the engine and expansion chamber. The volume flow rate from the lumped parameter muffler is shown in figure 9 and it is seen to be extremely smooth. The spectrum shown in figure 10 illustrates that all frequencies have been suppressed by the lumped parameter muffler and the SPL was 58.9 db. Since the dimensions of the nonlinear and lumped parameter muffler are very similar it must be concluded that the use of the lumped parameter analysis for the large amplitudes waves in two stroke engines is questionable. The one region of the spectrum where there is qualitative agreement between the two mufflers is in the low frequency part of the spectrum.

Another important interaction between the muffler and exhaust system that should be mentioned is the influence of back pressure caused by frictional losses on the transfer of gasses into and out of the engine cylinder. For both the mufflers analyzed there was enough back pressure to cause a significant amount of exhaust gasses to be left behind in the engine cylinder.

The mufflers analyzed here are quite primitive; however, the new technique employed reveals some interesting physical processes which are not included in classical approaches to the subject. The simple source assumption used to convert exit volume flow rate into a SPL prediction proved to be quite accurate when compared to actual drive-by tests (see ref. [4]). Further development of the nonlinear analysis discussed here seems to offer the hope of gaining considerably greater insight into the nonlinear physical processes in mufflers and two-stroke engine expansion chambers.

The Experimental Program

Coupled closely to the analytical effort, the experimental program was designed to first corroborate, in so far as possible, the computer models developed for performance and noise prediction. This aspect of the program is discussed thoroughly in refs. [3], [4], [5], [6], and [7]. At this time this corroborative experimentation is not directly applicable to muffler evaluation and will not be discussed further.

Another aspect of the experimental program was the design of procedures and devices for evaluating mufflers in the University of California, Davis anechoic facility. The main purpose of these experiments was to test muffler models designed from acoustic considerations and to compare muffler devices subject to realistic large amplitude inputs. Two experimental apparatus were developed. These are described next.

Acoustic Filter Apparatus

The acoustic filter apparatus was designed to test mufflers subject to small amplitude volume flow inputs. This device is shown schematically in figure 11 and pictorially in figure 12. Basically it consists of a high impedance electromagnetic shaker driving a piston and this producing a known frequency dependent flow source. As shown in figures 11 and 12, the shaker and piston are enclosed in a thick wall pipe to prevent acoustic leakage. The device could be modified to include mean flow but at this time no mean flow is available. This device is perfect for measuring insertion loss of muffling schemes; however, it is restricted to small amplitude input and correlation with actual muffler performance is questionable.

Large Amplitude Simulator Apparatus

In order to use the anechoic facility to test mufflers subject to realistic input, the apparatus of figures 13 and 14 was developed. It consists of a high pressure supply to a plenum chamber which feeds one side of a rotating cylinder driven by a 1/15 horsepower electric motor. The inside cylinder has a port which allows charging with high pressure air as the port rotates past the plenum opening and then subsequent discharging as the port uncovers the exhaust opening. This simple device, when connected to a stock Yamaha 360 MX expansion chamber produces pressure spectra which are virtually identical to that shown in figure 5.

Thus far, the rotary valve has been used for qualitative comparison studies of various muffling schemes and has proven 100% effective with respect to comparison noise studies of actual motorcycle tests. It was not attempted to duplicate quantitative results as this was not essential for the Yamaha project. However, there is no fundamental reason why the rotary valve could not be used to produce quantitative comparisons of anechoic chamber versus actual motorcycle tests. It appears that attention need only be given to exhaust pulse amplitude, volume through-put, and gas temperature in order to obtain quantitative comparisons.

The question of performance degradation associated with various muffling devices is not as easy to infer from the bench tests as was the noise comparisons. Again, however, it appears that if some attention is given to this specific problem, there is no fundamental reason why correlation cannot be obtained.

DEPT AVIATION AND SPACE

Does a bench test procedure exist for certifying motorcycle exhaust system performance with respect to noise and performance constraints?

At the present time, such a procedure does not exist. However, it is felt that rotary valve is a candidate for development into a dependable, inexpensive, and fast procedure for evaluating, at the very least, two-stroke engines for motorcycles and snowmobiles. It is also anticipated that small, four-stroke power plants can be tested in a similar fashion. What is required is a research effort directed specifically at the certification issue and relying heavily on the research results already developed.

List of Figures

- Fig. 1 Schematic of a two-stroke engine.
- Fig. 2 Conventional expansion chamber.
- Fig. 3 Predicted volume flow rate from "stinger" of unmuffled 360 MX at 7000 RPM.
- Fig. 4. Predicted pressure and velocity inside the "stinger" for unmuffled 360 MS at 7000 RPM.
- Fig. 5. Pressure squared frequency spectrum resulting from Fig. 3.
- Fig. 6. Muffler geometries.
- Fig. 7. Exit volume flow rate for the nonlinear muffler.
- Fig. 8. Pressure squared spectrum resulting from the flow of Fig. 7.
- Fig. 9. Exit volume flow rate for the lumped parameter muffler.
- Fig. 10. Pressure squared spectrum for volume flow of Fig. 9.
- Fig. 11. Schematic of the acoustic filter apparatus.
- Fig. 12. The acoustic filter apparatus set-up in the anechoic chamber.
- Fig. 13. Schematic of rotary valve.
- Fig. 14. Rotary valve set-up in the anechoic facility.

References

- [1] Dwyer, H., Allen, R., Ward, M., Karnopp, D., and Margolis, D., "Shock Capturing Finite Difference Methods for Unsteady Gas Transfer", AIAA Paper No. 74-521, AIAA 7th Fluid and Plasma Dynamics Conference, Palo Alto, CA., June, 1974.
- [2] Karnopp, D., Reed, J., and Margolis, D., "Design and Testing of Reactive Mufflers", Proc. of the 1974 International Conference on Noise Control Engineering, Institute of Noise Control Eng., pp. 325-330.
- [3] Karnopp, D., Reed, J., Margolis, D., and Dwyer, H., "Computer-Aided Design of Acoustic Filters using Bond Graphs", Noise Control Engineering, Vol. 4, No. 3, May, 1975.
- [4] Karnopp, D.C., Dwyer, H., and Margolis, D.L., "Computer Prediction of Power and Noise for Two-Stroke Engines with Power-Tuned, Silence Exhausts", SAE Paper 750708, August, 1975.
- [5] Margolis, D.L., "Modeling of Two-Stroke Internal Combustion Engine Dynamics Using the Bond Graph Technique", SAE Transaction, September, 1975, pp. 2263-2275.
- [6] Kelsay, R.E., and Margolis, D.L., "An Experimental Investigation of Two-Stroke Internal Combustion Engine Performance", SAE Transaction, 1975, pp. 2251-2262.
- [7] Ospring, M., Karnopp, D., and Margolis, D.L., "Comparison of Computer Predictions and Experimental Tests for Two-Stroke Engine Exhaust Systems", SAE Paper 760172, February, 1976.
- [8] Karnopp, D.C., and Rosenberg, R.C., *System Dynamics: A Unified Approach*, John Wiley and Sons, New York, 1975.

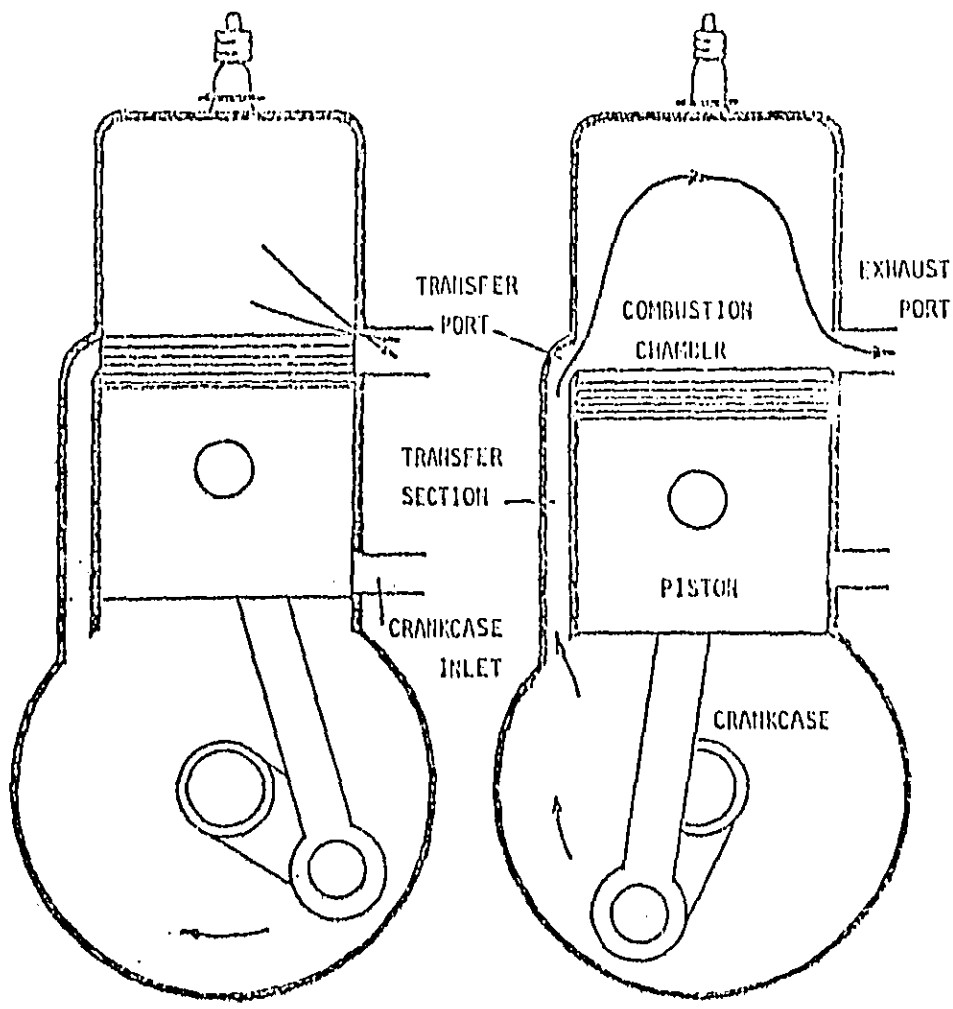

SCHEMATIC DIAGRAM OF TWO STROKE ENGINE OPERATION

Figure 1

BEST AVAILABLE COPY

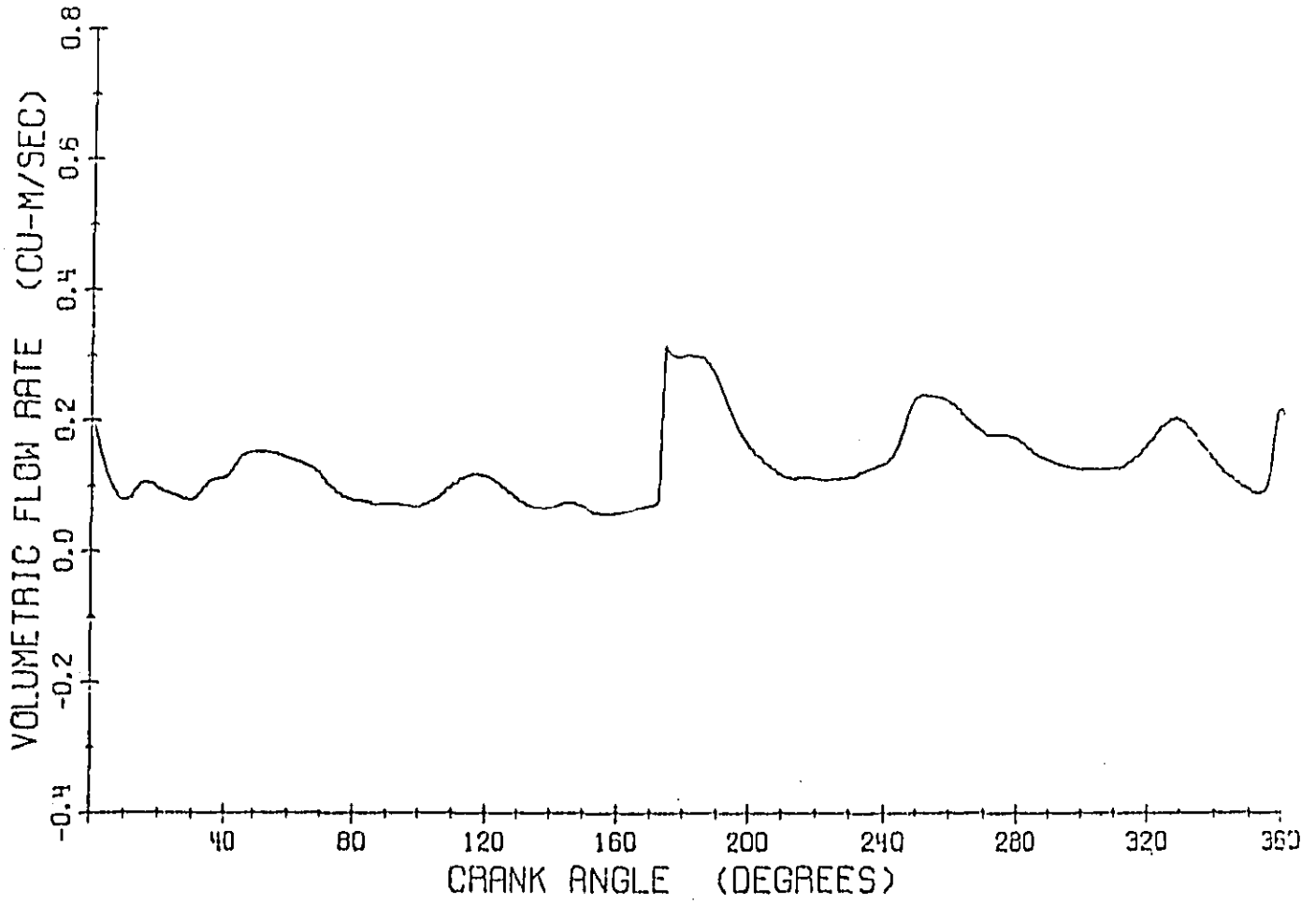

360 MX- 7,000 RPM

FIGURE 3

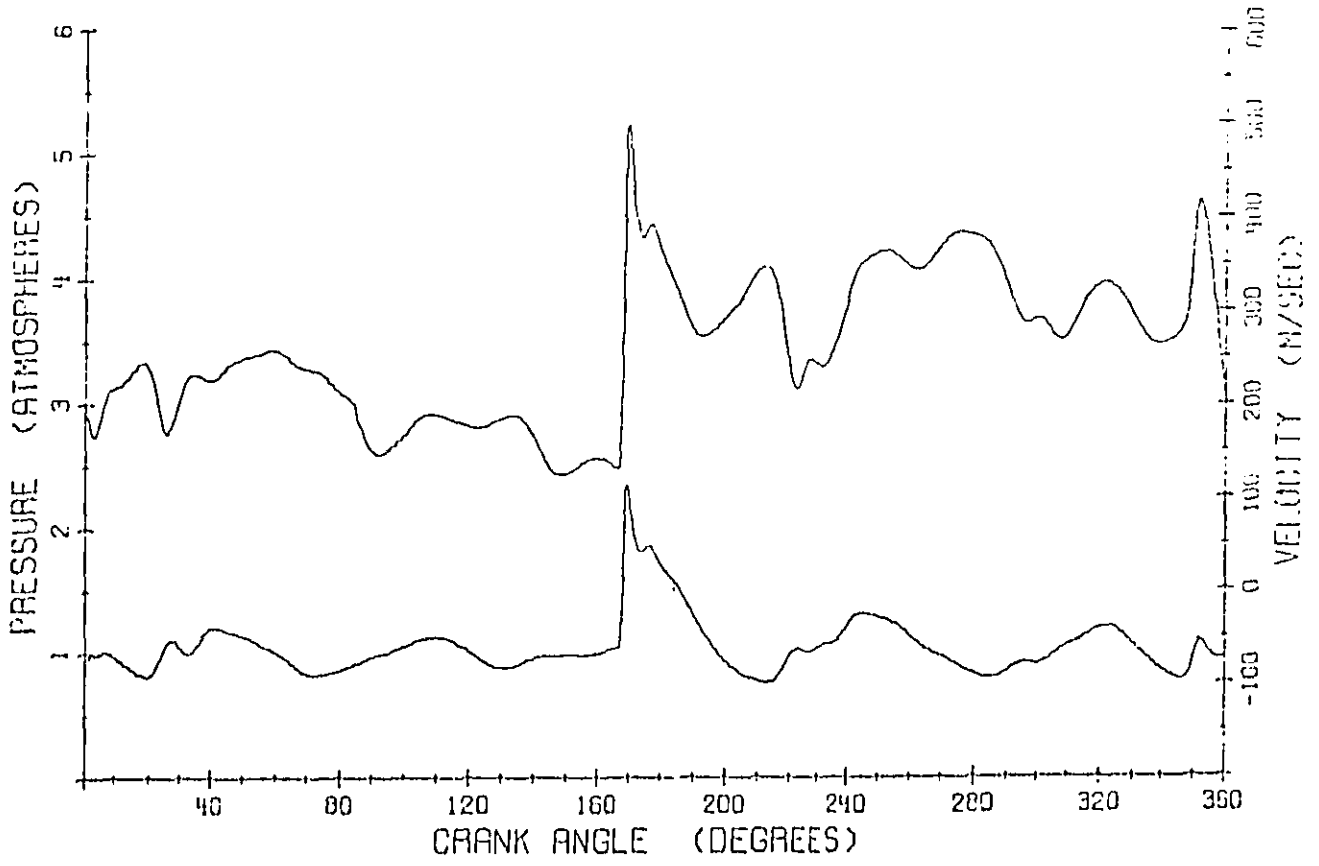

360 MX- 7,000 RPM

FIGURE 4

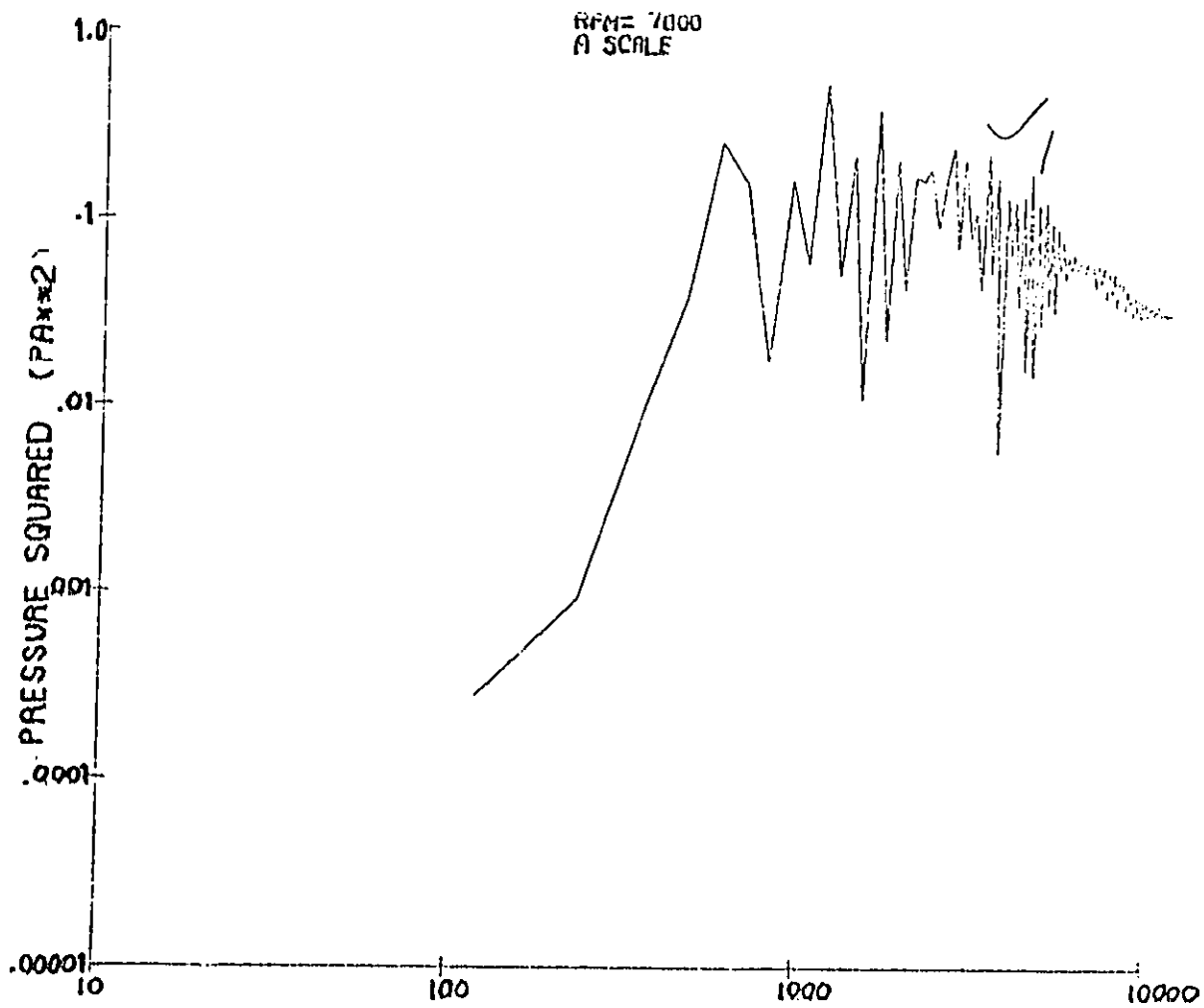

FIGURE 5

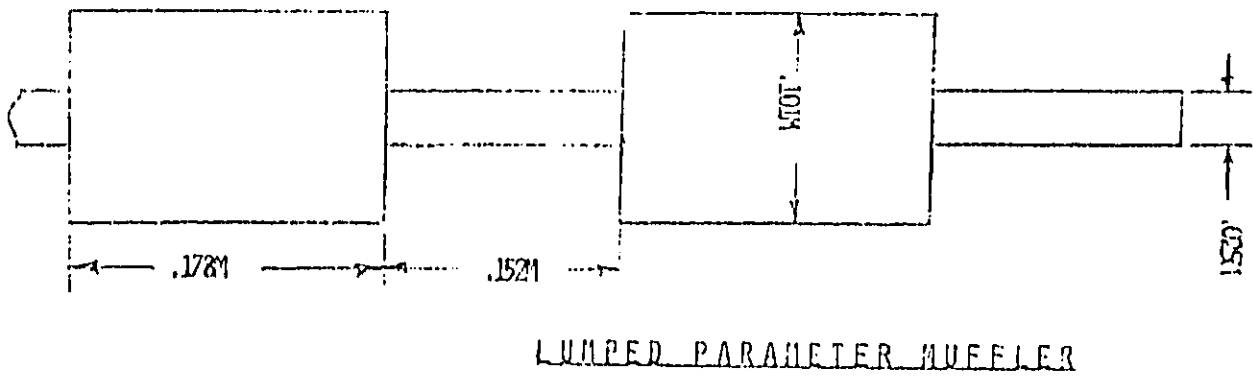
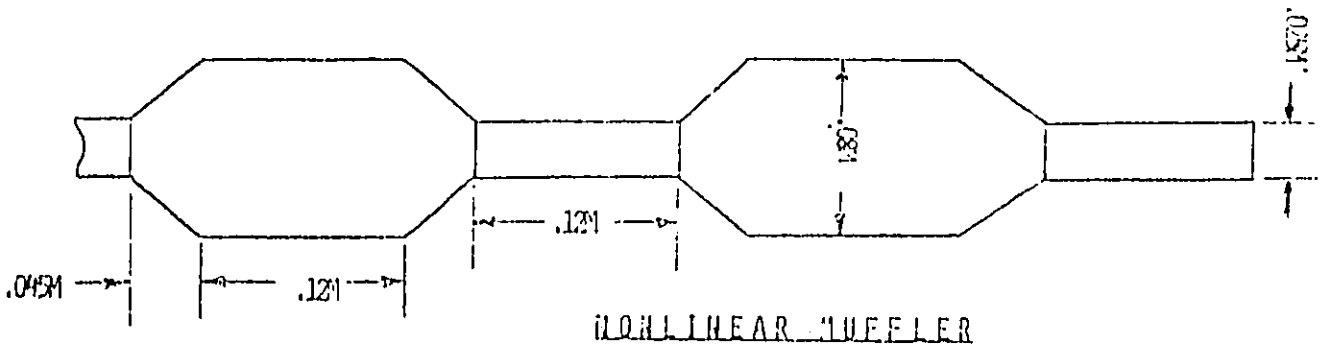
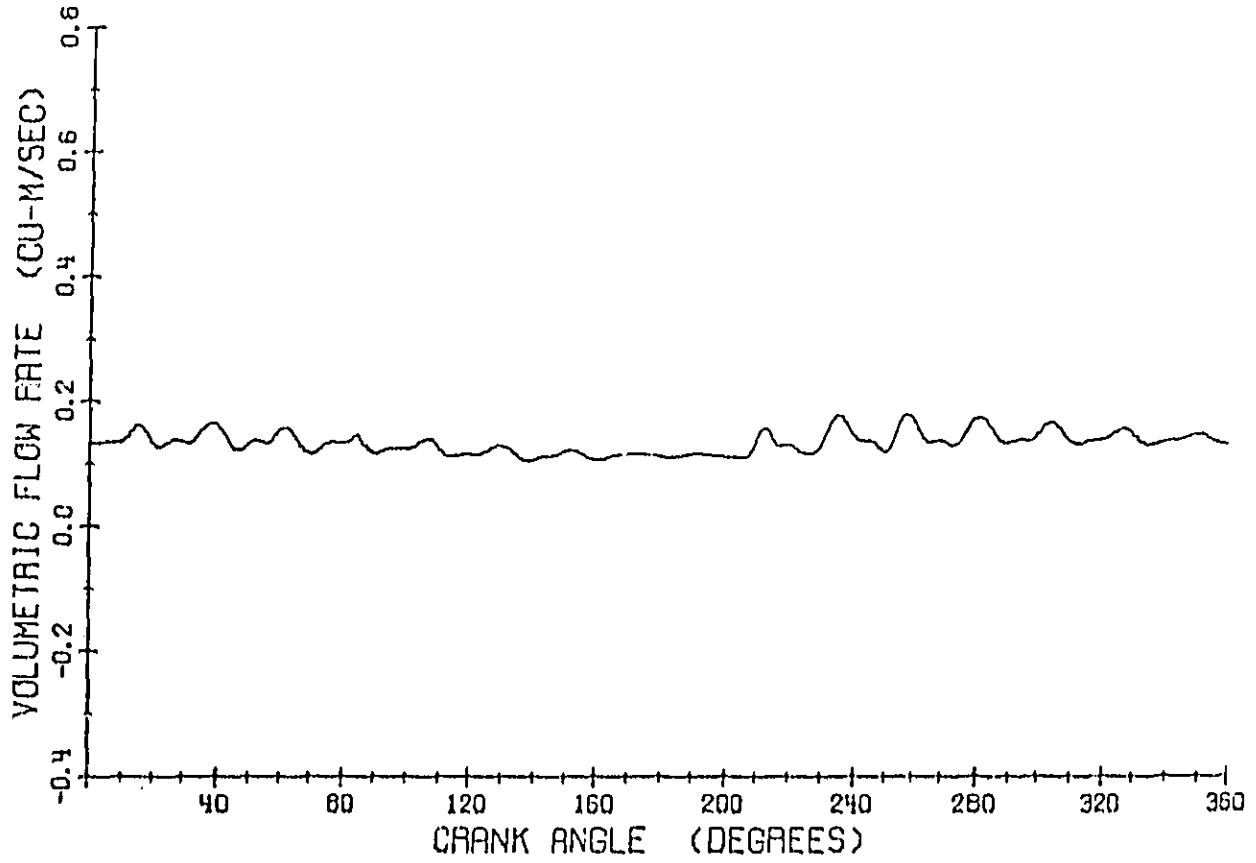
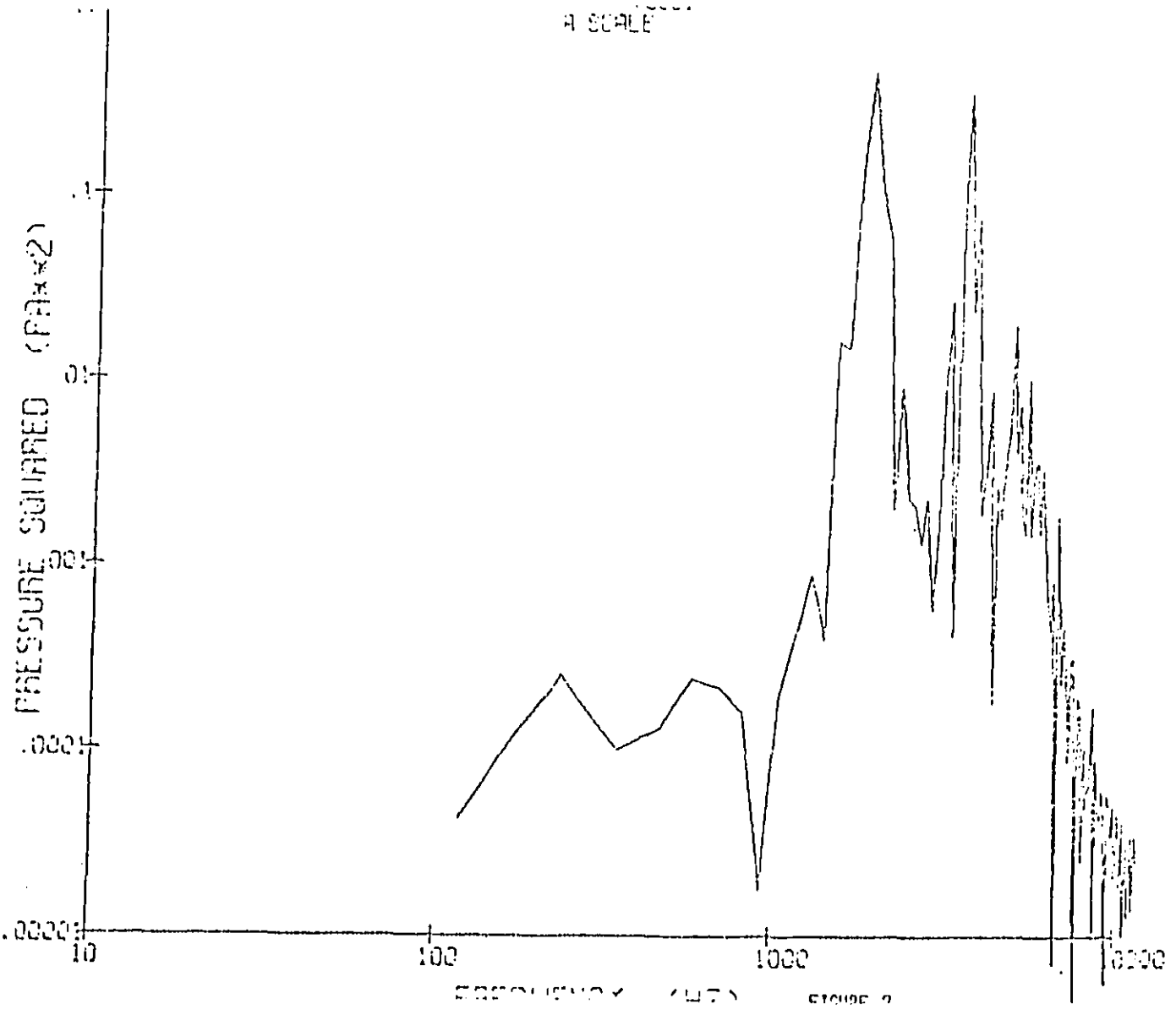

FIGURE 6



360 MX- 7,000 RPM

FIGURE 7



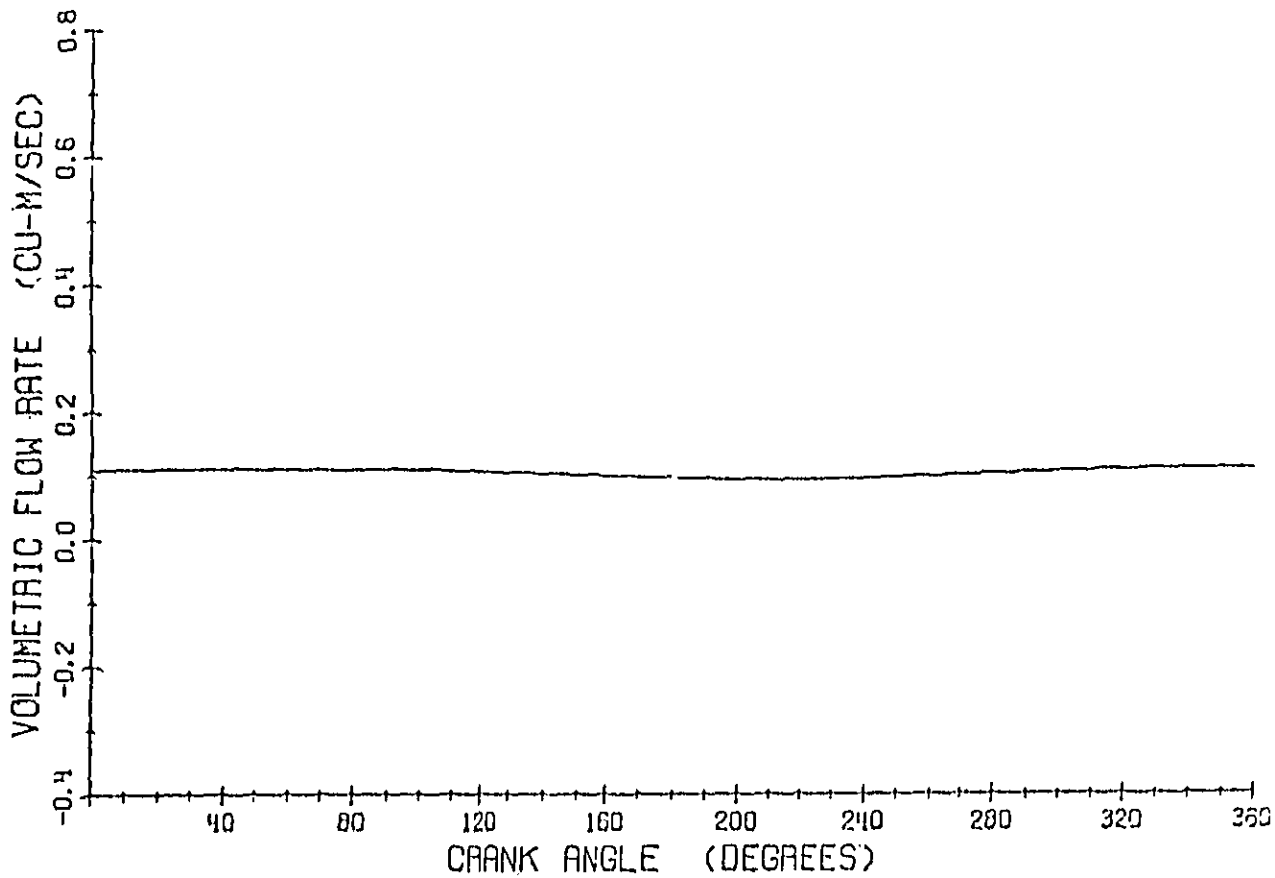

360 MX-7,000 RPM

FIGURE 9

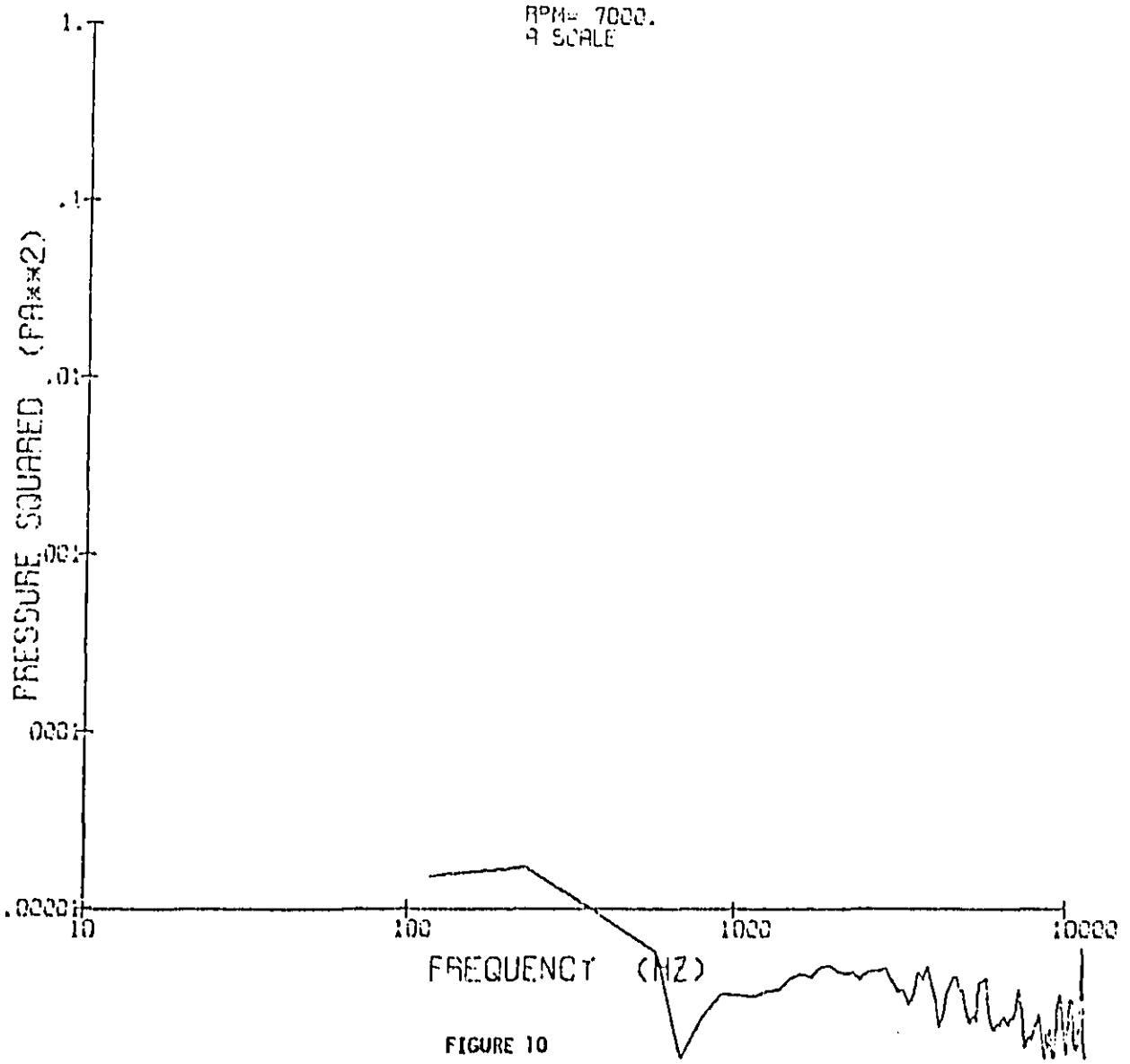

228

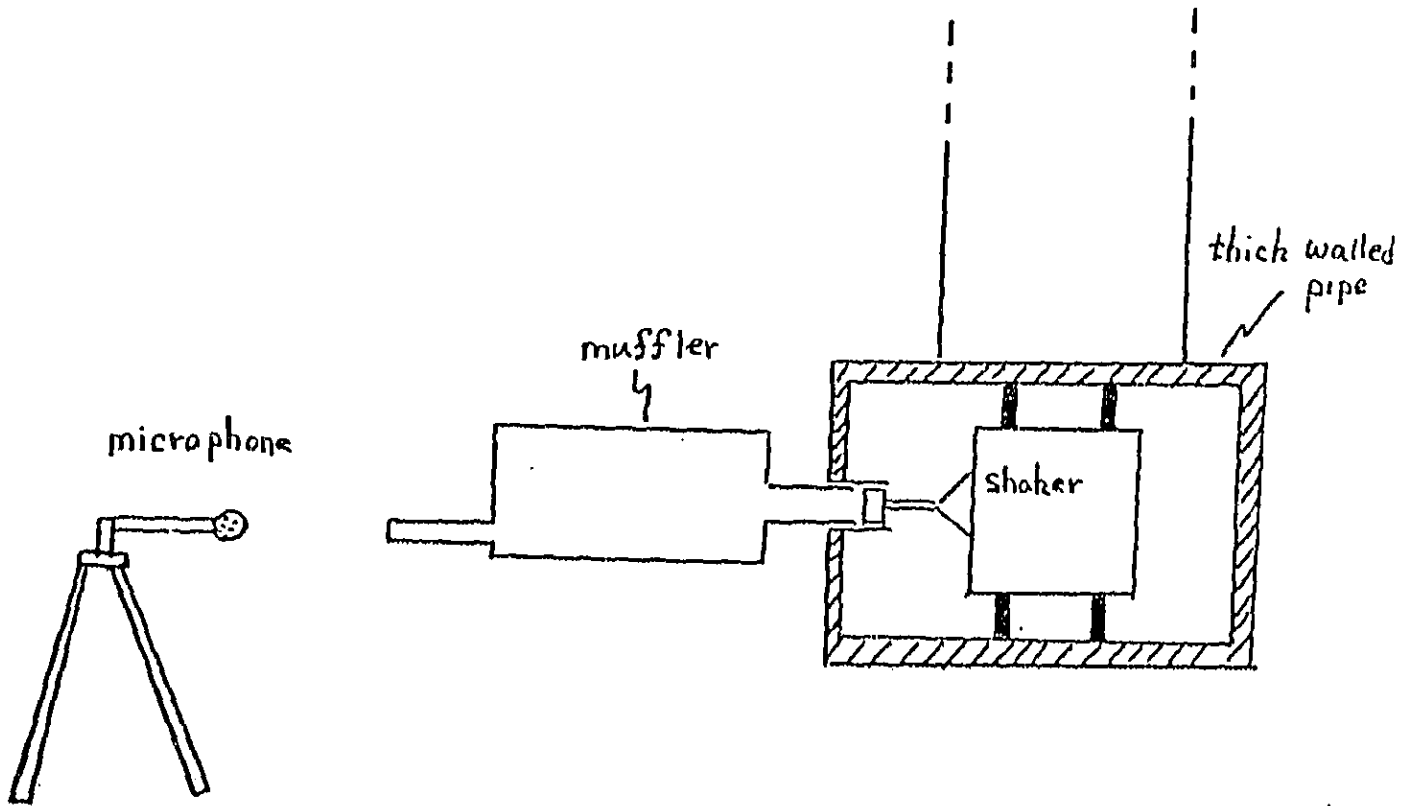

FIGURE 11

BLACK COPY

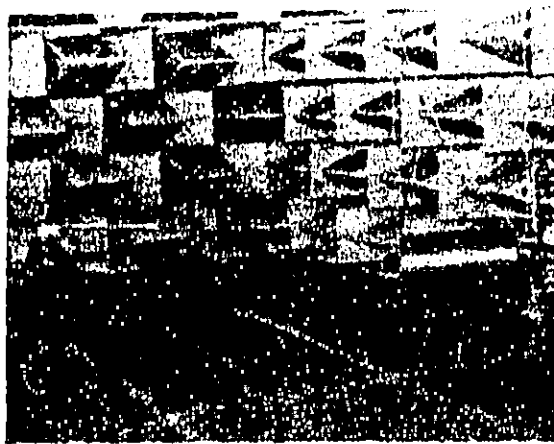
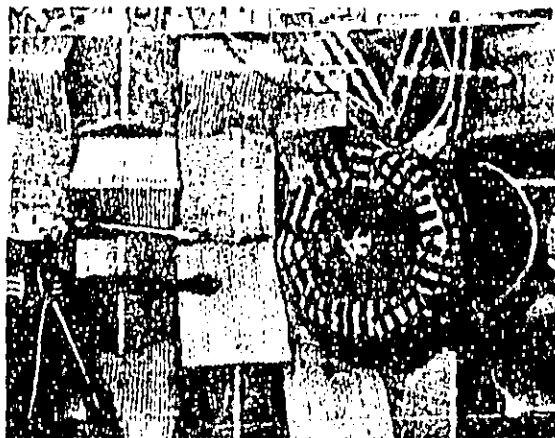

FIGURE 12 229.

BEST AVAILABLE COPY

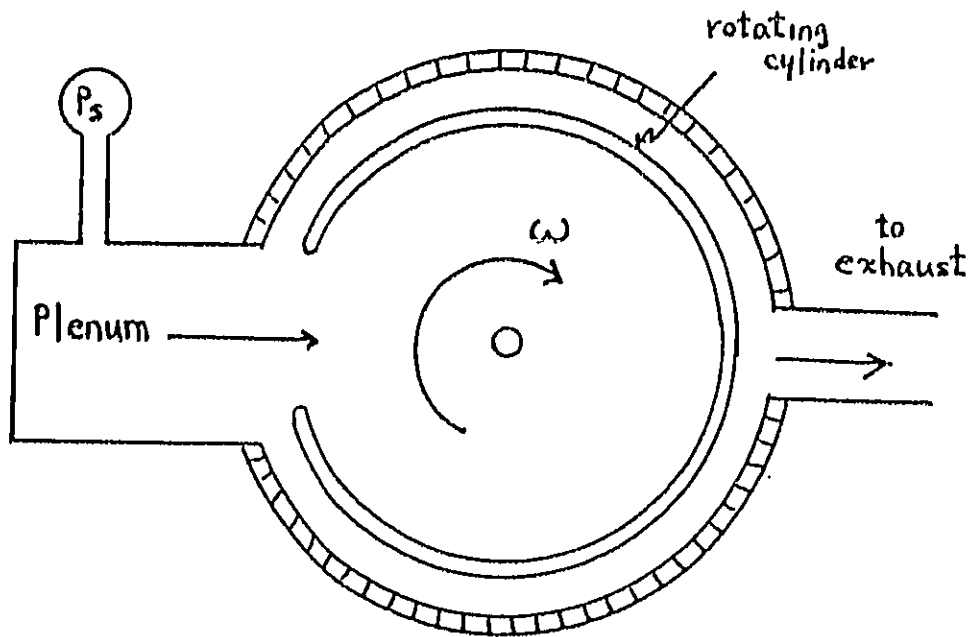
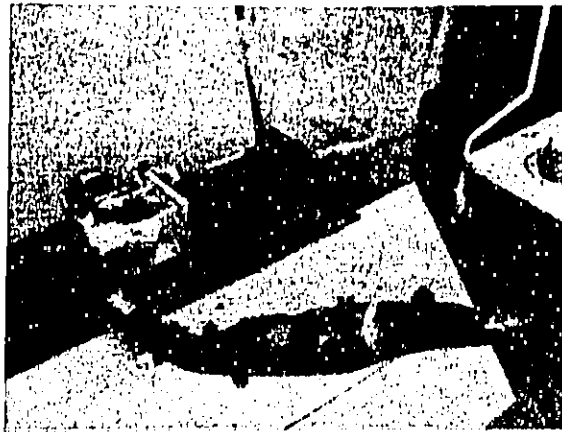
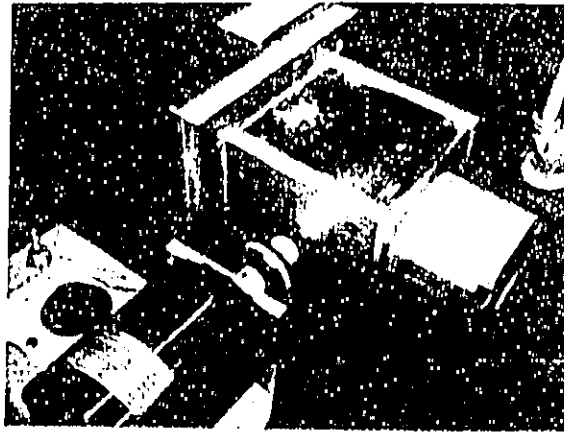

FIGURE 13



BLACK COPY

POWER OR PRESSURE - A DISCUSSION OF CURRENT ALTERNATIVES IN
EXHAUST SYSTEM ACOUSTIC EVALUATION

by

Larry J. Eriksson
Nelson Industries, Inc.
Stoughton, WI 53589

Presented at the
United States Environmental Protection Agency
Surface Transportation Exhaust Noise Symposium
Chicago, Illinois
October 11-13, 1977

ABSTRACT

Various procedures for the evaluation of exhaust system performance are presented and discussed. Analytical as well as experimental techniques are considered. Comparisons are made with measurements on actual engine exhaust noise. The major approaches are ranked with respect to accuracy and cost.

INTRODUCTION

In order to select an appropriate technique for the evaluation of exhaust system performance, the specific goals of the evaluation must be determined. The needs of the development engineer are quite different than those of the non-technical consumer. This paper will attempt to present the various considerations present in making such a selection and to illustrate a wide variety of available techniques.

There are essentially no "good" or "bad" mufflers. A given muffler may produce good noise control results on a given system or application while producing poor results for another. In addition, many secondary parameters must be included in order to fully characterize the performance of a given muffler. A summary of some basic design considerations is given in Fig. 1. Thus, to obtain an accurate statement of the muffler's performance, it is necessary to specify the precise exhaust system configuration and engine application including operating conditions such as speed and load.

Two of the primary acoustic considerations are whether to measure sound pressure or sound power and whether to use the actual level produced or the difference between the silenced and unsilenced levels. A "difference approach" has the advantage of relating more directly to the muffler performance independent of the noise source involved, while a "level approach" has the advantage of relating more directly to the sound perceived by the listener and associated loudness.

The choice between sound pressure and sound power is essentially a choice between a "point measurement" versus an "area measurement". Each approach has certain advantages. Sound pressure level must be given for a specified location and is most appropriate when such a location may be clearly determined. Sound power level is determined from a measurement of the average sound pressure level over area and, thus, may be more appropriate when the location of persons near the exhaust system is not clearly determined. Some of the practical considerations in making these measurements will be presented later.

I. EVALUATION TECHNIQUES

A flow chart of some of the major evaluation techniques that are available is shown in Fig. 2. Analytical and experimental approaches are listed and will be discussed in more detail in the following sections. The complexity of an actual engine exhaust system makes the selection of a single technique difficult. Severe temperature gradients, rapidly varying turbulent flow, high amplitude pressure variations and non-linear effects are among the primary factors contributing to this complexity. For this reason, most actual exhaust system engineering uses a combination of techniques to assist the exhaust system designer in obtaining optimum performance.

A wide variety of parameters are available for use by the designer in specifying the exhaust system performance (1-3). Some of these are listed in Fig. 3. In general, transmission loss is preferred for theoretical calculations because it does not depend on the engine source impedance. The determination of engine source impedance is a difficult problem that has received only limited study. For experimental work, insertion loss and noise reduction have come to be preferred because of their relative ease of determination.

The method of excitation used varies from the actual engine to a white noise source. While white noise has been recommended in the past as a solution to the problem of measuring the performance of highly tuned mufflers (4), in fact, this can be inadequate. A white noise source can produce conservative or optimistic predictions of a muffler's performance depending on the specific source, exhaust system, and measurement procedure used. Shock wave excitation has received considerable past study and has specific advantages in evaluating exhaust systems used on high-performance engines.(5,6)

II. ANALYTICAL TECHNIQUES

Analytical techniques offer the advantage of not requiring the time or cost of experimental procedures. They can range from simple parametric analysis techniques such as the use of muffler volume, as shown in Figs. 4 and 5, to complex acoustic models. (7-9) In general, the parameter technique is quite crude in comparison to acoustic modelling although very simple to apply.

The acoustic model developed and used at Nelson includes the effects of elevated temperatures, temperature gradients, mean flow, termination impedance, source impedance, higher order modes, and a wide variety of silencing configurations or elements. Derived from work by Alfredson and Davies (10-13), this model has been considerably improved and extended at Nelson to be applicable in a wider variety of cases. Although useful from a design standpoint, quantitative agreement with actual engine measurement is undergoing continued study in order to obtain improved correlation. Typical results are shown in Fig. 6. The predicted transmission loss plot shows major minima at about 425 Hz, 850 Hz and so on corresponding to the length of the expansion chamber equalling a multiple of a half wavelength. Additional secondary minima are present at about 150 Hz, 300 Hz and so on corresponding to the length of the tailpipe equalling a multiple of a half wavelength. The predicted insertion loss plot illustrates somewhat increased complexity, partially due to the effect of the exhaust pipe. Neither plot is in good quantitative agreement with the engine measured insertion loss,

although the frequency characteristics show some qualitative agreement and the amplitudes reflect some general trends. Even with these limitations, this computer model has been successfully utilized in a number of commercial design activities.

III. EXPERIMENTAL TECHNIQUES

Experimental techniques fall into the two general categories of closed and open system techniques. A variety of these techniques are illustrated in Fig. 7. Closed system measurements do not include the radiation from the walls of the muffler shell or exhaust system piping. The most common example of such a system is the impedance tube. (14-16) Typically used to measure transmission loss using a pure tone source and anechoic termination, this device can also be used with a white noise source. Very similar results are obtained in considerably less time. Results from such measurements are illustrated in Fig. 8 along with results from the Nelson analytical model. The agreement between the top two curves is very good and typical of the results obtained using this technique with the pure tone or white noise source. In this example, the solid extended inlet and outlet of the pass muffler are approximately equal to half the length of the muffler resulting in the peaks at about 300 Hz, 900 Hz and so on. Measurements may also be made using taped engine noise and other terminations as will be shown later.

The closed impedance tube may also be used in the time domain as a "pulse tube". This technique, which has received considerable development at Nelson, offers the advantage of presenting the pressure waveform as perceived by the listener and as associated with the engine in the time domain. Results will be shown below.

Open system measurements include the noise radiated from muffler and tailpipe walls by terminating the impedance tube in an open space such as a semi-anechoic or reverberant chamber. The excitation may be typically an electronic noise

source, blower, standardized engine, or actual engine. At Nelson, two semi-anechoic chambers and a reverberant chamber are available for use in such measurements as shown in Figs. 9 and 10. (17) The semi-anechoic chamber is the most widely utilized sound chamber for muffler evaluation. Its primary advantage is its correlation without the associated weather problems with measurements made outdoors on actual equipment. The reverberant chamber allows measurement of the spatially averaged sound pressure level from which the sound power level may be readily calculated. For applications in which the desired point of measurement is not readily apparent, the reverberant room measurement provides a potential advantage in that the average value is obtained. However, if the measurement in the semi-anechoic chamber is simply made at the angle of maximum sound pressure level, this advantage is minimized since the spatial average will be strongly dominated by this maximum value. Thus, for muffler work, the main advantages of the reverberant chamber become its lack of anechoic wedges allowing greater flexibility in exhaust system piping and a decrease in installation and maintenance expense.

IV. COMPARISON OF TECHNIQUES

A. BASIC SILENCING ELEMENT

The performance of a basic expansion chamber silencing element was evaluated using a variety of the above techniques. In Fig. 11, results using the analytical model with an anechoic termination and free-field termination are compared to results measured on the impedance tube developed at Nelson. The expansion chamber and tailpipe effects as well as the higher order mode effects (at about 2800 Hz) are predicted with fair accuracy, especially for the anechoic termination case, by the analytical model.

In Fig. 12, results for the same unit using the analytical model with an anechoic termination, tailpipe, and tailpipe/exhaust pipe combination including source impedance effects to obtain insertion loss are compared to results measured.

on an actual engine. The qualitative agreement is fair, but the amplitude and details of the frequency dependance again show considerable lack of quantitative correlation. Many of the same features mentioned in Fig. 11 are again evident.

In Fig. 13, results for the same unit using various arrangements of the impedance tube are compared to results measured on an actual engine. Agreement of the simulated tests with the analytical results in Fig. 12 is fairly good, but agreement with the engine results is again less than desired even with proper correction for the higher exhaust gas temperatures.

In addition to the transmission loss and insertion loss measurements illustrated above, transfer function measurements may also be made as shown in Fig. 14 along with the associated coherence. (18) The inversion of the transfer function plot produces a curve proportional to the transmission loss plots presented earlier. The minima and maxima agree quite well with the values expected from analytical considerations for this pass muffler.

While frequency domain analysis is most commonly used in muffler analysis, time domain analysis using the pulse tube approach described above can provide a useful alternative. At Nelson a pulse tube has been developed for this purpose. Results of such a measurement are shown in Fig. 15 for a variety of expansion chambers. The transmitted pressure pulses show good agreement with the analytically expected values of amplitude and timing. Specifically, the time between output pulses may be calculated to be about 2 msec corresponding to a round trip distance of about 2 feet or twice the chamber length.

B. INDUSTRIAL MUFFLER

The performance of a typical industrial muffler was evaluated using white noise excitation with the impedance tube and the intake and exhaust noise from an actual engine as shown in Fig. 16. (19) The lack of agreement of the insertion loss measured on the intake to the impedance tube results is increased by flow generated noise in the intake system. The lack of agreement of the insertion loss measured on the exhaust to the impedance tube results is increased by

interference effects due to floor reflections. The overall A-weighted sound levels were reduced from 117 dBA to 99 dBA for the white noise source, from 100 dBA to 83 dBA for the intake noise and from 119 dBA to 91 dBA for the exhaust noise.

C. TRUCK MUFFLER

The performance of a typical truck muffler was evaluated using white noise excitation with the impedance tube and the exhaust noise from an actual engine as shown in Fig. 17. The lack of detailed correlation is again readily noted. The overall A-weighted sound levels were reduced from 115 dBA to 78 dBA for the white noise source and from 111 dBA to 72 dBA for the engine noise.

Other detailed studies at Nelson have demonstrated the dependence of exhaust noise on exhaust system configuration as shown in Fig. 18. (20) The overall A-weighted sound level can be seen to vary as much as 7 dB for the same muffler. This again emphasizes the importance of specifying the application for a given muffler. In addition, the directivity pattern from an exhaust outlet can be an important variable as shown in Fig. 19. The shape of the spectra varies considerably as a function of angle from the outlet. As discussed previously, in a semi-anechoic chamber, the measurement location must be carefully selected, usually on the basis of maximum sound pressure level. In a reverberant chamber, this problem is avoided by obtaining a spatial average of the sound pressure level. Of course, directivity information is lost in such a sound power measurement.

V. SUMMARY

The selection of an evaluation technique must be based on the specific goals of the evaluation procedure. In Fig. 20, the major techniques described above have been ranked according to the primary characteristics of accuracy and cost. It is clear that many tradeoffs must be considered before a given technique can be selected. Although various approaches can be useful mainly for design

purposes; final muffler evaluation usually demands an actual engine test. Only in this way can the required accuracy be achieved (21). Errors of 5-10 dB in muffler performance prediction, often encountered in other techniques, are not acceptable for today's application problems.

ACKNOWLEDGEMENTS

The assistance of Dr. Ivan Morse of the University of Cincinnati in providing the transfer function measurements and D. Olson, D. Flanders, R. Hoops, and G. Goplen of Nelson in providing supplementary data is gratefully acknowledged.

REFERENCES

- 1) Don D. Davis, Jr., "Handbook of Noise Control", C. M. Harris, Jr. (ed). New York: McGraw-Hill, 1957, Chapter 21, p. 21-5.
- 2) T. F. W. Embleton, "Noise and Vibration Control", Leo L. Beranek, (ed.). New York: McGraw-Hill, 1971, Chapter 12, pp. 363-364.
- 3) Norman Doelling, "Noise Reduction", Leo L. Beranek, (ed.). New York: McGraw-Hill, 1960, Chapter 17, pp. 435-437.
- 4) Irwin J. Schumacher, Cecil R. Sparks, and Douglas J. Skinner, "A Bench Test Facility for Engine Muffler Evaluation." Paper 771A Presented at SAE National Powerplant Meeting, Chicago, October, 1963.
- 5) B. Sturtevant, "Investigation of Finite Amplitude Sound Waves", Presented at Interagency Symposium on University Research in Transportation Noise, March 28-30, 1973, Stanford, California.
- 6) B. Sturtevant, "Relationship Between Exhaust Noise and Power Output of Small High-Performance Internal Combustion Engines", Final Report to Nelson Industries, January, 1975.
- 7) L. J. Eriksson, "Exhaust Systems for High-Performance, Four-Stroke Engines." Presented at Noise-Con 73, Washington, October, 1973.
- 8) "Muffler Design Guide." Bulletin No. 74500, Nelson Muffler, Stoughton, Wisconsin.
- 9) Erich K. Bender and Anthony J. Brammer, "Internal Combustion Engine Intake and Exhaust System Noise", J. Acoust. Soc. Am. 58 (1) 22-30 (1975).
- 10) Robin J. Alfredson, "The Design and Optimization of Exhaust Silencers." Ph. D. Thesis, Inst. Sound and Vib. Res., Univ. of Southampton, July, 1970.
- 11) R. J. Alfredson and P. O. A. L. Davies, "Performance of Exhaust Silencer Components", J. Sound Vib. 15 (2), 175-190 (1971).
- 12) Tony L. Parrott, "An Improved Method for Design of Expansion-Chamber Mufflers with Application to an Operational Helicopter", NASA Technical Note TN D-7309, Washington, October, 1973.
- 13) John E. Sneckenberger, "Recent Results Toward Experimental and Analytical Predictions of Basic Engine Exhaust System Performance - Part II - Some Progress in Computer-Aided Design for Analysis and Optimization of Basic Exhaust Systems." Presented at the Eighth Annual Noise Control in Internal Combustion Engines Seminar, University of Wisconsin, Madison, January, 1970.

REFERENCES (Cont.)

- 14) Don D. Davis, Jr., et. al., "Theoretical and Experimental Investigation of Mufflers with Comments on Engine Exhaust Muffler Design." NACA Report 1192, (1954).
- 15) Don D. Davis, Jr., "Handbook of Noise Control", C. H. Harris, Jr. (ed.). New York: McGraw-Hill, 1957, Chapter 21, p. 21-43.
- 16) D. C. Flanders, "Recent Results Toward Experimental and Analytical Predictions of Basic Engine Exhaust System Performance - Part I - Impedance Tube: A Tool for the Research and Development of Basic Muffler Elements." Presented at the Eighth Annual Noise Control in Internal Combustion Engines Seminar, University of Wisconsin, Madison, January, 1976.
- 17) L. J. Eriksson, "Innovative Approaches to Engine Noise Measurement." Presented at the Eighth Annual Noise Control in Internal Combustion Engines Seminar, University of Wisconsin, Madison, January, 1976.
- 18) Data provided by Dr. Ivan Morse, University of Cincinnati, Cincinnati, Ohio.
- 19) D. A. Olson, D. C. Flanders, and L. J. Eriksson, "An Integrated Approach to Exhaust and Intake Noise." Paper 760602 presented at SAE West Coast Meeting, San Francisco, August, 1976 and SAE Off-Highway Meeting, Milwaukee, September, 1976.
- 20) D. A. Olson, K. D. Nordlie, and E. J. Seils, "Techniques and Problems of Truck Exhaust System Noise Measurement." Paper 770895 presented at SAE Truck Meeting, Cleveland, October, 1977.
- 21) L. J. Eriksson, "Discussion of Proposed SAE Recommended Practice XJ1207, Measurement Procedure for Determination of Silencer Effectiveness in Reducing Engine Intake on Exhaust Sound Level", Presented at U.S.E.P.A. Surface Transportation Exhaust Noise Symposium, Chicago, October, 1977.

NOTATION FOR FIGURES

A_n	Incident pressure amplitude
B_n	Reflected pressure amplitude
Z	Impedance
Q	Directivity factor
A	Room constant
R	Measurement distance
M	Muffler volume
D	Engine displacement
IL	Insertion loss (L_{IL})
TL	Transmission loss (L_{TL})
5.6X24	5.6 inch diameter, 24 inch long muffler
65 tailpipe	65 inch long tailpipe
18 exhaust pipe	18 inch long exhaust pipe
F/S	feet per second
70F	70 degree Fahrenheit average exhaust gas temperature
DB	Unit for sound pressure level in decibels
DBA	Unit for A-weighted sound level in decibels
3600 RPM	3600 RPM engine speed

FIGURE CAPTIONS

- Figure 1 - Summary of Basic Design Considerations
- Figure 2 - Flow Chart of Major Evaluation Techniques
- Figure 3 - Exhaust System Schematic and Evaluation Parameters
- Figure 4 - Insertion Loss Versus Muffler Volume to Engine Displacement Ratio for a Wide Variety of Applications
- Figure 5 - Design Guide Derived from Data Such as That Shown in Fig. 4
- Figure 6 - Transmission Loss and Insertion Loss from Nelson Analytical Model Compared to Insertion Loss Measured on a Single Cylinder, Four Stroke Engine Under Full Load at 3600 RPM
- Figure 7 - Summary of Experimental Techniques
- Figure 8 - Typical Results from Impedance Tube Insertion Loss Measurements Using White Noise Excitation and Transmission Loss Measurements Using Sine Wave Excitation Compared to Analytical Results
- Figure 9 - Nelson Large Reverberant Chamber and Semi-Anechoic Chamber
- Figure 10- Outaway View of Nelson Large Engine Test Facilities
- Figure 11- Comparison of Analytical to Experimental Results Using Impedance Tube and Floor Mounted Microphone
- Figure 12- Comparison of Analytical to Experimental Results Using Single Cylinder, Four Stroke Engine Under Full Load at 3600 RPM With Floor Mounted Microphone
- Figure 13- Comparison of Impedance Tube to Engine Run Results Using Single Cylinder, Four Stroke Engine Under Full Load at 3600 RPM With Floor Mounted Microphone
- Figure 14- Transfer Function and Coherence Measurements for Simple Pass Muffler With 4.5 Inch Solid Extended Inlet and Outlet Tubes Prior to Perforations
- Figure 15- Time Domain Evaluations of Expansion Chambers Using Single Pulse Excitation
- Figure 16- Comparison of Insertion Loss on Typical Industrial Muffler Using Three Different Sources (Microphone at 30 Inch Height for Intake Measurements and 24 Inch Height for Exhaust Measurements)
- Figure 17- Comparison of Impedance Tube to Engine Results With Microphone 50 Feet From Outlet and Four Feet High

FIGURE CAPTIONS (Cont.)

Figure 18 - Effect of Varying Tailpipe and Exhaust Pipe Length on Large Engine Exhaust Noise

Figure 19 - Effect of Measurement Position on Exhaust Noise From Single Cylinder, Four Stroke Engine Under Full Load at 3600 RPM

Figure 20 - Major Techniques Ranked According to Accuracy and Cost

MINIMUM NOISE LEVEL

MAXIMUM ENGINE PERFORMANCE

MINIMUM WEIGHT

MINIMUM SIZE

MINIMUM COST

LONG LIFE

GOOD TONAL QUALITY

EASY TO MANUFACTURE

CONVENIENT SHAPE

MINIMUM TEMPERATURE

ATTRACTIVE APPEARANCE

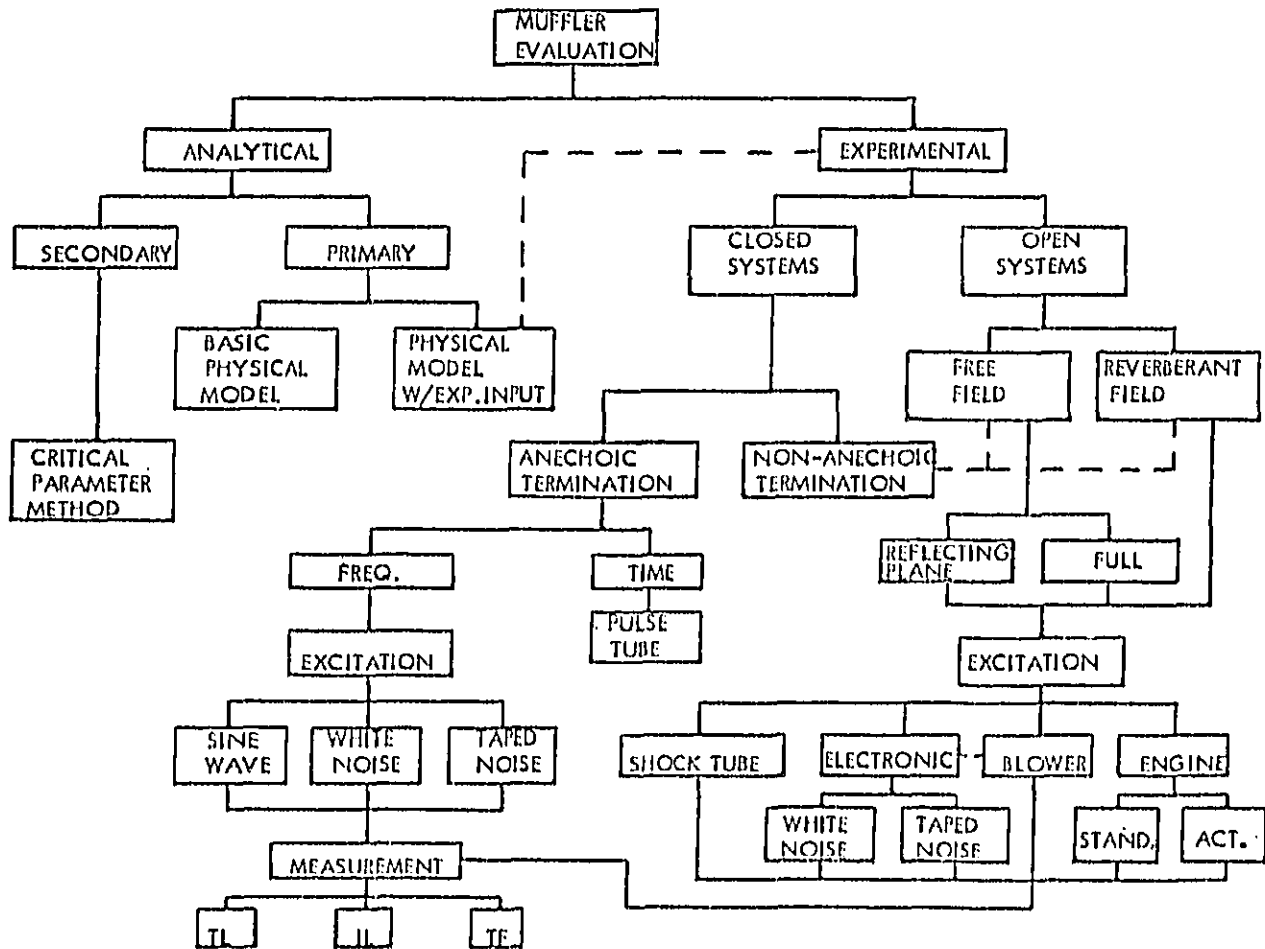
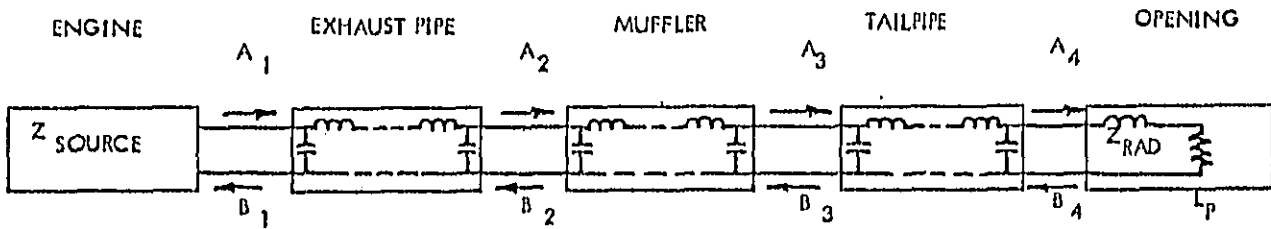

FIGURE 2



$$L_p = L_w + 10 \log \left[\frac{Q}{4\pi R^2} + \frac{4}{A} \right] + 10 \quad (R^2, A \text{ IN FEET}^2, L_w \text{ RE } 10^{-12} \text{ W.})$$

$$L_{TL} = 10 \log \left[\frac{|A_2|^2 Z_3}{|A_3|^2 Z_2} \right]$$

$$L_{TL} = L_p \text{ (WITHOUT MUFFLER)} - L_p \text{ (WITH MUFFLER)}$$

$$NR = L_p \text{ (INPUT)} - L_p \text{ (OUTPUT)}$$

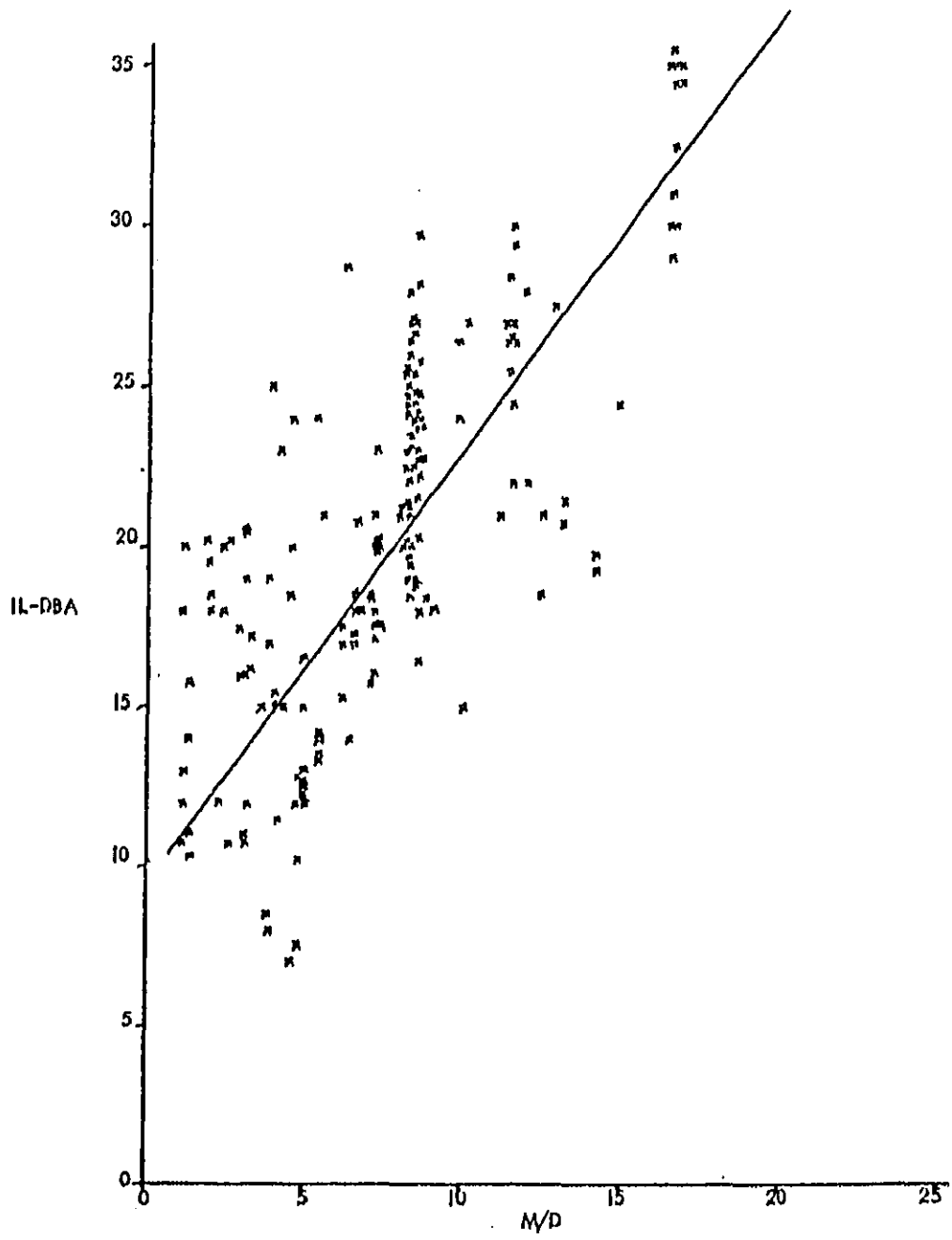

Figure 4

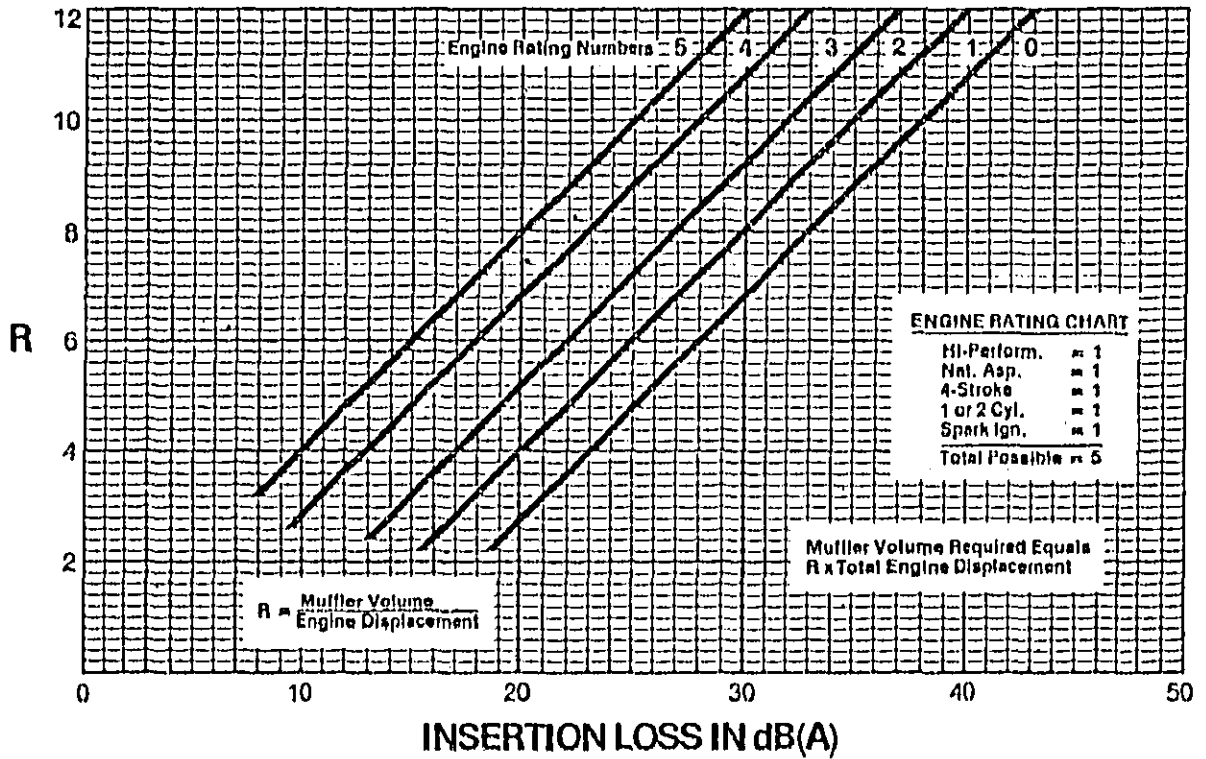

Figure 5

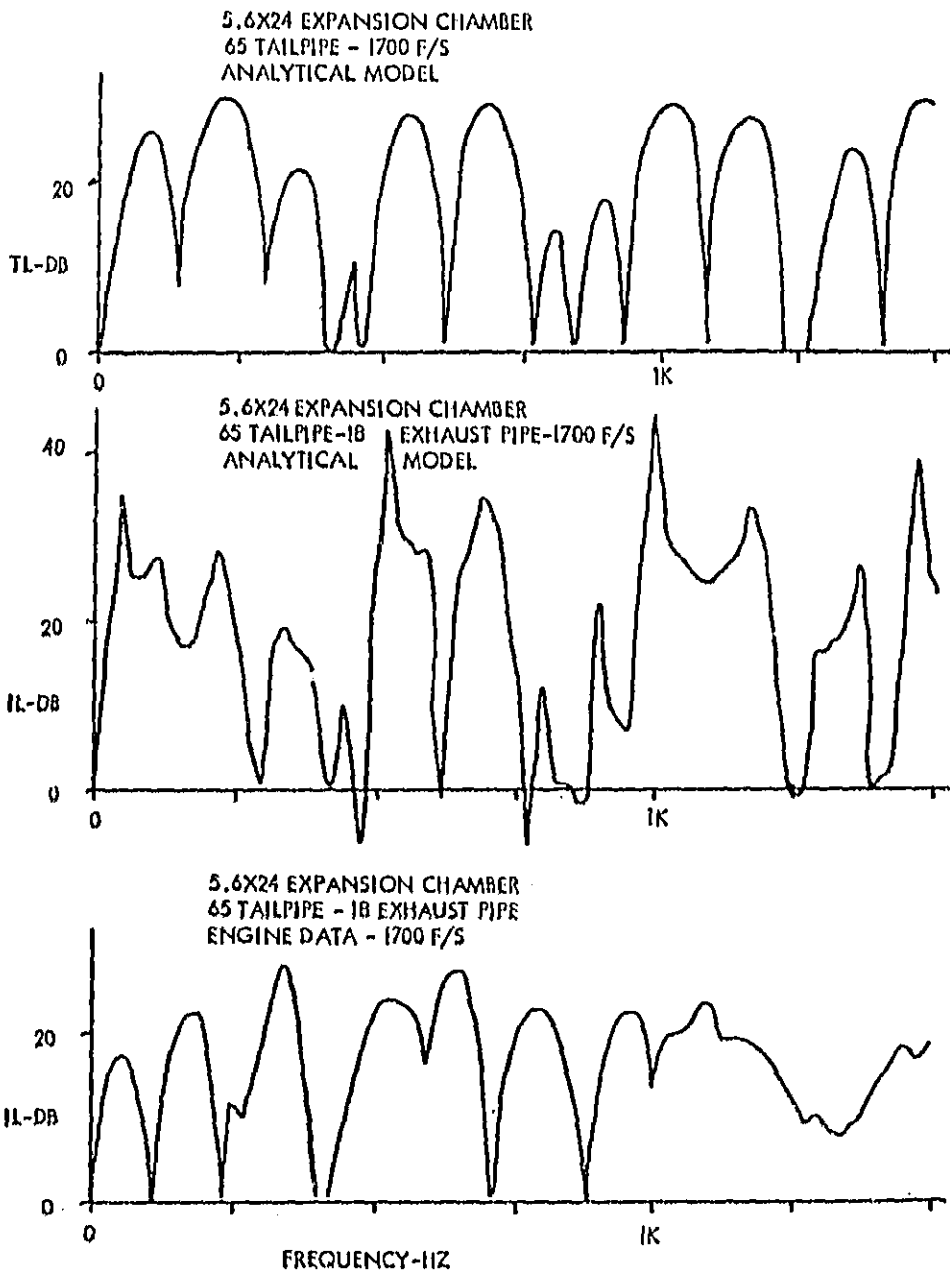

Figure 8

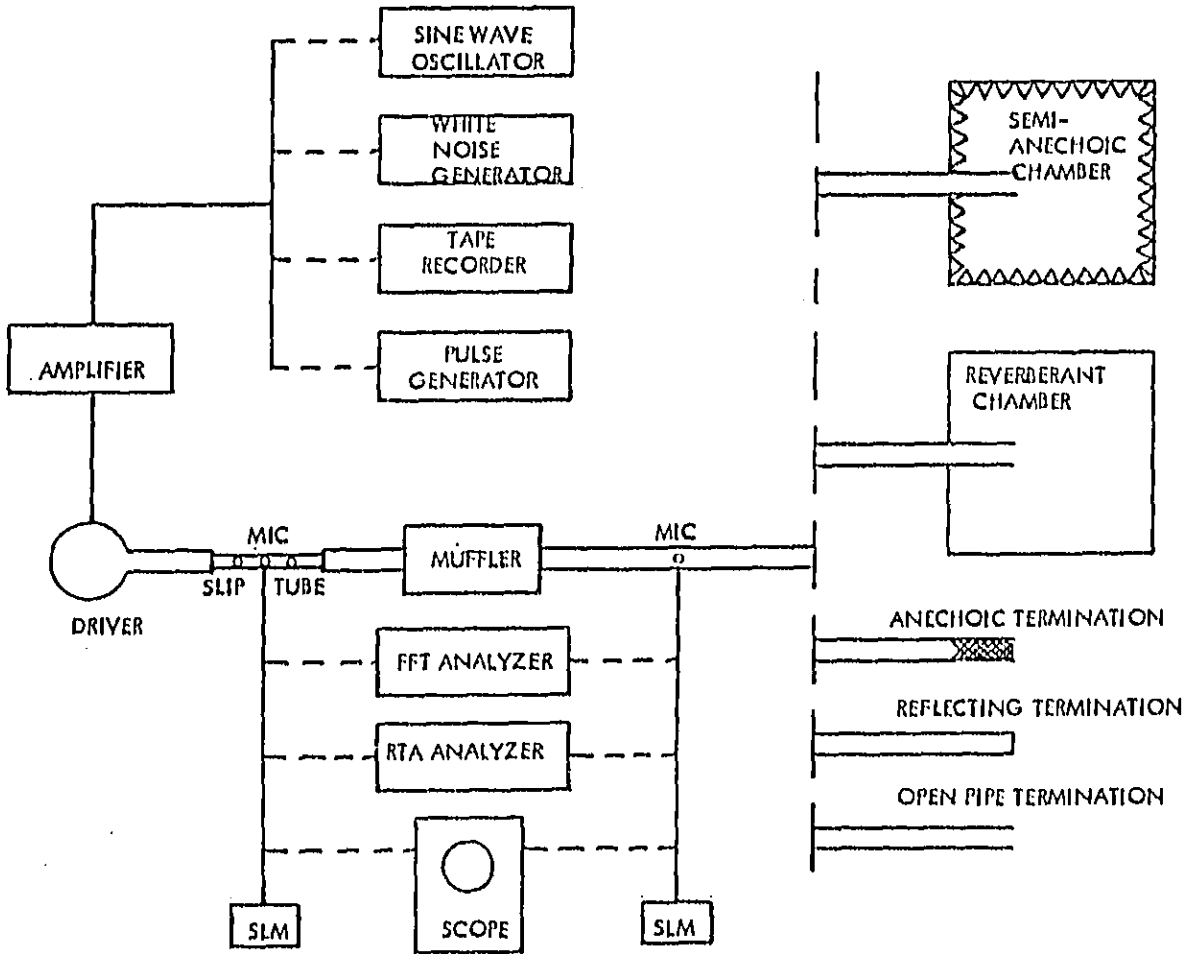
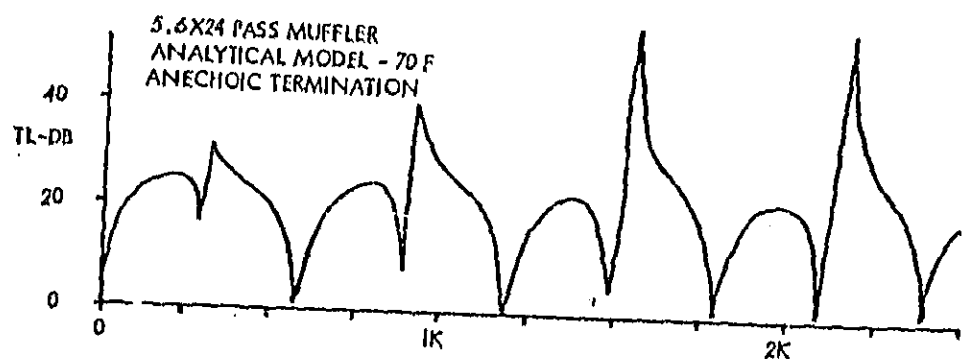
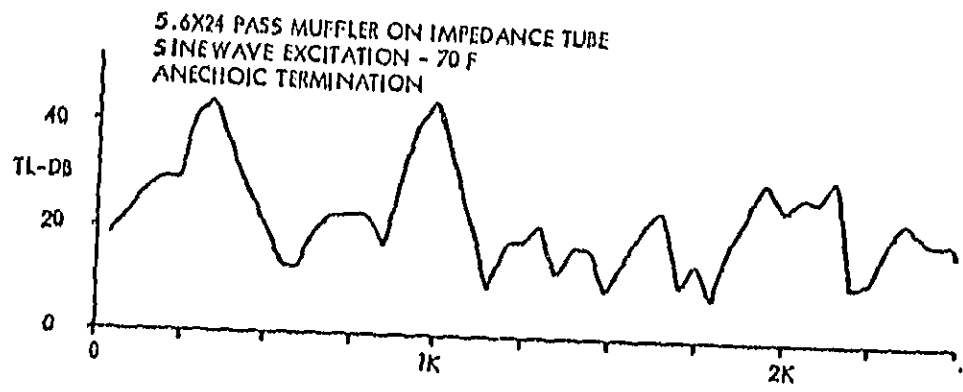
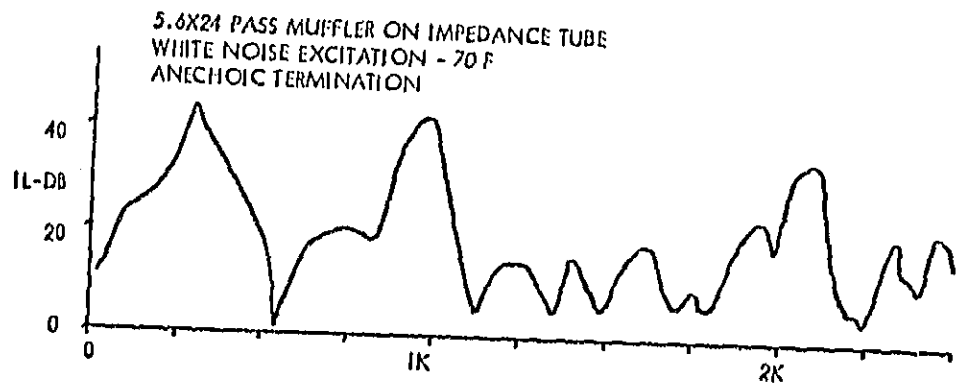

Figure 7



FREQUENCY-HZ
 254

Figure 8

DEPT AVIAR 308 E 200000

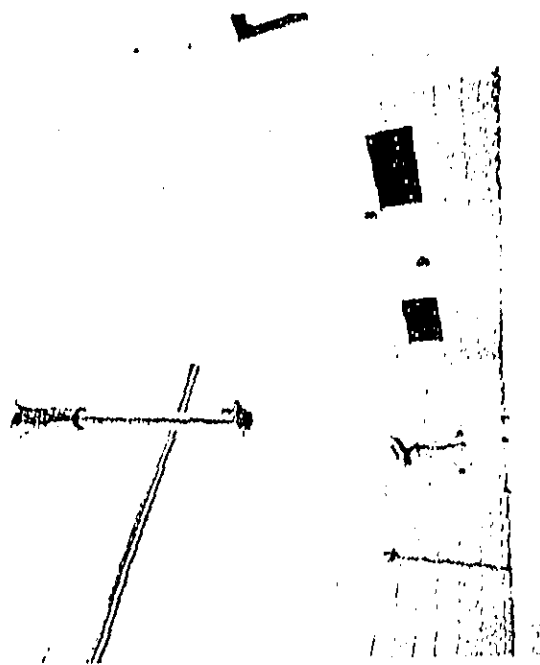
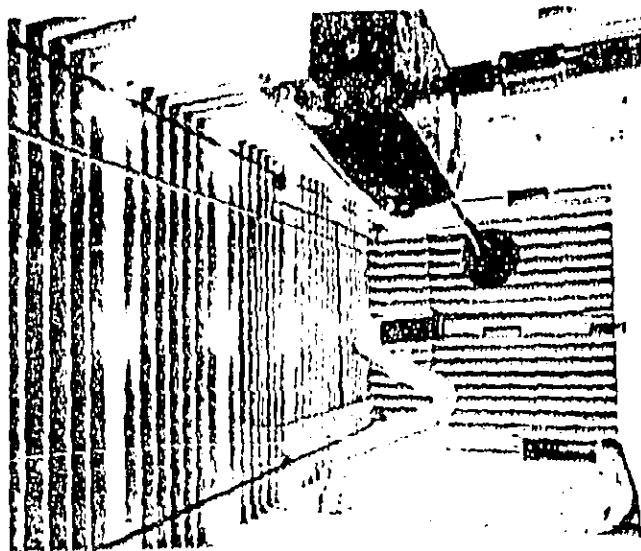
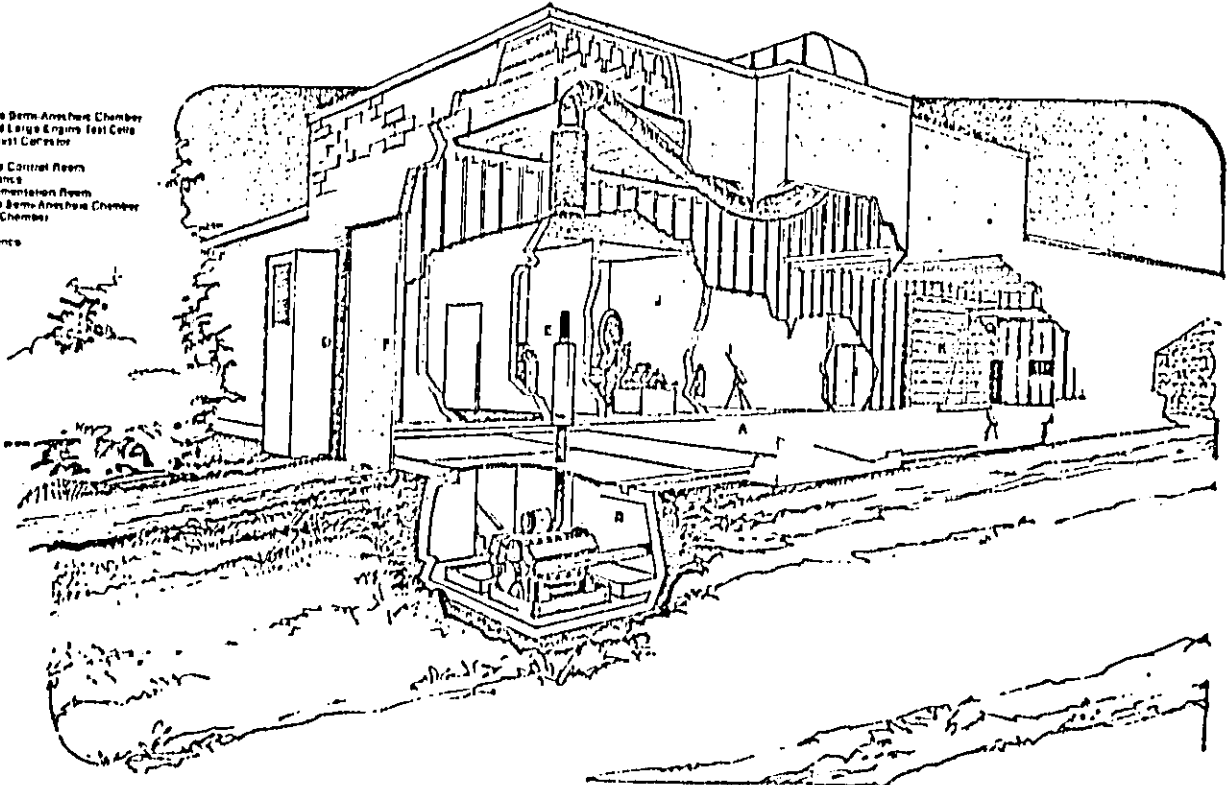

Figure 9

Cutaway View of Technical Center

- A. Large Engine Bern-Anoxia Chamber
- B. Underground Large Engine Test Cells
- C. Engine Exhaust Collector
- D. Air Intake
- E. Large Engine Control Room
- F. Vehicle Entrance
- G. Sound Instrumentation Room
- H. Small Engine Bern-Anoxia Chamber
- I. Prevalent Chamber
- J. Dyno Cells
- K. Vehicle Entrance



256

Figure 10

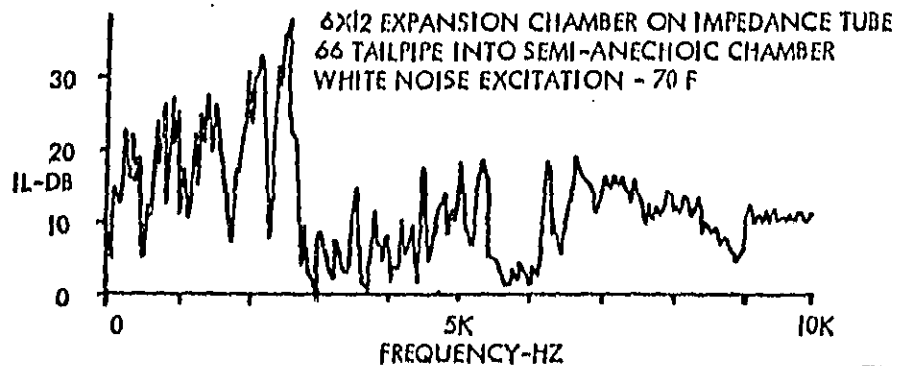
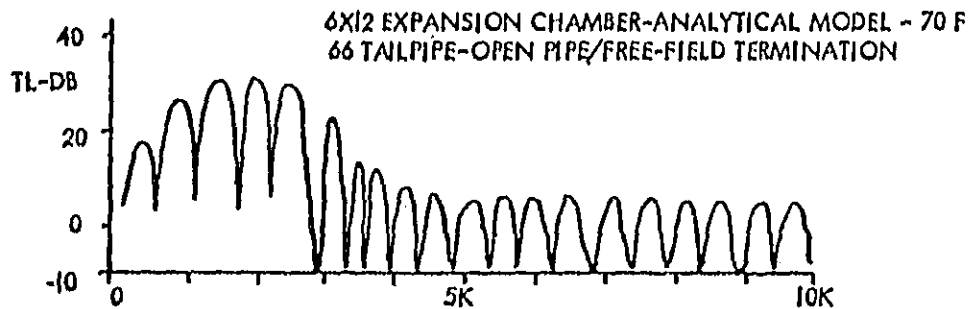
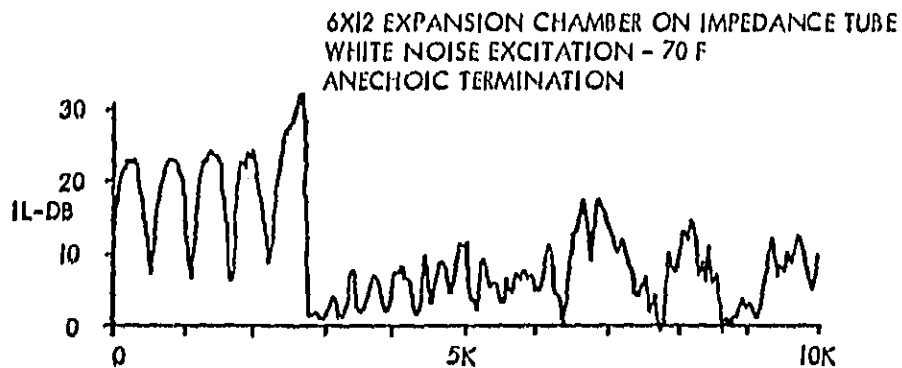
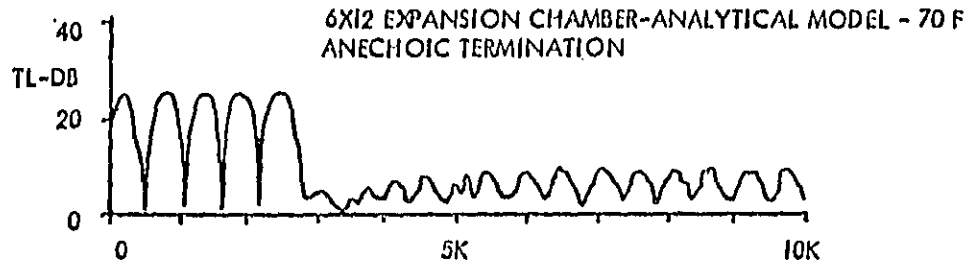

Figure 11

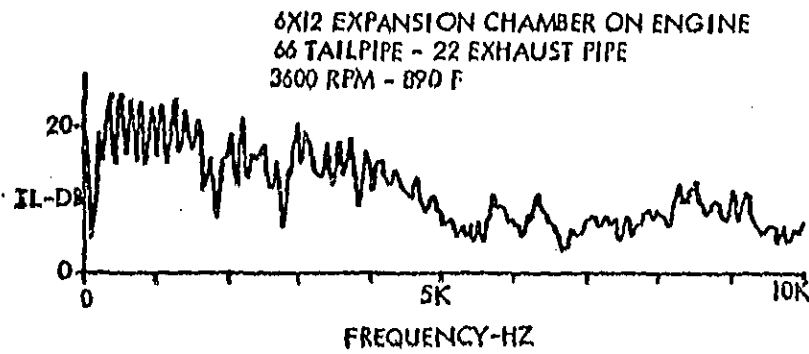
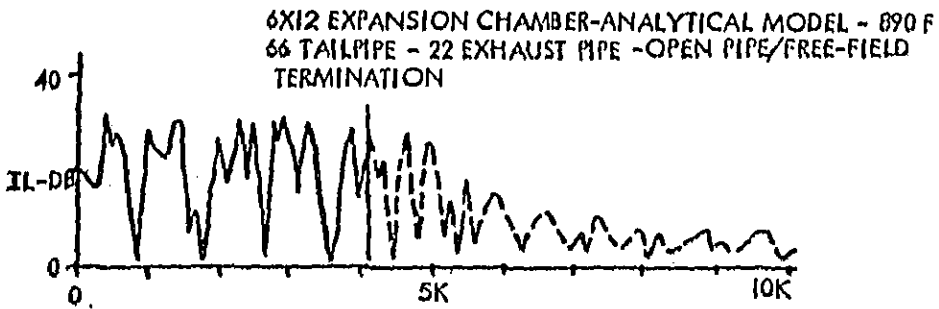
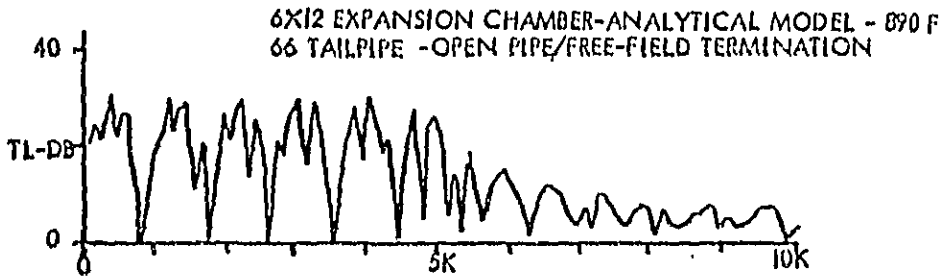
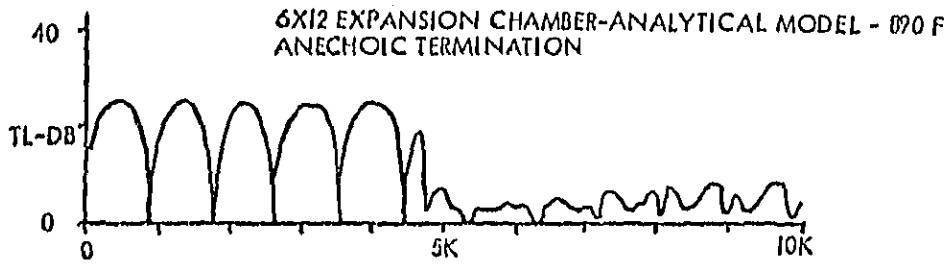

Figure 12

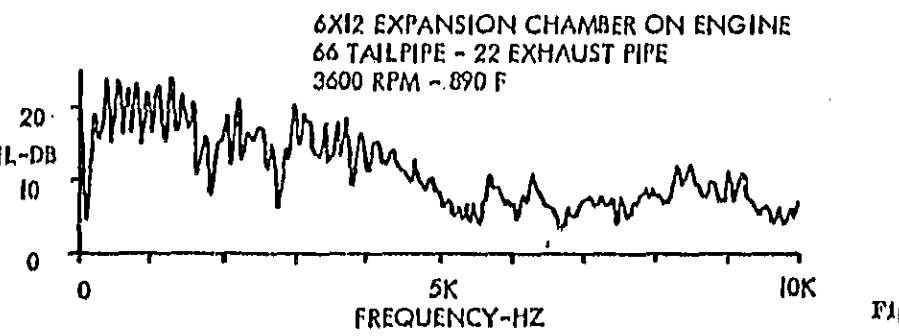
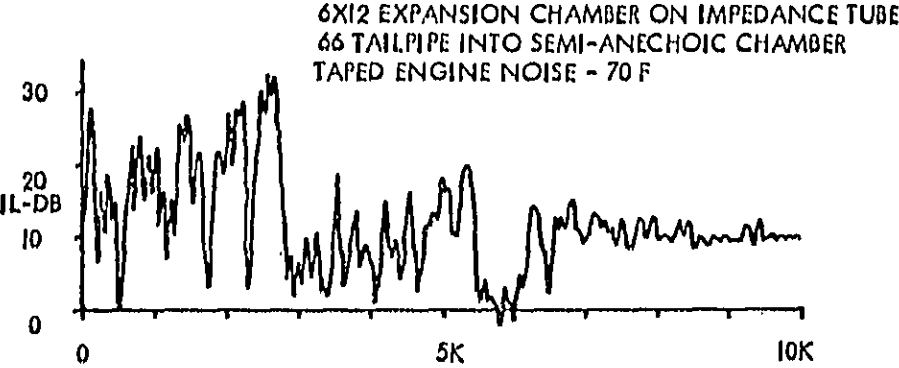
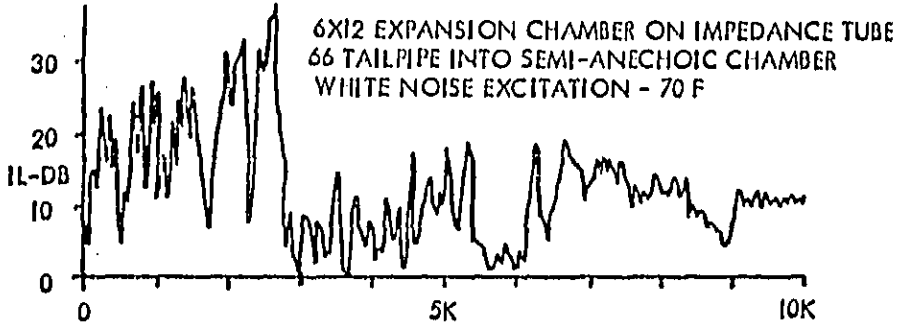
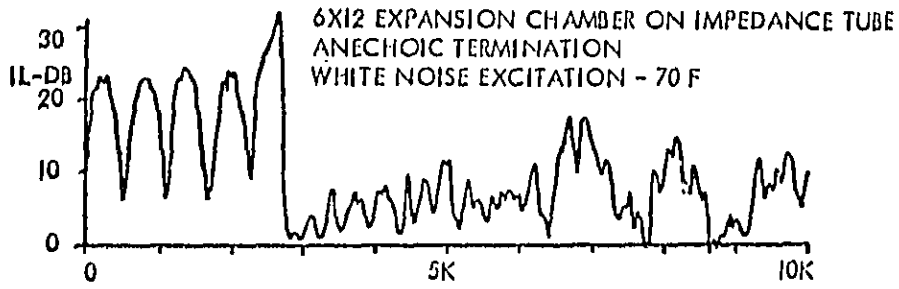

Figure 13

REF ID: A611 481 5 0087

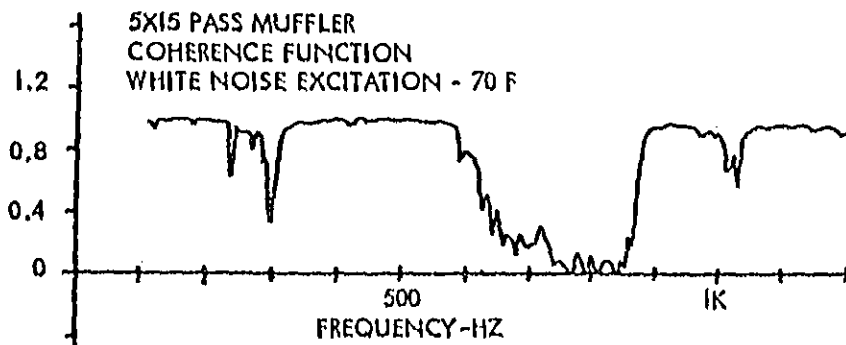
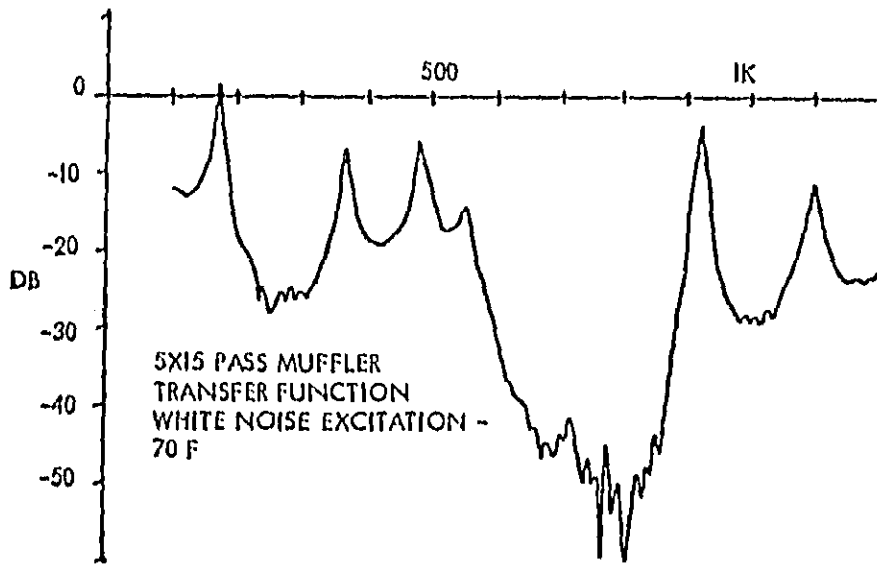

Figure 14

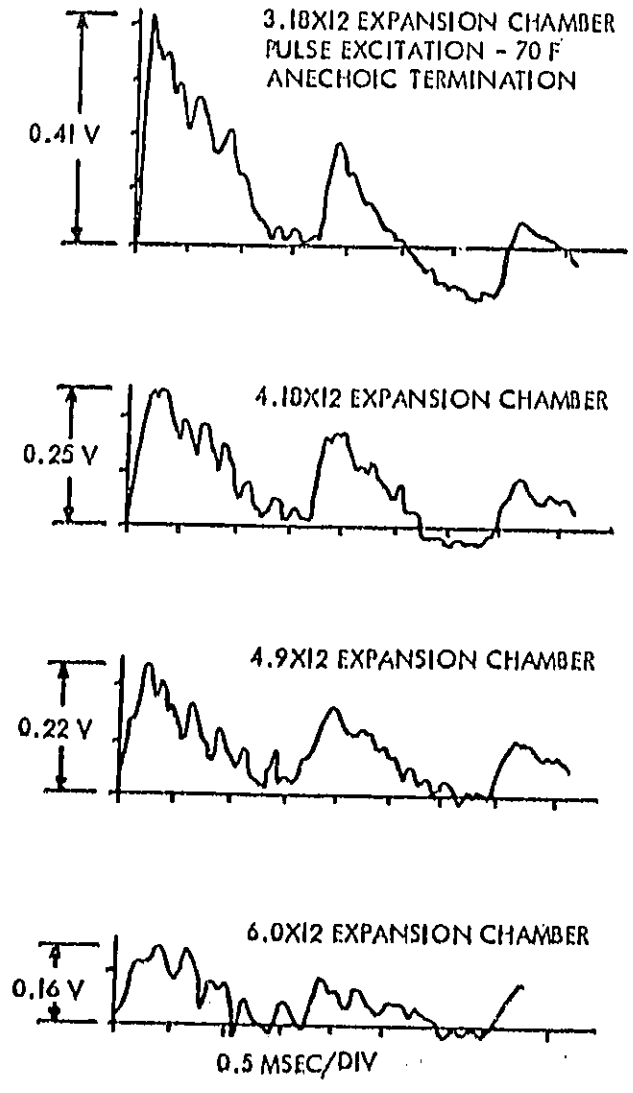
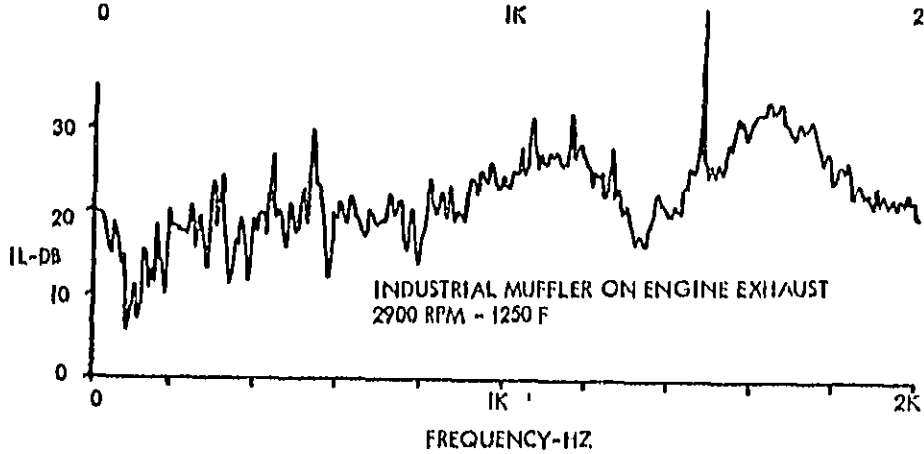
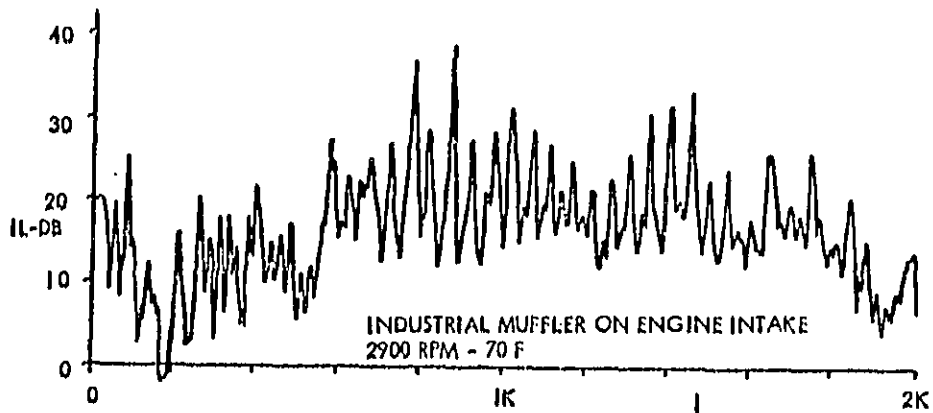
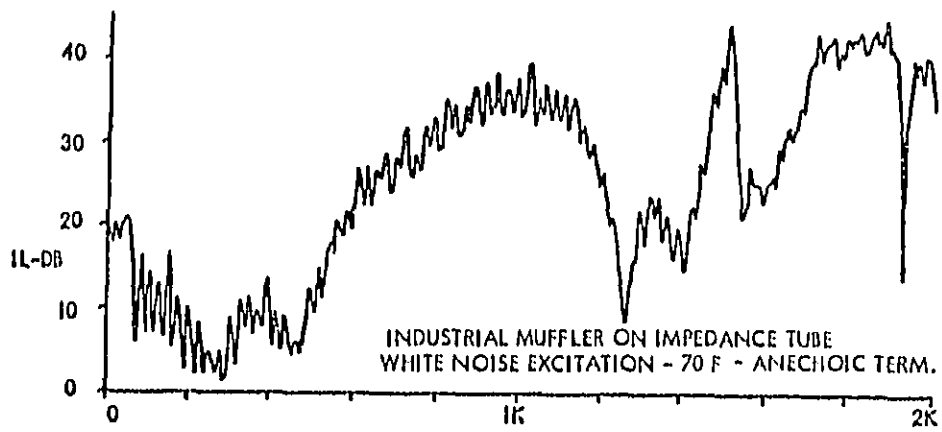

Figure 15

RECT AVIATION SYSTEMS



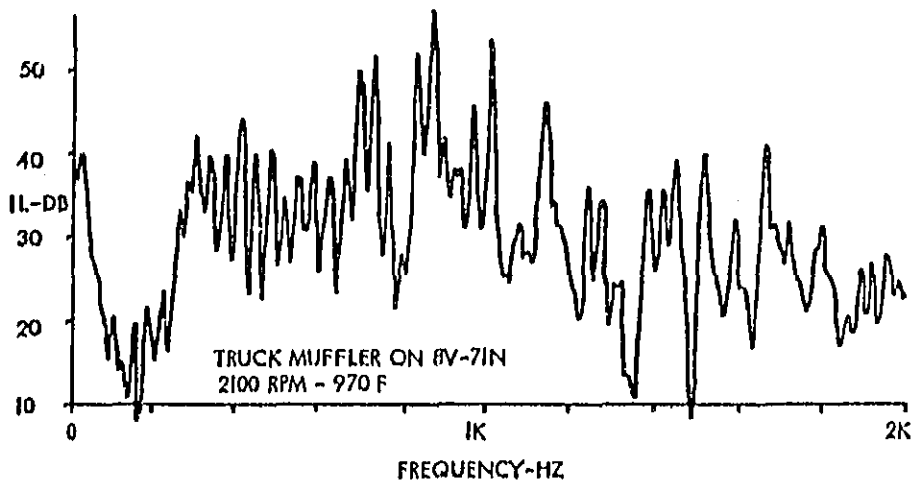
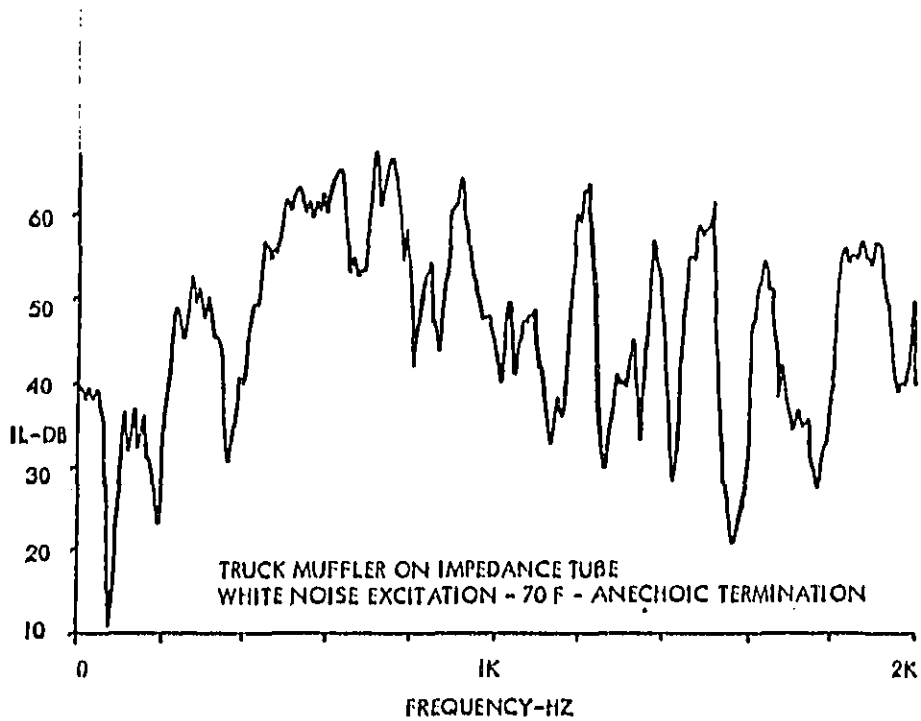
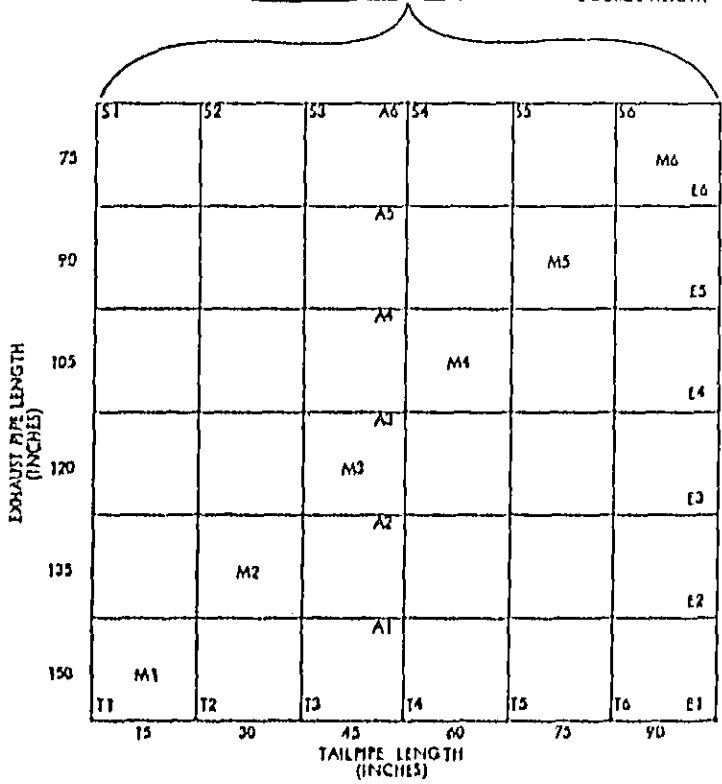
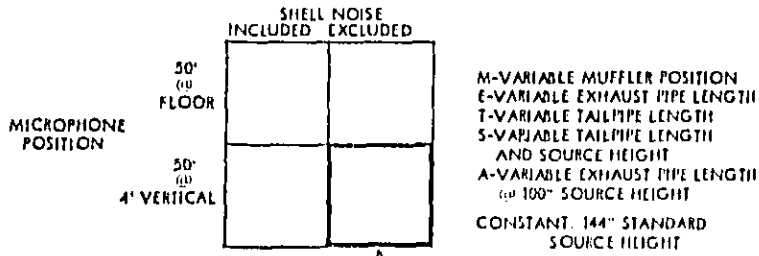

Figure 17



	M	E	T	S	A
1	76.5	74.5	76.5	76.5	75.0
2	71.0	72.0	74.0	74.5	72.5
3	71.5	71.5	76.0	73.5	71.5
4	73.5	71.5	77.0	73.5	72.0
5		73.0	78.0	74.0	72.5
6	72.5	72.5	74.5	72.5	73.5

dBA

50' (0) 4' VERTICAL
SHELL NOISE INCLUDED

	M	E	T	S	A
1	72.5	70.5	72.5	75.0	70.5
2	68.5	68.5	71.5	70.0	68.5
3	67.5	67.5	70.5	70.5	67.5
4	68.5	67.0	72.5	71.0	68.5
5		69.0	73.5	71.5	69.0
6	69.5	69.5	70.5	69.5	70.5

dBA

50' (0) 4' VERTICAL
SHELL NOISE EXCLUDED

264

Figure 18

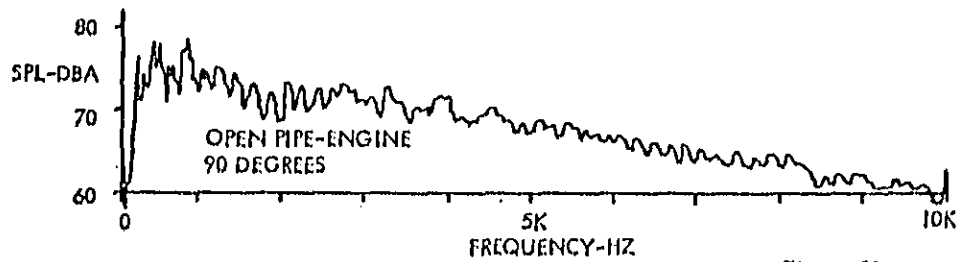
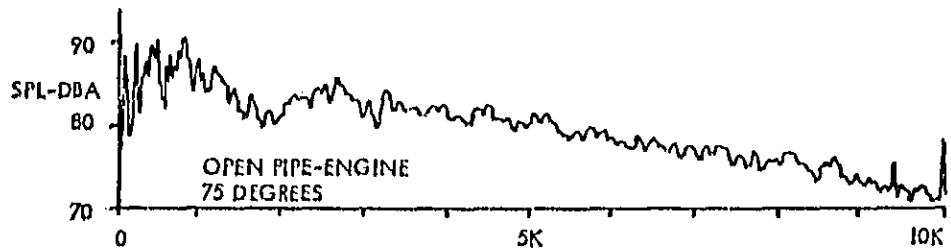
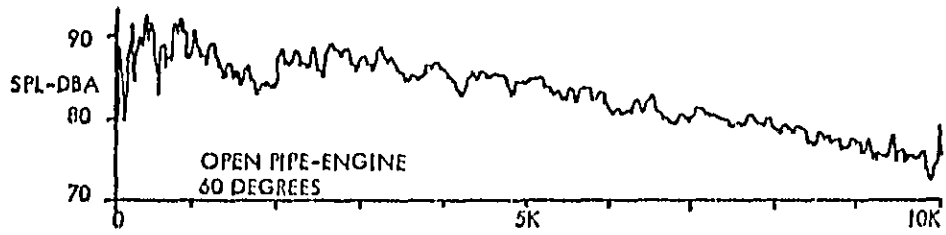
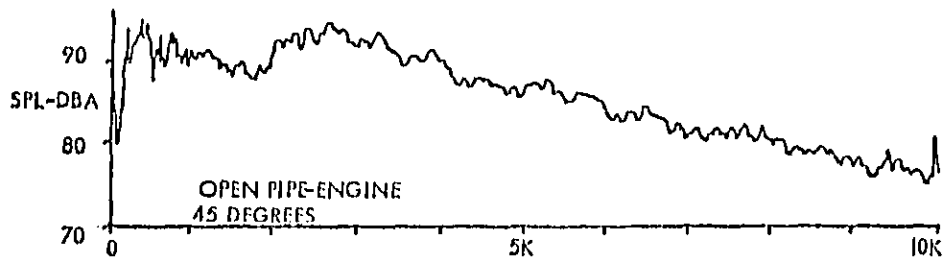
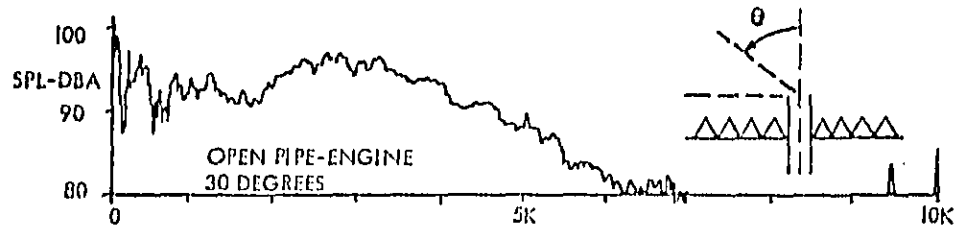

Figure 19

COMPARISON OF EVALUATION METHODS

MOST ACCURATE?

- 1) ACTUAL ENGINE
- 2) STANDARD ENGINE
- 3) SIMULATED SOURCE
- 4) ANALYTICAL MODEL
- 5) PARAMETER EVALUATION

LOWEST COST?

- 1) PARAMETER EVALUATION
- 2) SIMULATED SOURCE
- 3) ANALYTICAL MODEL
- 4) STANDARD ENGINE
- 5) ACTUAL ENGINE

Figure 20

A COMPUTER-AIDED APPROACH TOWARD PERFORMANCE PREDICTIONS
FOR ENGINE EXHAUST MUFFLER

John E. Sneckenburger
Associate Professor

West Virginia University
College of Engineering
Morgantown, WV 26506

presented at

U. S. Environmental Protection Agency
Surface Transportation Exhaust Noise Symposium

Chicago, IL

October 1977

organized by
McDonnell-Douglas Co.

INTRODUCTION

Engineering acoustics has been an area of study in the Mechanical Engineering and Mechanics Department at West Virginia University since 1971, with student involvement from freshman projects to graduate research. Somewhat of interest to some might be the fact that muffler design, development and testing is taught to freshman engineering students, and in only three weeks, during only one day each week, and only for three hours in the afternoons of these three days. Thus, because of student project grading requirements, I have been evaluating and 'labeling' mufflers - with a letter grade - for years. My 'regulatory policy' for muffler labeling must be a good one and maybe, quite humorously of course, should be considered by the Environmental Protection Agency because I have yet to be taken to court concerning my regulatory policy.

During the summer of 1975, I participated as one of two summer faculty research participants at Nelson Industries, Inc. of Stoughton, WI under a National Science Foundation grant to the Nelson Research Department. As Larry Eriksson, vice-president of research, and I formulated a work plan for the ten-week period that summer, it was decided to attempt to expand the existing computer-aided design capabilities at Nelson Industries. At that time, improved computer-aided design was visualized as being an important compliment to an on-going impedance tube muffler development study. Now, today at this symposium, after considerable success as an analytical development, design, evaluation and (potentially) optimization tool for the manufacture of mufflers, this "Computer-Aided Approach Toward Performance Prediction for Engine Exhaust Mufflers" is

REST AVIAN LINE COPY

being presented to exhibit the increased extent, possible merit, etc of this computer-aided methodology to predict and to communicate noise reduction characteristics of vehicle exhaust systems. My presentation here will be an extension of a paper (1) presented in January 1976 at the Eighth Annual Noise in Internal Combustion Engines Seminar based on the initial work completed at Nelson Industries the previous summer. Presentation of information contained in that paper entitled "Some Progress in Computer-Aided Design for Analysis and Optimization of Basic Exhaust Systems" will be followed by some comments on the state of the computer program as it exists today as well as on the judged applicability of the computer program to function as an analytical simulation technique toward usefulness as a 'bench-type' methodology in regulatory muffler labeling.

This 1976 seminar paper just mentioned began with a brief description of three of the more recent approaches which seemingly offered potential for continuing future progress toward effective computer-aided design of exhaust systems. Secondly, the paper then discussed extension features which were incorporated into a recent National Aeronautics and Space Administration prepared computer-aided muffler design program to provide improved capabilities for Nelson Industries to complement its on-going muffler development work utilizing impedance tube experimentation. Thirdly, the paper then provided an example of how this extended NASA computer program permitted a parametric study for an extended inlet-extended outlet muffler to produce generalized computer-aided muffler design curves. Finally, several potential additions to expand the design analysis and optimization capabilities of the extended computer program were identified. This material will be presented in the next four sections of this paper.

RECENT COMPUTER-AIDED MUFFLER DESIGN METHODS

Munjal (2) had recently proposed a revised transfer matrix method, utilizing a modification to a previously defined velocity ratio function, for the computer evaluation of insertion loss for exhaust mufflers with mean flow. Acoustic pressure and mass velocity were redefined considering the convective coupling between acoustic phenomena and incompressible mean flow. Transfer matrices for various basic muffler elements were derived. Unlike the case for zero mean flow where each of the transfer matrices corresponded to one of the three types of impedances, such a correspondence did not appear to be the case for non-zero mean flow. See Figure 1.

Work by Karnopp, et al., (3) on modeling engine exhaust mufflers in bond graph terms had been recently reported in connection with the computer prediction of power and noise for two-stroke engines with power tuned, silenced exhausts. From the equivalent bond graph model of a lumped muffler (See Figure 2), recursion formulas relating acoustic pressure and volume flow rate in terms of the volume of fluid stored by the compliance element and the momentum of the fluid of an inertial element were formulated. The associated finite element computer program was developed to handle the one-dimensional effects of nonlinear wave steepening, flow resistance and high mean flow. The conclusion, however, seemed to be that such a one-dimensional computer program could not accurately describe complicated muffler configurations in which three dimensional effects are important.

In a then recent paper, Young and Crocker (4) used variational methods to formulate a mathematical description of the acoustic field existing in a muffler. See Figure 3. Solution of this variational method formulation for the acoustic field was obtained by finite element methods. For this approx-

imate solution numerical method approach, the muffler is divided into a number of subregions of nodal elements. Nodal parameters descriptive of the variation of acoustic pressure at each node were then defined. The prediction of the desired muffler transmission loss was then made by forming the equivalent acoustic four-terminal transmission network for which the nodal parameters are used to determine the four-terminal constants. Future papers were then planned to show that when applied to mufflers with complicated shaped chambers for which plane wave theory predictions are not available, transmission loss predictions using this method are in good agreement with experiments.

EXTENSIONS TO NASA MUFFLER DESIGN COMPUTER PROGRAM

The above three relatively new methods of computer-aided muffler design, as well as other possible methods which were not mentioned, indeed projected prospects for more progress in the analysis and optimization of exhaust mufflers in the near future. However, for immediate short term (ten weeks) applicability with some potential for later extension, it seemed most appropriate at that time to develop computer-aided design capabilities using the most complete computer program available based on muffler modeling which used essentially linear wave equation theory. Figure 4 illustrates how the planned computer-aided design capability would be incorporated into the overall scheme of manufacturing mufflers from specifications.

Such a rather well developed computer-aided muffler design program as suggested above for reactive extended inlet-extended outlet expansion chamber mufflers had been made available by the NASA through Technical Note TN D-7309.

This computer program is largely based on the work of Alfredson and Davies (5). The key features of the NASA computer program are listed in Figure 5.

In order to appreciate the complexity of a typical commercial muffler relative to the existing capability of the NASA computer program, Figure 6(a) shows a drawing of a two tube-three pass muffler taken from page 31-17 of the Handbook of Noise Control, Harris, ed.. As the projected and unfolded version of this muffler shown in Figure 6(b) illustrates, several features, such as multiported chambers and perforated tubes, are not readily handled by the existing NASA computer program.

As an initial effort to extend the NASA computer program, the program was converted from 'complete chamber' analysis to 'individual section' analysis. Further, efforts were directed at providing sectional models for plug and two-pass muffler sections which are quite common in Nelson mufflers. For all sections, variable diameter pipes and chambers were now permitted. A pictorial description of these initial extensions to the NASA computer program is shown in Figure 7. Figure 8 shows a more detailed definition of how various example mufflers would be sectioned for inputting to the extended NASA computer program.

Using the sectional approach to the prediction of transmission loss for a particular muffler required internal modification to the flow logic of the NASA computer program. A flow diagram depicting how the transmission loss is determined by stepping individually through the sectional subroutines, compiling and storing the results until the complete muffler performance is printed out in either tabular and/or plotted form is shown in Figure 9. Sectioning of the exhaust system is performed by first defining the type of tailpipe radiation environment and proceeding up to and including the type of engine source impedance.

EXAMPLE OF COMPUTER-AIDED STUDY OF MUFFLER DESIGN

The extended computer program served a primary function of confirming, evaluating, predicting, etc, the theoretical transmission loss for experimental basic muffler models as they were evaluated using the impedance tube technique. Another function of the extended NASA computer program was its capability to perform analysis of muffler transmission loss behavior as a function of particular muffler design parameters. For example, consider the extended inlet-extended outlet expansion chamber muffler with both extensions initially one-fourth the length of the chamber. Keeping the distance between the internal ends of the extended inlet and extended outlet pipes constant, this fixed distance was then offset by the varying amount δ . See Figure 10. In Figure 10 below the sketch of the muffler being considered is a tabular example showing the changes in value of the quarter-wave length resonances with amount of offset δ . Figure 11 provides an appreciation of the resultant influence on transmission loss for several values of offset δ . Generalized curves representing the behavior of the resonant frequencies are shown in Figure 12. Observe that as the centered fixed distance representing a double resonant frequency at say 1000 hz is offset to the maximum value, the one resonant frequency for the lengthening inlet (or lengthening outlet) approaches one half its initial value or 500 hz, while the other resonant frequency for the shortening outlet (or shortening inlet) rapidly increases toward infinity. Of additional note is the decreasing resonant frequency from 3000 hz to 1500 hz with offset distance δ which could contribute to certain advantageous transmission loss features in specific situations. Many such parametric studies of muffler geometry, etc can be conceived and readily performed using the extended computer program.

POTENTIAL ADDITIONS TO FURTHER EXPAND COMPUTER DESIGN CAPABILITIES

With the computer program operational and functioning both in its initial intended role as a compliment to the impedance tube study and in its inherent capacity to perform parameter variation studies of muffler performance, projections were made at the end of the ten weeks of possible additional extensions that could contribute to the further development of the extended NASA computer program. These extensions included a) sectional model for a flow reversing chamber muffler (6) and b) sectional model for a parallel duct muffler (7). Theoretical development and experimental verification both offer attractive encouragement to their possible inclusion in muffler systems. Descriptive and performance features from the literature for the flow reversing chamber muffler is shown in Figure 13. This type of chamber is quite common in commercial mufflers. A parallel duct muffler is described and experimental performance results shown in Figure 14. The experimental curve on the left shows quite good wideband transmission loss.

Addition of muffler sections such as these two mentioned offered increased improvement to the extended NASA computer program as it had been developed at that time about two years ago.

COMMENTS ON ADDITIONALLY EXPANDED CAPABILITIES OF COMPUTER PROGRAM

Growth of the computer-aided design capabilities for exhaust muffler analysis since the initial summer development work by the author has been quite substantial. Efforts by Nelson research personnel have made advances toward the addition of temperature gradient effects, reversing chambers, perforated

tubes, and higher-order modes within the exhaust system as well as the incorporation of engine source impedance description for permitting insertion loss prediction. Experimental work is currently being undertaken at West Virginia University to better define engine source impedance for use in the computer program.

The principal uses made of this continuously expanding computer-aided approach for muffler design by Nelson Industries have been 1) as the theoretical predictor of transmission loss for conceptual mufflers and large industrial silencers proposed by persons within and outside the Research Department, and 2) as the analytical complement to assist the direction of experimental bench and/or laboratory engine muffler development research projects, such as the initially intended impedance tube muffler development study (8). Evidence of the computer program's successful application as a complement to experimental engine-exhaust system studies in terms of providing analytical comparison prediction plots is provided by Figures 6, 11, 12 and 13 of the paper by Larry J. Eriksson entitled 'Power or Pressure - a Discussion of Current Alternatives in Exhaust System Acoustic Evaluation' presented at this Symposium. (Reference 9) Additional expression of the computer program availability for incorporation into experimental studies conducted at Nelson Industries can be found in Reference 10. Figure 15 and Figure 16 of this paper provide comparative analysis of the ability of the computer program to predict the measured acoustic performance of typical pass and plug exhaust mufflers respectively at engine operating conditions.

The optimization capability of the computer program has served a limited purpose and use to this time, mainly because its cost-effectiveness operation has not been totally explored.

APPLICABILITY OF COMPUTER PROGRAM IN REGULATORY MUFFLER LABELING

In regards to the possible applicability of this analytical simulation technique toward usefulness as a 'bench test' methodology in regulatory muffler labeling, the following four statements seem appropriate: 1) this 'methodology' potentially can "measure" (by theoretical calculation) the noise reduction characteristics (transmission loss, insertion loss, etc.) of engine-exhaust systems, assuming continued successful efforts toward definition of muffler sectional configurations, engine source impedance, etc.; 2) this 'methodology' can communicate the noise reduction characteristics by means of single number (overall) and frequency band (third octave, etc) evaluation and could compare these evaluations with any applicable standards. Also, through a design optimization procedure, suggestions for exhaust system improvement might be made; 3) this 'methodology' cannot provide "total vehicle" evaluation toward labeling of surface transportation vehicles with respect to all possible vehicle noise sources; 4) this 'methodology' might provide information which would be compatible with regulatory policy once the regulatory policy itself is eventually formulated. Currently, this 'methodology' is quite useful for muffler design purposes which was its initial intent.

SELECTED REFERENCES

1. Sneckenberger, J. E., "Some Progress in Computer-Aided Design for Analysis and Optimization of Basic Exhaust Systems", Eighth Annual Noise Control in Internal Combustion Engine Seminar, 23 pp., January 1976.
2. Munjal, M. L., "Velocity Ratio-Cum-Transfer Method for the Evaluation of a Muffler with Mean Flow", J. Sound and Vibrations, Vol. 39, No. 1, pp. 105-19, March 1975.
3. Karnopp, D. C., Dwyer, H. A. and Margolin, D. L., "Computer Prediction of Power and Noise for Two-Stroke Engines with Power Tuned, Silenced Exhausts", SAE Paper 750708, 14 pp., August 1975.
4. Young, C. J. and Crocker, M. J., "Prediction of Transmission Loss in Mufflers by the Finite Element Method", J. Acoustical Society of America, Vol. 57, No. 1, pp. 144-8, January 1975.
5. Alfredson, R. J. and Davies, P.O.A.L., "Performance of Exhaust Silencer Components", J. Sound and Vibrations, Vol. 15, No. 2, pp. 175-96, April 1971.
6. Tangcharat, P. and Diboll, W. B., "Adjoint Inlet-Outlet Quarter-Wave Length Muffler", Proceedings: 1973 Noise-Con, pp.212-7, October 1973.
7. Patrick, W. P., "Systematic Method to Determine the Acoustical Characteristics of Series-Parallel Duct Configurations Using Transmission Matrices", Proceedings: Third Interagency Symposium on University Research in Transportation Noise", pp. 533-45, November 1975.
8. Flanders, D. C., "Impedance Tube: A Tool for the Research and Development of Basic Muffler Elements", Eighth Annual Noise Control in Internal Combustion Engine Seminar, 32 pp., January 1976.
9. Eriksson, L. J., "Power or Pressure - A Discussion of Current Alternatives in Exhaust System Acoustic Evaluation", EPA Surface Transportation Exhaust Noise Symposium, 33 pp., October 1977.
10. Olson, D. A., Nordlie, K. D. and Seils, E. J., "Techniques and Problems of Truck Exhaust System Noise Measurement", SAE Paper 770895, 14 pp., October 1977.

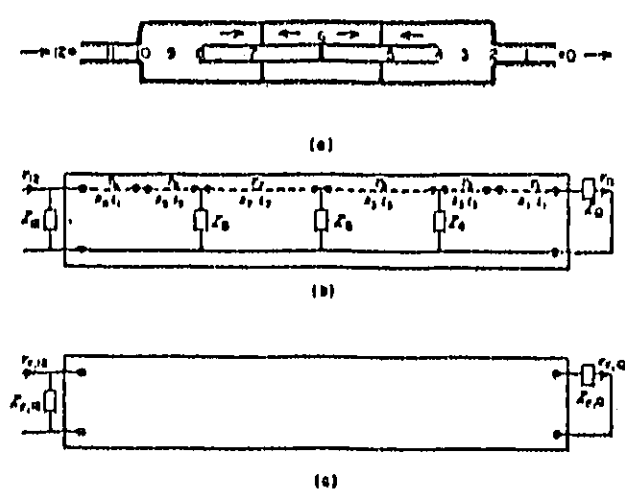

(a) A TYPICAL STRAIGHT-THROUGH EXHAUST MUFFLER
 (b) ANALOGOUS CIRCUIT FOR THE EVALUATION OF VR_{n+1}
 (c) ANALOGOUS CIRCUIT FOR THE EVALUATION OF $VR_{c,n+1}$

Figure 1. FORMULATION FOR VELOCITY RATIO-CUM-TRANSFER MATRIX METHOD.

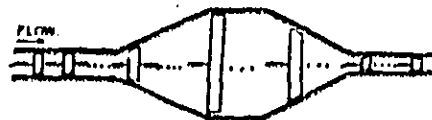

(a)

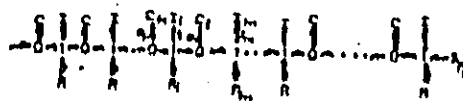

(b)

(a) MODEL OF EXPANSION CHAMBER MUFFLER

(b) EQUIVALENT BOND GRAPH FOR MUFFLER

Figure 2. FORMULATION FOR BOND GRAPH METHOD.

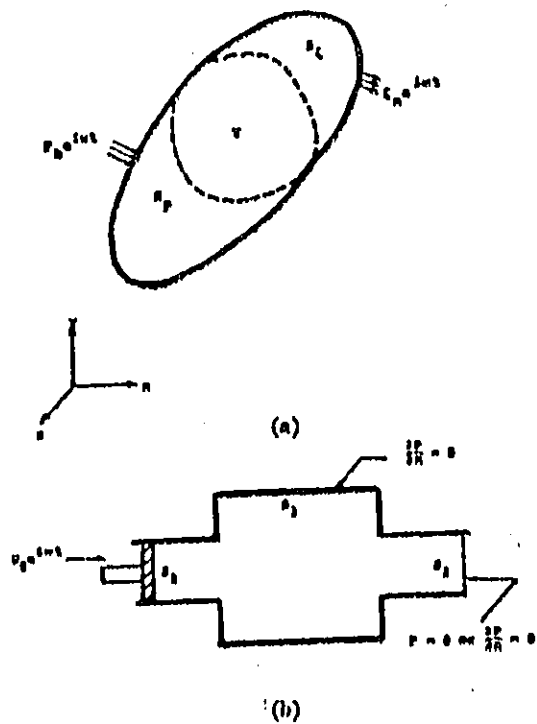

(a) GENERALIZED ACOUSTICAL SYSTEM
 (b) FORMULATION APPLIED TO EXPANSION CHAMBER MUFFLER

Figure 3. FORMULATION FOR VARIATIONAL METHOD.

BEST AVAILABLE COPY

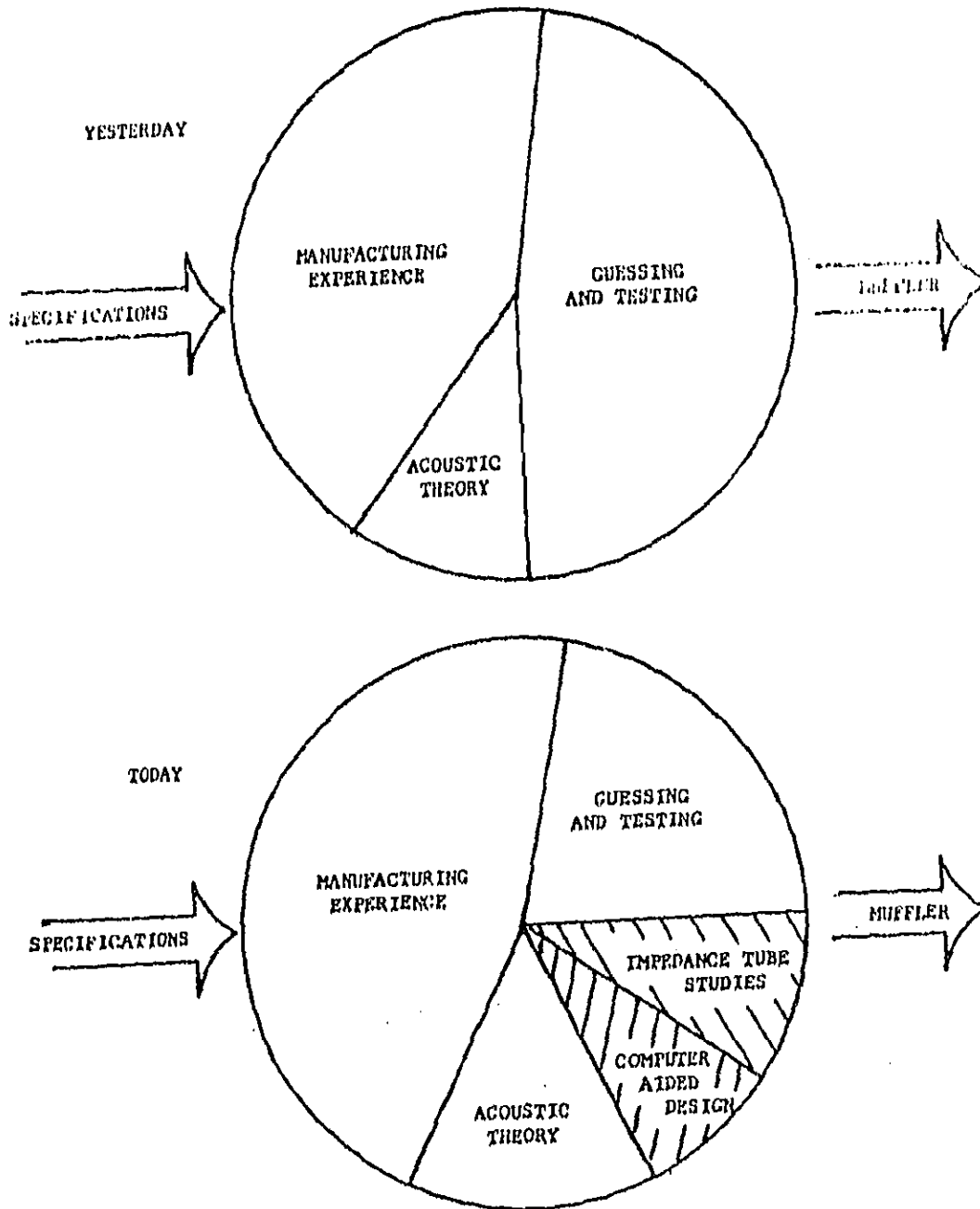
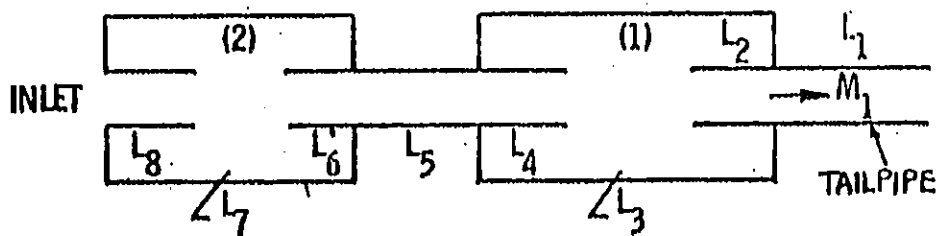

Figure 4. COMBINED IMPEDANCE TUBE-COMPUTER PROGRAM APPROACH.

NASA TN D-7309

AN IMPROVED METHOD FOR DESIGN OF EXPANSION-CHAMBER MUFFLERS WITH APPLICATION TO AN OPERATIONAL HELICOPTER

KEY FEATURES OF COMPUTER PROGRAM



- CALCULATES TRANSMISSION LOSS
- HANDLES UP TO FIVE EXPANSION CHAMBERS
- INCLUDES MEAN FLOW EFFECTS
- VARIES COMPONENT LENGTHS WITHIN SPECIFIED LIMITS TO OPTIMIZE PERFORMANCE

Figure 5. FEATURES OF NASA MUFFLER DESIGN COMPUTER PROGRAM.

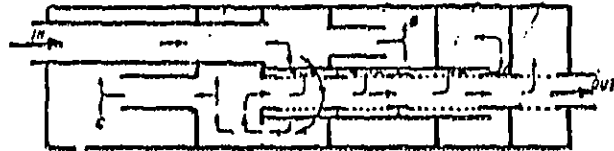

(a)

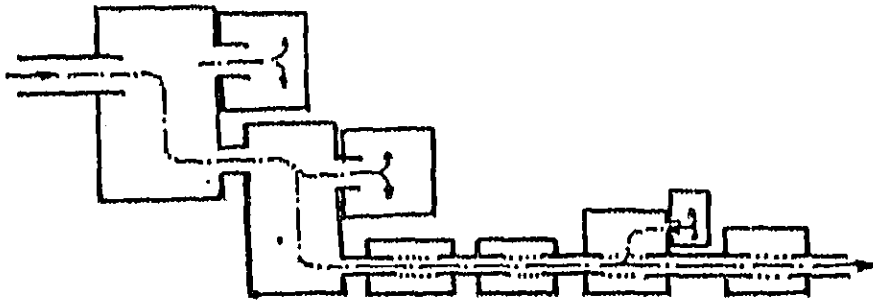

(b)

(a) as constructed

(b) as unfolded

Figure 6. UNFOLDED VERSION OF A TWO TUBE-THREE PASS MUFFLER.

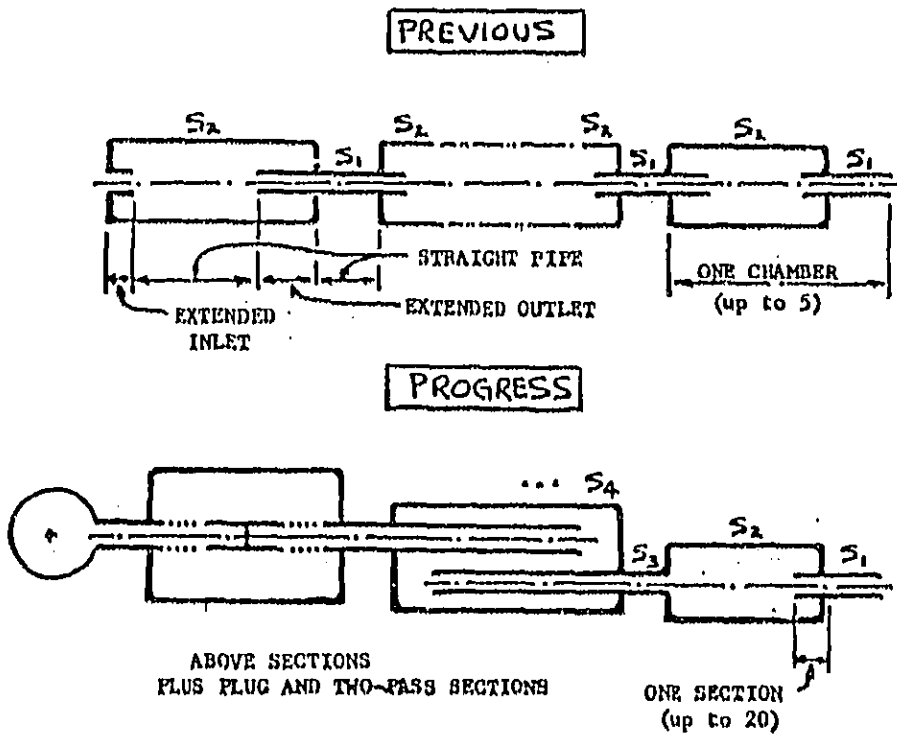
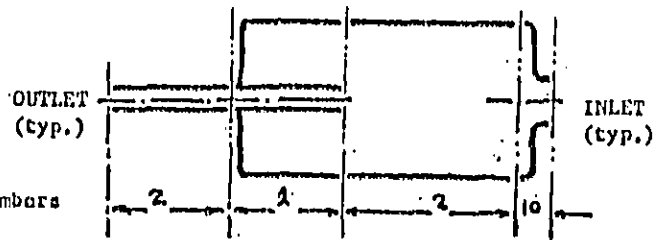

Figure 7. EXTENSIONS TO NASA MUFFLER DESIGN COMPUTER PROGRAM.

REF ID: A611 431 E 0304

EXAMPLE
1



EXAMPLE
2

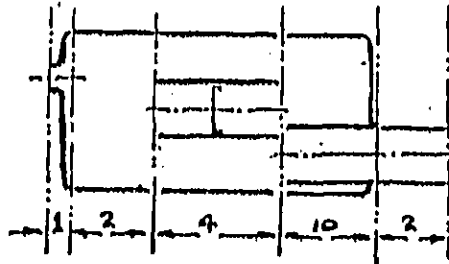

EXAMPLE
3



Figure 8. EXAMPLES OF SECTIONING OF EXHAUST MUFFLERS.

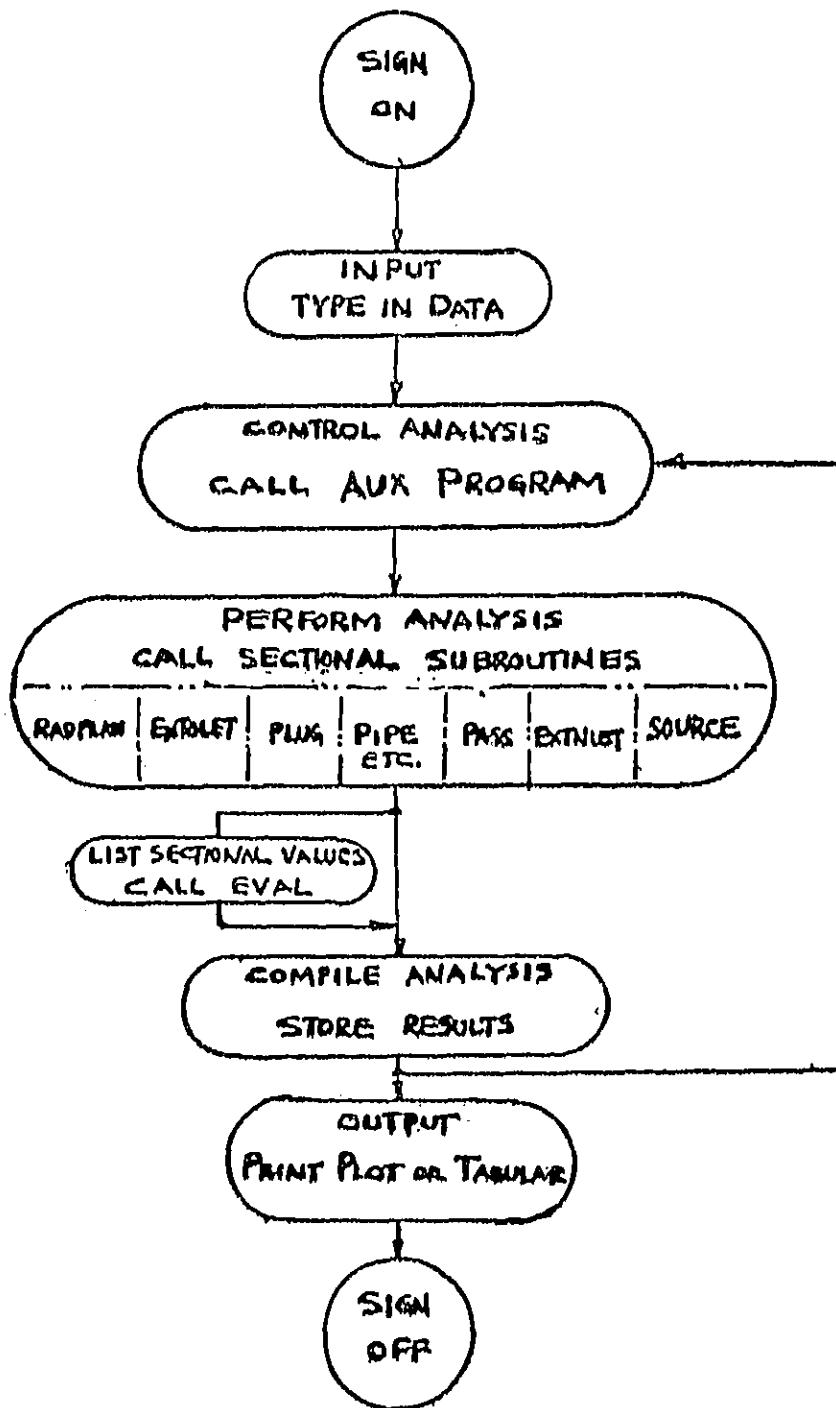
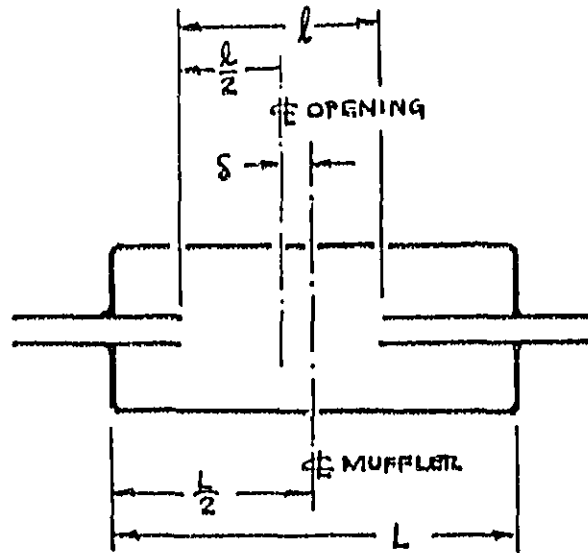

Figure 9. FLOW DIAGRAM FOR SECTIONALIZED MUFFLER DESIGN COMPUTER PROGRAM.

BEST AVAILABLE COPY



EXTENDED INLET AND OUTLET MUFFLER WITH OFFSET OPENING

TABULAR EXAMPLE

Given $L = 14.4$ inches; for $l = 7.2$ inches

δ (m)	f_1	f_2	f_3	f_4
0	1000	1000	3000	3000
.5	877	1163	2631	.
1.0	780	1380	2340	.
1.5	710	1710	2130	.
2.0	645	1945	1935	.
2.5	600	2221	1800	.
3.0	540	4732	1620	.
3.6	500	∞	1500	.

Figure 10. EXAMPLE OF STUDY USING MUFFLER DESIGN COMPUTER PROGRAM.

REST AVAR AIR E OGGV

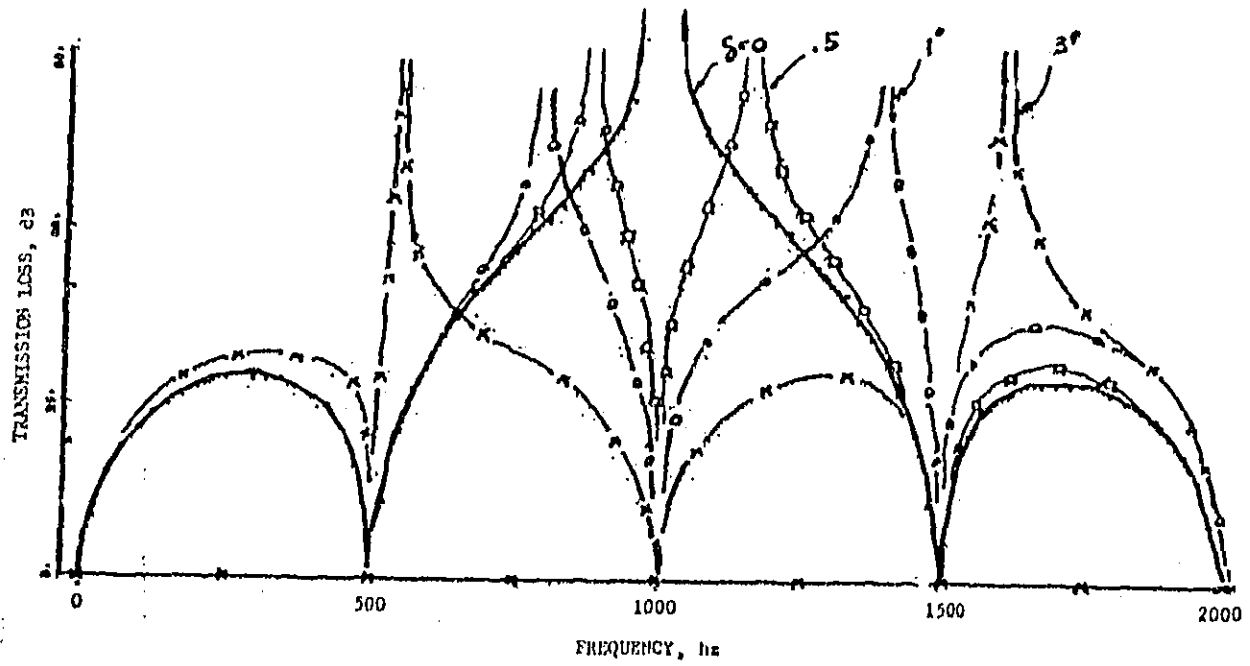

Figure 11. FAMILY OF TRANSMISSION LOSS CURVES FOR SEVERAL AMOUNTS OF OFFSET PIPE OPENING.

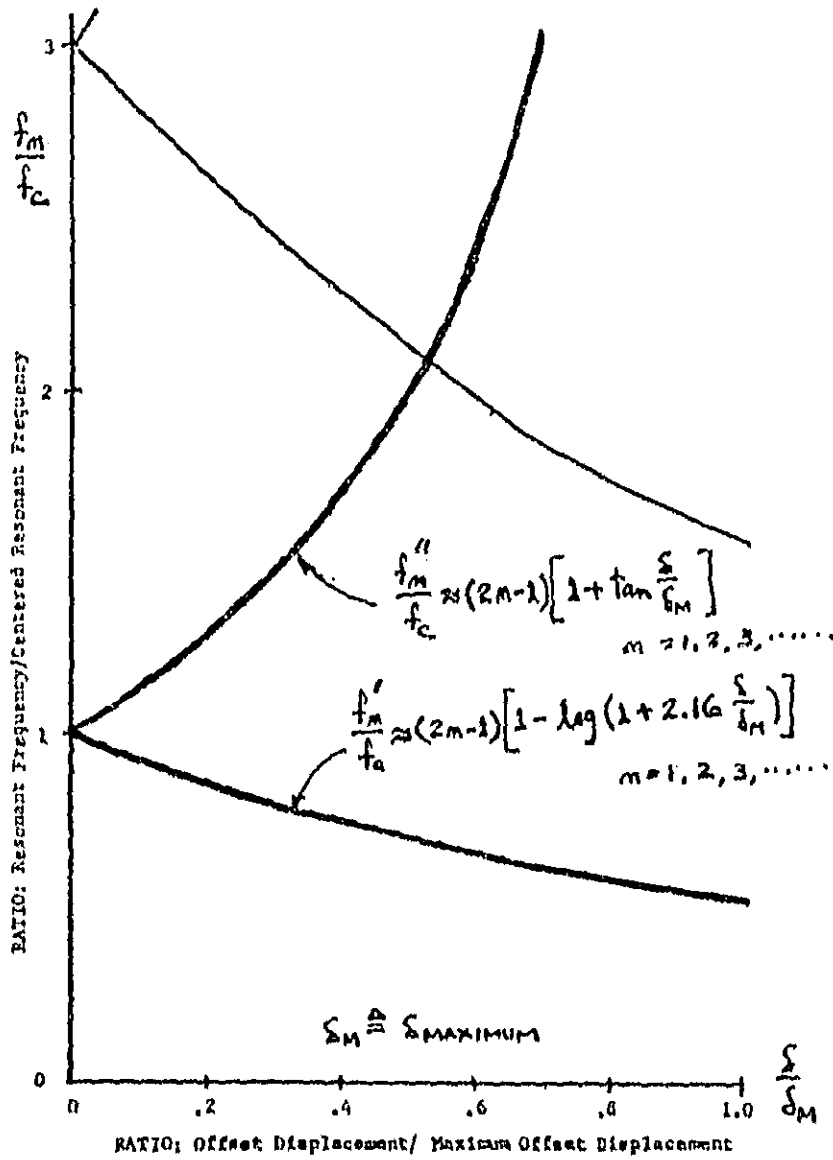
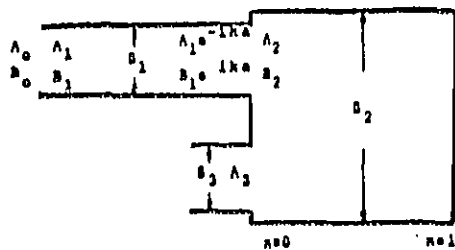

Figure 12. GENERALIZED CURVES FOR RESONANT FREQUENCY VS OFFSET DISPLACEMENT.



(a)



Tailpipe = 1 ft

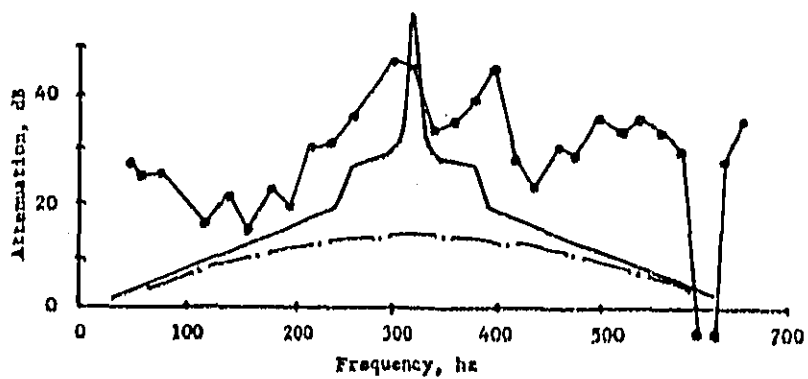

(b)

(a) theoretical model for Flow Reversing Chamber Muffler.

(b) Measured Transmission Loss for Flow Reversing Chamber Muffler.

Figure 13. DESCRIPTION AND PERFORMANCE OF FLOW REVERSING CHAMBER MUFFLER.

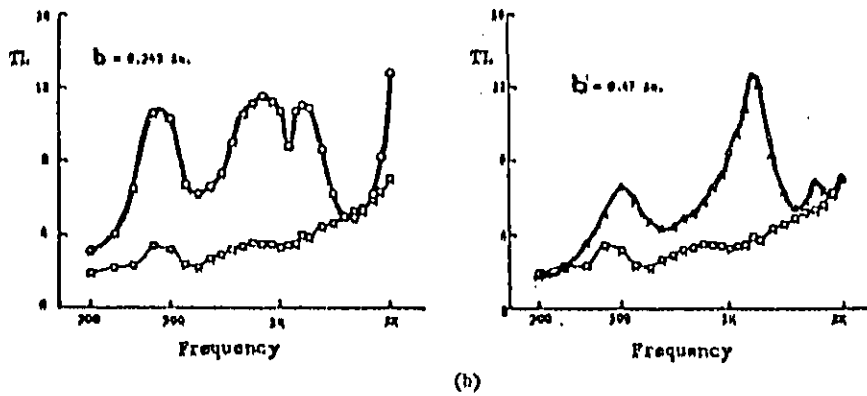
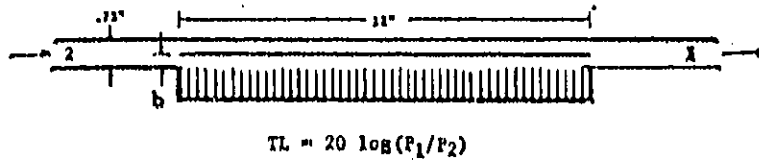
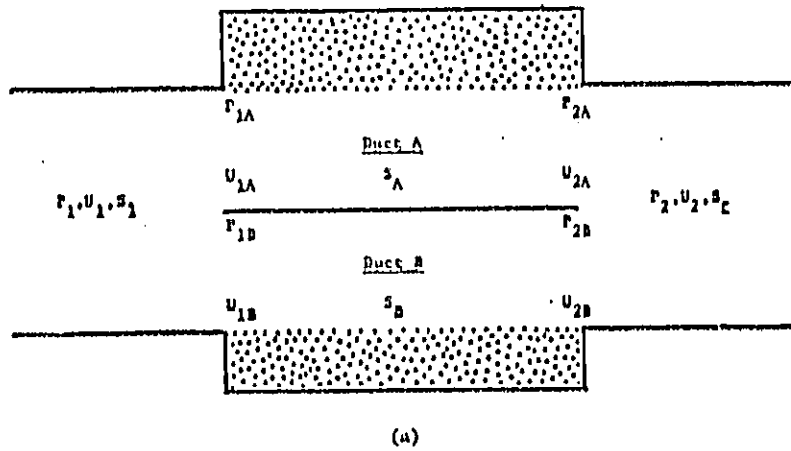

(a) Theoretical Model for Parallel Absorptive Duct Muffler.
 (b) Measured Transmission Loss for Parallel Absorptive Duct Muffler.

Figure 14. DESCRIPTION AND PERFORMANCE OF PARALLEL DUCT MUFFLER.

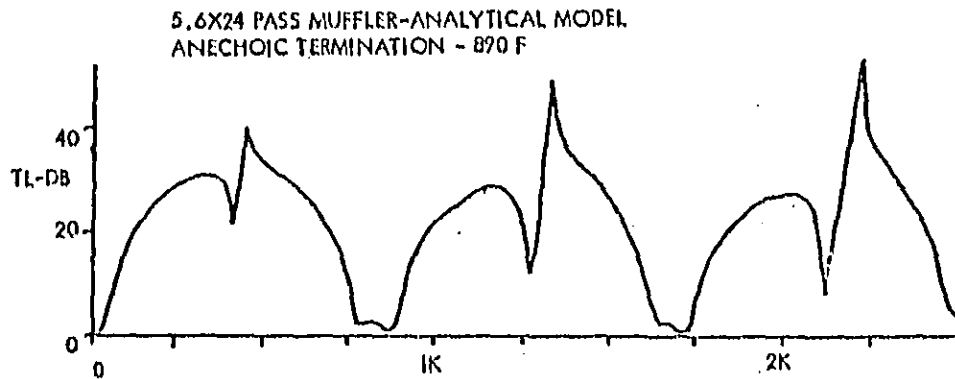
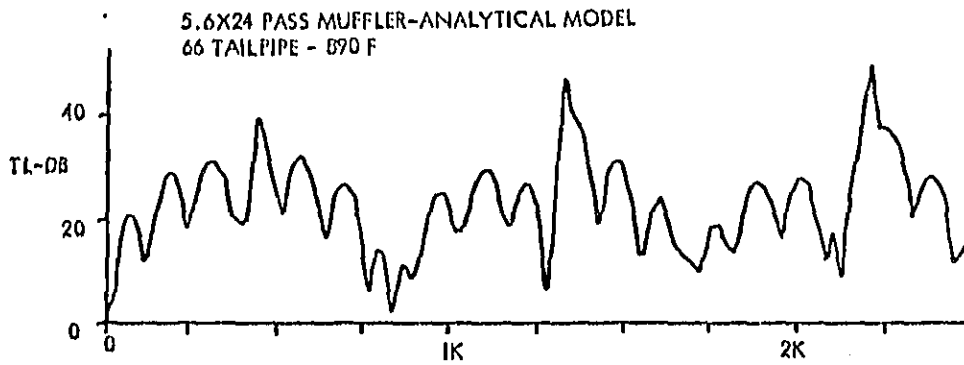
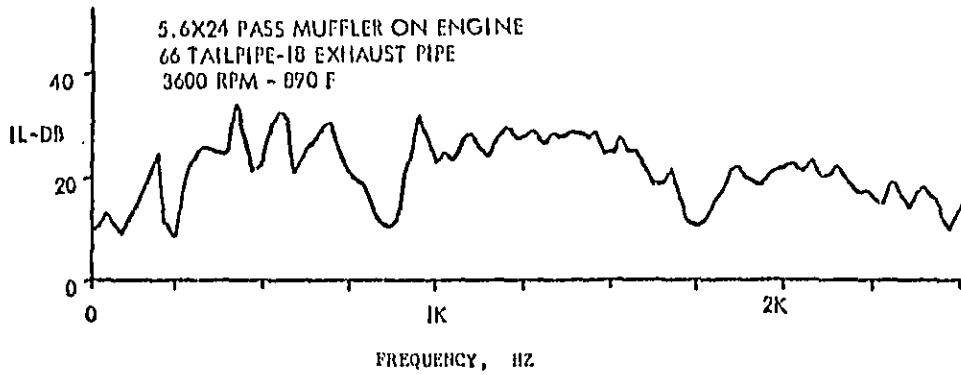

Figure 15. Analytical and Experimental Results for a Pass Muffler.

REST AVAIL ABLE COPY

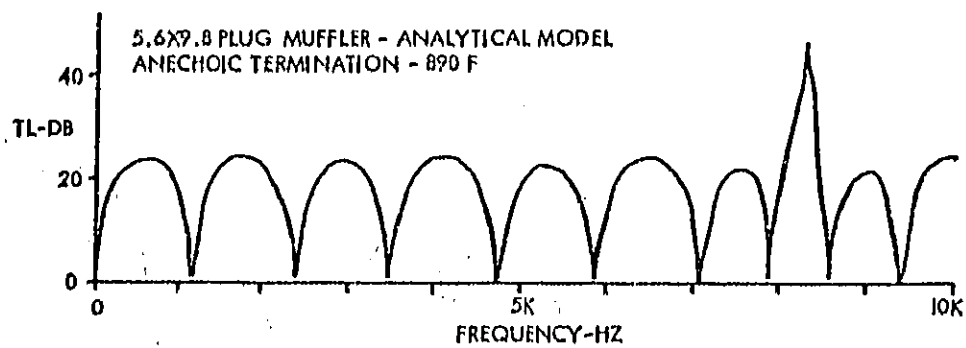
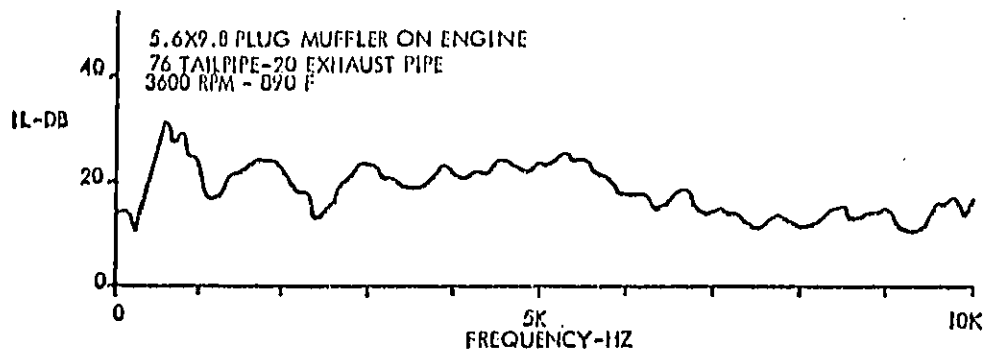

Figure 16. Analytical and Experimental Results for a Plug Muffler.

REVIEW OF INTERNAL COMBUSTION
ENGINE EXHAUST MUFFLING

by

Malcolm J. Crocker
Ray W. Herrick Laboratories
School of Mechanical Engineering
Purdue University
West Lafayette, Indiana, USA

SUMMARY

This paper will describe types of mufflers in existence, discuss definitions of muffler performance, briefly review historically some of the theory developed to predict muffler acoustic performance, describe some of the work done at the Herrick Laboratories on predicting muffler attenuation, and lastly comment on the possibility of designing a practical bench test for a muffler which does not involve an engine as a source.

INTRODUCTION

Exhaust noise is the predominant noise source with most internal combustion engines and thus mufflers and silencers have been designed to reduce this noise. Unfortunately, although the acoustic performance of a muffler can sometimes be successfully predicted in the laboratory with artificial (loudspeaker type) sources,

until recently most attempts to predict the performance of a muffler on an engine have been disappointing. However, in the last few years progress has been made and now prediction of the acoustic performance of real mufflers on engines can be made with more accuracy, although unknown effects still remain.

Most muffler designs manufactured still rely heavily on a great deal of empiricism, experience and experiment. Recent U.S. legislation to improve fuel efficiency of automobiles has produced increased pressure to save weight in mufflers and optimize acoustic performance. It is to be expected that this pressure will increase efforts to improve theoretical models of the acoustic performance of mufflers still further in the near future.

MUFFLER CLASSIFICATION

Mufflers can be classified into two main types, reactive and dissipative. Reactive mufflers are composed of chambers of different volume and shape and work by reflecting most of the incident acoustic energy back towards the source (the engine). Dissipative mufflers on the other hand are lined with acoustic material which absorbs the sound energy and converts it into heat [1,2,3]. Mufflers can be designed to be partly reactive and partly dissipative and in fact some internal combustion engine mufflers do sometimes incorporate absorbing materials. However,

this material usually deteriorates because of the severe temperature conditions and becomes clogged, melts or fatigues. Thus most automobile mufflers manufactured today are of the reactive type and do not incorporate absorbing materials. Nevertheless some dissipation can still occur in a reactive muffler due to viscous dissipation.

Reactive mufflers can be further subdivided into straight-through and reverse-flow types [4,5]. Figure 1 shows some typical straight-through types. These mufflers are usually comprised mainly of expansion chambers (chambers in which the area is suddenly increased then decreased) and concentric tube resonators (side branch Helmholtz resonators). Reverse-flow types can be built in many different configurations. A typical reverse-flow muffler is shown in Figure 2. Figure 3 shows a photograph of another similar reverse-flow muffler. As shown such mufflers consist of several chambers connected by straight pipes. There are usually two end chambers in which the flow is reversed and one or more large low-frequency Helmholtz resonators. Sometimes louver patches are used to produce side branch Helmholtz resonators (which reflect high frequency noise). In addition cross flow is often allowed to occur and attenuation is then created by interference of sound traveling over different path lengths. Most automobile mufflers are of the reverse-flow type, although trucks

SECRET AVIATION LIBRARY

can use either reverse-flow or straight through mufflers.

DEFINITIONS

The definitions of muffler performance in most common use will be given here [5,6,7,8]. It should be noted, however, that some authors use different nomenclature and confusion can sometimes arise.

- A. Insertion Loss (IL). This is the difference in the sound pressure level measured at one point in space with and without the muffler inserted between that point and the source [7,8]. Insertion loss is a convenient quantity to measure and its use is favored by manufacturers.
- B. Transmission Loss (TL). This is defined as $10 \log_{10}$ of the ratio of the sound power incident on the muffler to the sound power transmitted. This is the quantity which is most easily predicted theoretically and its use is favored by those engaged in research.
- C. Noise Reduction (NR). This is the difference in sound pressure levels measured upstream and downstream of the muffler.
- D. Attenuation. This is the decrease in propagating sound power between two points in an acoustical system. This quantity is often used in describing absorption in lined ducts where the decrease in sound pressure level per unit length is measured [7,8].

The first three definitions are used frequently in work on mufflers for automobile engines and they are illustrated in Figure 4. It is of interest to note that these definitions are also used with similar meanings to describe sound transmission through walls or enclosures.

In general, the insertion loss, the transmission loss and the noise reduction are not simply related, since, except for the transmission loss, they depend on the internal impedance of the source (engine) and the termination impedance (radiation impedance of the tail pipe). However, if the source and termination impedances are equal to $\rho c/S$ (i.e., the source and the termination are non-reflecting), then

$$\begin{aligned} & \text{IL} = \text{TL} < \text{NR}, \\ \text{and usually,} & \text{NR} - \text{TL} = 3\text{dB}. \end{aligned}$$

DEVELOPMENT OF MUFFLER THEORIES

Although Quincke in the last century discussed the interference of sound propagation through different length pipes, theory of real use in muffler design was not developed until the 1920's. This was probably partly because prior to this time it was difficult (if not impossible to measure sound pressure quantitatively) due to the lack of suitable microphones and partly due to less need, because of the lower noise produced by engines.

In 1922 Stewart, in the USA began developing acoustic filter theory using a lumped parameter approach [9]. In 1927 Mason developed this theory further [10]. In Britain and Germany in the 1930's work was conducted on designing mufflers for aircraft [11] and single cylinder engines [12].

However it was not until the 1950's when another significant improvement in muffler theory occurred. Davis and his co-workers [13,14] then developed theory for plane wave propagation in multiple expansion chambers and side branch resonators. They made many experiments and found that in general their predictions of transmission loss were good provided the cut-off frequency in the pipes and chambers was not exceeded in practice. Above this frequency, cross modes in addition to plane waves can exist and one of their theoretical assumptions was violated.

When Davis et al tried to use their theory to design a helicopter muffler, their prediction was very disappointing, since they only measured about 10 dB insertion loss, compared with the 20 dB they had expected from their transmission loss theory. Davis et al tried to explain this by saying that finite amplitude wave effects must be important. However a more likely reason is their neglect of mean flow which can be of particular importance in insertion loss predictions. For a more complete discussion of the assumptions made by Davis et al in their theory see [5].

In the late 1950's Igarashi et al began to calculate the transmission properties of mufflers using equivalent electric circuits [15,16,17]. This approach is very convenient. The total acoustic pressure and total acoustic volume velocity are related before and after the muffler by using the product of four-terminal transmission matrices for each muffler element [5]. The equivalent electrical analog for a muffler is quite convenient since electrical theory and insight may be brought to bear. The four-terminal transmission matrices are also useful since it is only necessary to know the four parameters A, B, C, D which characterize the system. The parameter values are not affected by connections to elements upstream or downstream as long as the system elements can be assumed to be linear and passive.

Several transmission matrices have been evaluated for various muffler elements by Igarashi et al [15,16,17] and Fukuda et al [21,22,23]. Parrott [18] also gives results for transmission matrices, some of which include the effects of a mean flow. However, note that the matrix given for a straight pipe carrying a mean flow of Mach number M (equation 28 in [18]) is in error. Sullivan has given the corrected result in [24].

In the middle and late 1960's and early 1970's several workers including first Davies [25,26] and then Blair, Goulbourn, Benson, Baitea and Coates [27-32] developed an alternative method of predicting muffler

performance based on shock wave theory. Perhaps this work was inspired by Davis's belief [13] that the failure of his helicopter muffler design was caused by the fact exhaust pressures are much greater than normally assumed in acoustic theory so that finite amplitude effects become important. This alternative method involves the use of the method of characteristics and can successfully predict the pressure-time history in the exhaust system. Also, one-third octave spectra of the acoustic noise have been predicted [32]. However, the method is time consuming and expensive and has difficulties in dealing with complex geometries and some boundary conditions.

Although such an approach is probably necessary and useful with the design of mufflers for single cylinder engines, so far this method has found little favor with manufacturers of mufflers for multicylinder engines. It appears furthermore that Davis's belief [13] may have been incorrect. There are several other possible reasons why Davis failed to obtain better agreement between theory and experiment, each of which can be important. These include [33]: neglect of mean gas flow (and its effect on net energy transport), incorrect boundary conditions for exhaust ports and tail pipe, neglect of interaction between mean gas flow and sound in regions of disturbed flow, and, neglect of mean temperature gradients in the exhaust system.

In 1970 Alfredson and Davies published work which shed new light on the acoustic performance of mufflers [33,34,35,36,37]. Alfredson working at Southampton University mainly considered the design of long expansion chamber type mufflers commonly used on diesel engines. Alfredson's work has been important since he has shown that (at least with the mufflers and engine he studied) that acoustic theory could be used to predict the radiated exhaust sound and the transmission loss of a muffler and that finite amplitude effects could be neglected, provided that mean gas flow effects were included in the theory. Alfredson concluded that as the mean flow Mach number approached $M = 0.1$ or 0.2 in the tail pipe, the zero flow theory overpredicted the muffler effectiveness by 5 to 10 dB or more. The most serious discrepancy occurred for values of reflection coefficient $R \rightarrow 1$. This would occur for low frequency (large wavelength). Alfredson computed this error to be

$$\text{Error} = 10 \log_{10} \{ [(1 + M)^2 - (1 - M)^2 R^2] / [1 - R^2] \} \quad (1)$$

and the result is plotted in Figure 5.

As a check on his acoustic theory and on Equation (1), Alfredson later measured the attenuation of an expansion chamber and compared it with theory [35]. The result is shown in Figure 6. The good agreement between theory (with flow included) and experiment and poor agreement with theory when flow was neglected seem to confirm

BEST AVAILABLE COPY

that acoustic theory is probably adequate in many instances in muffler design provided the effects of mean flow are included in the model where necessary. These conclusions are very important.

Another new development occurred in 1970 when Young and Crocker began the use of finite elements to analyze the transmission loss of muffler elements [38]. The reason for the use of finite elements is that some chambers in reverse-flow mufflers (e.g., flow-reversing end chambers and end-chamber/Helmholtz-resonators combinations) are not axi-symmetric and thus difficult, if not impossible, to analyze using classical assumptions of continuity of pressure and volume velocity at discontinuities, even in the plane wave region. The use of a numerical technique such as finite element analysis makes the acoustic performance of complicated-shaped chambers possible to predict even in the higher frequency cross-mode region. The work of Young and Crocker [38,39,40,41,42] will be described in some detail later in this paper.

Other investigators have since used finite elements in muffler design. Kagawa and Omote [43] have used two-dimensional triangular ring elements. Craggs [44] has used isoparametric three-dimensional elements, while Ling [45], using a Galerkin approach, included mean flow in his acoustic finite element model. However, Ling's work was mainly concentrated on propagation in ducts rather than muffler design.

Side branch resonators (known by manufacturers as bead cans or spit chambers), see Figures 2 and 3, have recently been studied by Sullivan and Crocker [46,47] in practical situations, axial standing waves can exist in the outer concentric cavity of the resonator. Previous theories have been unable to account for this phenomenon (assuming the cavity acts like a lumped parameter stiffness). Sullivan's work will be described in more detail later in the paper.

Other developments in muffler design have included the Bond Graph approach by Karnopp [48,49]. It is claimed that this approach can extend the frequency range of lumped parameter filter elements.

Another important topic little touched on so far is the effect of flow in mufflers. Various phenomena can occur. Noise can be generated by the flow process. Interactions can occur between the flow and sound waves. Fricke and Crocker found that the transmission loss of short expansion chambers could be considerably reduced [50]. The effect appeared to be amplitude dependent and a feedback mechanism was postulated. Kirata and Itow [51] have studied the influence of air flow on side branch resonators and concluded that the peak attenuation is considerably reduced by flow. Anderson [52] has concluded that a mean air flow causes an increase in the fundamental resonance frequency of a simple single side-branch Helmholtz resonator connected to a duct.

REST AVAILABLE ONLY

Perhaps the most important development recently is the two microphone method for determining acoustic properties described by Seybert and Ross [53] in work conducted at the Herrick Laboratories. White noise is used as a source. Two flush-mounted wall microphones are used and measurements of the auto and cross spectra enable incident and reflected wave spectra and the phase angle between the incident and reflected waves to be determined. The method can be used to measure impedance and transmission loss. Agreement between this two microphone random noise method and the traditional standing wave tube method is very good and the method is very much more rapid (only 7 seconds of data were used to obtain the plots given in Figures 7 and 8). Figure 7 shows a comparison between theory and experiment for the power reflection coefficient R^2 for an open end tube and the phase angle. Figure 8 shows the transmission loss, TL, of a prototype automobile muffler with a comparison between this method and the classical standing wave ratio (probe tube) method (SWR). For TL measurements, a third microphone was used downstream of the muffler.

CLASSICAL MUFFLER THEORY

A. Transmission Line Theory

We will first make some simplifying assumptions:

- a) sound pressures are small compared with the mean pressure,
- b) there are no mean temperature gradients or mean flow and

c) viscosity can be neglected. If plane waves are assumed to exist in a muffler element (see Figure 9) then the acoustic pressure p anywhere in the muffler element can be represented as the sum of left and right traveling waves p^+ and p^- respectively

$$p = p^+ + p^-, \quad (2a)$$

$$p = P^+ e^{-ikx} + P^- e^{ikx}, \quad (2b)$$

$$V = V^+ + V^-, \quad (3a)$$

$$V = (S/\rho c) (P^+ e^{-ikx} - P^- e^{ikx}), \quad (3b)$$

$$V = (S/\rho c) (p^+ - p^-). \quad (3c)$$

Note that p and V represent the magnitude (and phase) of the total acoustic pressure and volume velocity. The time dependence (constant multiplying factor $e^{i\omega t}$) has been omitted for brevity. The right and left traveling acoustic waves are represented by the $+$ and $-$ superscripts, respectively, while P represents the pressure amplitude, S the cross sectional area, $\rho c/S$ the characteristic acoustic impedance (traveling wave pressure divided by traveling wave volume velocity), $k = \omega/c$, the acoustic wave number, ω the angular frequency, c the speed of sound, and ρ the fluid density.

Davis et al used theory such as this to predict the transmission loss of various expansion chamber type mufflers [13,14] by assuming 1) continuity of pressure and 2) continuity of volume velocity at discontinuities.

For example if there is a sudden increase in area at station 1 and a sudden decrease in area at station 2, then the chamber is known as an expansion chamber and its transmission loss is given by:

$$TL = 10 \log(|P_i/P_t|)^2,$$

$$TL = 10 \log_{10} \left[1 + \frac{1}{4} (m - 1/m)^2 \sin^2 kL \right]. \quad (4)$$

Equation (4) is easily derived from equations (2) and (3) above by assuming the sudden area changes occur at $x = 0$ and $x = L$ and by assuming the continuity of pressure and volume velocity at the area discontinuities. In Equation (4), P_i and P_t are the pressure amplitudes of the right traveling waves incident and transmitted by the expansion chamber. Figure 10 gives a comparison between theory (Equation (4)) and experiment from Davis et al [13,14].

B. Transfer Matrix Theory

An alternative approach is to assume that the pressure p and volume velocity V at stations 1 and 2 in Figure 9 can be related by:

$$P_1 = AP_2 + BV_2, \quad (5)$$

and

$$V_1 = CP_2 + DV_2. \quad (6)$$

An electrical circuit analogy can be used where the pressure p is analogous to voltage and volume velocity V

to current. This is known as the impedance analogy. Note that an alternative mobility analogy is sometimes used [5]. The circuit element can be represented by the four pole element shown in Figure 11. If the muffler section is simply a rigid straight pipe of constant cross-section, then from Equations (2b) and (3b), the pressure and volume velocity at stations 1 and 2 are:

$$P_1 = P^+ + P^-, \quad (7)$$

$$P_2 = P^+ e^{-ikL} + P^- e^{ikL}, \quad (8)$$

$$V_1 = (S/\rho c) (P^+ - P^-), \quad (9)$$

and
$$V_2 = (S/\rho c) (P^+ e^{-ikL} - P^- e^{ikL}). \quad (10)$$

The parameters A, B, C and D may be evaluated using a "black box" system identification technique. To evaluate A and C, assume that the matrix output terminals are open circuit, or $V_2 = 0$. Then Equation (10) gives $P^+/P^- = e^{i2kL}$ and Equations (5) and (6) give: $A = P_1/P_2$ and $C = V_1/P_2$. Using this result for P^+/P^- , and Equations (7), (8) and (9), after some manipulation, it is found that $A = \cos kL$ and $C = (S/\rho c) i \sin kL$. Similarly, to evaluate B and D assume that the matrix output terminals are short-circuited and $P_2 = 0$. Then Equation (8) gives $P^+/P^- = -e^{i2kL}$ and Equations (5) and (6) give $B = P_1/V_2$ and $D = V_1/V_2$. Using this result for P^+/P^- and Equations (7), (9) and (10), it is found that $B = (\rho c/S) i \sin kL$ and $D = \cos kL$.

Substituting these results for A, B, C and D into Equations (5) and (6) and writing them in matrix form gives:

$$\begin{bmatrix} P_1 \\ V_1 \end{bmatrix} = \begin{bmatrix} A & B \\ C & D \end{bmatrix} \begin{bmatrix} P_2 \\ V_2 \end{bmatrix}, \quad (11)$$

where the four pole constants (for a straight pipe of length L) are:

$$\begin{bmatrix} A & B \\ C & D \end{bmatrix} = \begin{bmatrix} \cos kL & i(\rho c/S)\sin kL \\ i(S/\rho c)\sin kL & \cos kL \end{bmatrix}. \quad (12)$$

Note that $AD - BC = 1$. This is a useful check on the derived values of the four-pole parameters and is a consequence of the fact that the system obeys the reciprocity principle [5]. The matrix in Equation (12) relates the total acoustic pressure and volume velocity at two stations in a straight pipe.

If several component systems are connected together in series, as in Figure 12 then the transmission matrix of the complete system is given by the product of the individual system matrices:

$$\begin{aligned} \begin{bmatrix} P_1 \\ V_1 \end{bmatrix} &= \begin{bmatrix} A_1 & B_1 \\ C_1 & D_1 \end{bmatrix} \begin{bmatrix} P_2 \\ V_2 \end{bmatrix} \\ &= \begin{bmatrix} A_1 & B_1 \\ C_1 & D_1 \end{bmatrix} \begin{bmatrix} A_2 & B_2 \\ C_2 & D_2 \end{bmatrix} \begin{bmatrix} P_3 \\ V_3 \end{bmatrix} \\ &= \begin{bmatrix} A_1 & B_1 \\ C_1 & D_1 \end{bmatrix} \begin{bmatrix} A_2 & B_2 \\ C_2 & D_2 \end{bmatrix} \begin{bmatrix} A_3 & B_3 \\ C_3 & D_3 \end{bmatrix} \begin{bmatrix} P_4 \\ V_4 \end{bmatrix}. \end{aligned} \quad (13)$$

This matrix formulation is very convenient particularly where a digital computer is used. The four pole constants A, B, C and D can be found easily for simple muffler elements such as expansion chambers and straight pipes as has just been shown (see Equation (12)). They can also be found in a similar manner for more complex muffler shapes (reversing end-chambers and reversing end-chamber/Helmholtz resonator combinations) by the finite element method using the same black box identification technique mentioned above (with alternatively $P_2 = 0$ and $V_2 = 0$).

EXHAUST SYSTEM MODELING

It will now be shown that for any linear passive muffler element that the transmission loss is a property only of the muffler geometry (i.e., four-terminal constants A, B, C and D) and unaffected by connection of subsequent muffler elements or source or load impedances. On the other hand, it will be shown that the insertion loss is affected by the source and load impedances. Finally if it is desired to predict the sound pressure level outside of the tail pipe it is necessary to have a knowledge not only of the source (engine) impedance and load impedance but also of the source (engine) strength - either pressure or volume velocity.

The transmission loss of a muffler is the quantity most easily predicted theoretically and is certainly of guidance in muffler design. However insertion loss or a prediction

of the sound pressure radiated from the tail pipe are much more useful to the muffler designer and these are now discussed.

A. Transmission Loss

The engine-muffler-termination system may be modeled as an equivalent electric circuit [19,20,24,54]. The velocity source model in Figure 13b will be used in the derivations of TL (although the pressure source model gives the same result). For simplicity, the mean-flow Mach number $M = 0$, the cross-sectional areas of the muffler inlet pipes S_0 are assumed equal and there is no mean temperature gradient in the muffler system. To determine the transmission loss, the incident and transmitted pressure amplitudes $|p_1^+|$ and $|p_2^+|$ are needed. The transmitted pressure $|p_2^+|$ is most easily determined by making the tail pipe non-reflecting ($Z_r = \rho c/S_0$). Thus $p_2^- = 0$.

From Figure 13b (see Equations (2a) and (3c)):

$$p_1 = p_1^+ + p_1^-, \quad (14)$$

$$v_1 = (S_0/\rho c)(p_1^+ - p_1^-), \quad (15)$$

$$v_2 = (S_0/\rho c)p_2^+, \quad (16)$$

and from Equation (11):

$$p_1^+ + p_1^- = A p_2^+ + B p_2^+(S_0/\rho c), \quad (17)$$

$$(S_0/\rho c)(p_1^+ - p_1^-) = C p_2^+ + D p_2^+(S_0/\rho c). \quad (18)$$

From the definition in Figure 4b:

$$TL = 10 \log_{10} \frac{|p_1^+|^2 / \rho c}{|p_2^+|^2 / \rho c} = 20 \log_{10} |p_1^+|^2 / |p_2^+|^2. \quad (19)$$

Then eliminating p_1^- in Equations (17) and (18) and substituting into Equation (19) gives:

$$TL = 20 \log_{10} (|A + B(S_0/\rho c) + C/(S_0/\rho c) + D|/2). \quad (20)$$

Equation (20) is a similar result to that obtained by Young and Crocker [40]. Except note that in [40] particle velocity was used instead of volume velocity and so A, B, C and D have slightly different definitions. Sullivan [24] has also derived a result similar to Equation (20) in which the mean temperature, cross-sectional area and mean flow in pipes 1 and 2 are different.

The transmission loss TL is convenient to predict but inconvenient to measure experimentally. With some care it is possible to construct an anechoic termination from an absorbently lined horn or absorbent packing [15,41] enabling $|p_2^+|$ to be measured directly. The quantity $|p_1^+|$ can also be determined when the source (in Figure 13) is a loudspeaker, by measuring the standing wave in the exhaust pipe, using a microphone probe tube (although it is a laborious process). However if the transmission loss is determined in the "real-life" situation with an automobile engine as a source, the microphone probe tube is placed under severe environmental conditions of high temperature and moisture condensation. Alternatively the transmission loss can be measured using

two microphones instead of a probe tube as suggested by Seybert and Ross [53]. However if a tail pipe anechoic termination is used it, must be of special design to withstand the high temperature. Of much more practical interest and much easier to measure with an engine as a source is the insertion loss which is discussed next.

B. Insertion Loss. Using Figure 13b again gives:

$$V_1 = V_e - P_1/Z_e, \quad (21)$$

$$V_2 = P_2/Z_r, \quad (22)$$

where Z_e and Z_r are the engine internal impedance and tail pipe radiation impedance, respectively. Then from Equation (11):

$$P_1 = AP_2 + BP_2/Z_r, \quad (23)$$

$$V_1 = CP_2 + DP_2/Z_r. \quad (24)$$

Substituting for V_1 from Equation (21) into Equation (24) and combining Equations (23) and (24) to eliminate p_1 gives:

$$P_2 = Z_e Z_r V_e / (AZ_r + B + CZ_e Z_r + DZ_e). \quad (25)$$

If a different muffler with four-terminal parameters A' , B' , C' and D' is now connected to the engine, a new pressure p_2' results:

$$P_2' = Z_e Z_r V_e / (A'Z_r + B' + C'Z_e Z_r + D'Z_e). \quad (26)$$

Thus

$$\frac{P_2'}{P_2} = \frac{AZ_r + B + CZ_e Z_r + DZ_e}{A'Z_r + B' + C'Z_e Z_r + D'Z_e} \quad (27)$$

This result is similar to that obtained by Sullivan [24]. If P_2' is measured with no muffler in place and only a short (in wavelengths) exhaust pipe, then $A' = D' = 1$, and $B' = C' = 0$. Then

$$\frac{P_2'}{P_2} = \frac{AZ_r + B + CZ_e Z_r + DZ_e}{Z_e + Z_r} \quad (28)$$

This result is similar to that obtained in [20]. Since $IL = 20 \log_{10} |P_2'/P_2|$ it is seen from either Equation (27) or (28) that unlike the TL, IL depends on both the internal impedance of the engine and the tail pipe radiation impedance, besides the transmission characteristics of the muffler itself. Several workers have predicted the insertion loss (IL) of mufflers installed on engines, e.g., Young [40] and Davies [55]. However they have normally had to rely on assumed values of engine impedance (e.g., $Z_e = 0$, $\rho c/S_0$ or ∞), since measured values have not become available until recently. Young's results for IL, [40], will be discussed later.

In prediction of insertion loss, Z_r must also be known. Discussion on the problems of estimating Z_e and Z_r follows in a later section.

If the engine and radiation impedances are assumed to be $Z_e = Z_r = \rho c/S_0$, then Equation (28) becomes:

$$\frac{P_2^i}{P_2} = \frac{\Lambda(\rho c/S_0) + B + C(\rho c/S_0)^2 + D(\rho c/S_0)}{2\rho c/S_0}, \quad (29)$$

and

$$IL = 20 \log_{10} |P_2^i/P_2|,$$

$$IL = 20 \log_{10} \{ |\Lambda + B(S_0/\rho c) + C/(S_0/\rho c) + D|/2 \}; \quad (30)$$

a result identical to Equation (20). This demonstrates the general case that the muffler transmission loss is not equal to the insertion loss except when the insertion loss is measured with source and termination impedances equal to the characteristic acoustic impedance $\rho c/S_0$. The same conclusion can be reached intuitively or theoretically (although it is more difficult than with transmission matrix theory) by studying the travelling wave solutions (transmission line theory) in mufflers and the exhaust and tail pipes.

C. Sound Pressure Radiated From Tail Pipe

A prediction of this quantity is of probably more importance to muffler designers than a knowledge of either transmission loss or insertion loss. After all, the radiated sound pressure level is the quantity which finally determines the acceptability of a muffler. Examining Equation (25), shows that if the engine volume velocity source strength V_e , engine impedance Z_e , radiation resistance Z_r and muffler four-terminal (fourpole) parameters A, B, C and D are known, then the total pressure amplitude (and phase)

at the end of the tail pipe p_2 can be calculated. It is a fairly simple matter to calculate the radiated pressure amplitude $|p_r|$ at distance r from the tail pipe outlet [33,34,36]. The method used is to assume monopole radiation from the tail pipe so that the net acoustic intensity transmitted out of the tail pipe is equal to the intensity in the diverging spherical wave at radius r . This gives:

$$2\pi a^2 (|p_2^\dagger|^2 / 2\rho_2 c_2) \{ (1+M)^2 - (1-M)^2 R^2(M) \} \\ \approx 4\pi r^2 |p_r|^2 / 2\rho_0 c_0 \quad (31)$$

where a is the tail pipe radius, and $R(M)$ the tail pipe reflection coefficient (dependent on Mach number) of the mean flow. Subscript 2 refers to conditions just inside the tail pipe. From Equations (2a) and (3c), at any station in the muffler:

$$2p^\dagger = p + (\rho c/S_0)V, \quad (32)$$

and at the tail pipe exit:

$$p_2 = V_2 Z_r. \quad (33)$$

Thus, at the tail pipe exit, from Equations (32) and (33):

$$p_2 = 2p_2^\dagger / [1 + (\rho c/S_0)/Z_r] \quad (34)$$

and substituting Equation (34) into (25) gives:

$$p_2^\dagger = V_a Z_a (Z_r + \rho c/B_0) / 2 [AZ_r + B + CZ_a Z_r + DZ_a]. \quad (35)$$

Taking the modulus of Equation (35) and substituting it into Equation (31) eliminates p_2^+ and gives the pressure $|p_r|$ in terms of the source volume velocity, V_e , the engine and tail pipe radiation impedances, Z_e and Z_r , the muffler fourpole parameters, the tail pipe reflection coefficient $R(M)$ and the mean-flow Mach number in the tail pipe, M .

TAIL PIPE RADIATION IMPEDANCE, ENGINE IMPEDANCE AND SOURCE STRENGTH

A. Tail Pipe Radiation

Early work on mufflers was hampered by a lack of knowledge of the reflection of waves at the end of the tail pipe. As Alfredson discusses [33], various assumptions have been made in the past about the magnitude and phase of the reflection (some workers assuming the reflection coefficient R was zero and some, one). In 1948, Levine and Schwinger [56] published a rigorous, lengthy theoretical derivation of the reflected wave from an unflanged circular pipe. The solution assumes plane wave propagation in the pipe and no mean flow. In 1970, Alfredson measured the reflection coefficient R and phase angle θ of waves in an engine tail pipe using the engine exhaust as the source signal. The motivation was to determine if a mean flow and an elevated temperature had a significant effect on the zero flow reflection coefficient and phase calculated by Levine and Schwinger. Both the theoretical results of Levine and Schwinger and Alfredson's experimental results are given in Figure 14.

Alfredson's experimental results show only a 3 to 5 percentage increase in the reflection coefficient and virtually no change in the phase angle, as the flow and temperature increase to those conditions found in a typical engine tail pipe. Either Alfredson's or Levine and Schwinger's results for R and θ can be used to determine the tail pipe radiation impedance Z_r used in insertion loss or sound pressure predictions [Equations (27) and (28) or (25) and (35)].

The ratio of the pressure and volume velocity at the tail pipe exit yields the radiation impedance Z_r :

$$\begin{aligned}
 p_2 &= p_2^+ + p_2^- = p_2^+(1 + Re^{i\theta}), \\
 v_2 &= (S_0/\rho_2 c_2)(p_2^+ - p_2^-) = p_2^+(S_0/\rho_2 c_2)(1 - Re^{i\theta}), \\
 \therefore Z_r &= p_2/v_2 = (\rho_2 c_2/S_0)(1 + Re^{i\theta})/(1 - Re^{i\theta}). \quad (36)
 \end{aligned}$$

B. Engine Impedance and Source Strength

Until recently, values of engine impedance have been completely speculative. Values of Z_e of 0, $\rho c/S$ and ∞ have been assumed by various workers in making insertion loss calculations. Other experimenters have tried to simulate these different values in their idealized experimental arrangements. Values of $Z_e = \infty$ and 0, correspond to constant volume velocity (current) and constant pressure (voltage) sources, respectively. Suppose the muffler and termination impedances shown in Figure 13 are lumped together as a load impedance, then Figures 13b and 13c reduce to Figures 15a and 15b respectively.

For the volume velocity source, $V_1 = V_c Z_c / (Z_c + Z_l)$ and if the internal impedance $Z_c \rightarrow \infty$, $V_1 \rightarrow V_c$. A constant volume velocity is supplied to the load, independent of its impedance value, (provided it remains finite). When $Z_c \rightarrow \infty$, this source is known as a constant volume velocity source. For the pressure source, $p_1 = p_c Z_l / (Z_c + Z_l)$ and if the internal impedance $Z_c \rightarrow 0$, $p_1 \rightarrow p_c$. A constant acoustic pressure is supplied to the load terminals independent of of the impedance value (provided it remains finite also). When $Z_c \rightarrow 0$ this source is known as a constant pressure source. Note that if $Z_c = \rho c/S$ in either model, that constant sources are not obtained in either model. These constant volume velocity and constant pressure sources are equivalent to constant current and voltage sources which are well known in electrical circuits (see, e.g., [57]).

It is of course unlikely that engine impedance approximates either 0, $\rho c/S$ or ∞ . However, it could approach one of these values in certain frequency ranges. Some have even questioned the meaning of engine impedance since it must vary with time as exhaust ports close and open. There are at least three approaches to model the engine source characteristics. Without directly using the concept of engine impedance as such, Mutyala and Soedel [58,59], working at the Herrick Laboratories, have used a mathematical model of a single-cylinder two-stroke engine connected to a simple expansion chamber muffler. The passages and volumes are treated as lumped parameters

and kinematic, thermodynamic and mass balance equations are used. Good agreement between theory and experiment was obtained for the radiated exhaust noise.

Galitsis and Bender [60] have used an empirical approach to measure engine impedance directly. Using an electromagnetic pure tone source and by measuring standing waves in an impedance tube connected to a running engine they were able to determine the engine internal impedance. At low RPM the impedance fluctuated. However, at high RPM the impedance approached $\rho c/S$ at higher frequency. Ross [61] has also used a similar technique.

A third approach to the determination of engine impedance (and source strength) is the two load method. This method is well known in electricity but has been little tried in acoustics. Kathuriya and Munjal [54] have recently discussed this method theoretically but apparently have yet to try it in practice.

Using the pressure source representation [54] (see Figure 15b) and two different known loads Z_R and Z_R' , two simultaneous equations are obtained:

$$P_1 = P_0 Z_R / (Z_0 + Z_R), \quad (37)$$

$$P_1' = P_0 Z_R' / (Z_0 + Z_R'). \quad (38)$$

Eliminating P_0 in Equations (37) and (38) gives:

$$Z_0 = (P_1 - P_1') / (P_1'/Z_R' - P_1/Z_R). \quad (39)$$

RECT AVIEN ARI E 0000

Substitution of Z_c in Equation (37) or (38) now gives the source strength p_c . Kathuriya and Munjal suggest using two different length pipes so that there is little change in back pressure and so that (presumably) the load impedances, Z_L and Z_L' (comprised of straight pipe and radiation impedance) are well known. In order to remove the necessity to measure p_1 inside the tail pipe (where the exhaust gas is hot) it should be possible to measure the sound pressure radiated from the tail pipe p_r since this can be related to the pressure p_1 in the straight pipe by equations such as (31) and (34).

Egolf [62] has used this two load method in the design of a hearing aid. Sullivan [24] discusses the limitations of the method.

RESEARCH WORK ON MUFFLER DESIGN AT HERRICK LABORATORIES

A program of research on the acoustic performance of automobile mufflers has been conducted at Herrick Laboratories since 1970.

Finite Element Analysis

Young and Crocker [38,39,40,41,42] were the first to use finite element analysis in muffler design. So far in this paper it has been assumed that acoustic filter theory [13,14] provides a sufficient theoretical explanation for the behavior of muffler elements. This filter theory is normally based on the plane wave assumption. However when a certain frequency limit is reached (known as the cut-off

frequency), the filter ceases to behave according to plane wave theory. (This cut-off frequency is usually proportional to the pipe or chamber diameter.) In addition, if the muffler element shape is complicated, the simple plane wave assumptions and the boundary conditions are difficult to apply.

In Young and Crocker's work a numerical method was produced to predict the transmission loss of complicated shaped muffler elements. In this approach, variational methods were used to formulate the problem instead of the wave equation. The theoretical approach is described in detail in [38-42] and will not be given in detail here. It is assumed that the muffler element is composed of a volume V of perfect gas with a surface area S . The surface S is composed of two parts: one area over which the normal acoustic displacement is prescribed and the other area over which the pressure is prescribed. The pressure field in the muffler element is solved by making the Lagrangian function stationary [38]. Thus this approach is essentially an approximate energy approach. The muffler element is divided into a number of subregions (finite elements). At the corners of the elements the acoustic pressure and volume velocity are determined. The four pole parameters A , B , C and D relating the pressure and volume velocity before and after the muffler element are obtained in a similar manner to that described above assuming that the matrix output terminals are alternately open-circuited or short-circuited [38].

At the corners of the elements the acoustic pressure and volume velocity are determined. The four pole parameters A, B, C, D relating the pressure and volume velocity before and after the muffler element are obtained in a similar manner to that described above assuming that the matrix output terminals are alternately open-circuited or short-circuited [38].

In order to check the finite element approach and computer program, it was first applied to the classical expansion chamber case [40]. The dimensions of the simple expansion chamber used are given in Figure 16a. The chamber was 8 inches (0.20 m) long and 10 inches (0.25 m) in diameter. Since the chamber was symmetrical, only half the chamber was represented with finite elements. Three finite element models were studied. The first had 8 elements with 16 nodal points, the second had 16 elements with 28 nodal points (see Figure 16b). The third had 24 elements with 38 nodal points.

Figure 17 shows the transmission loss predicted by the three finite element models and by the classical theory for an expansion chamber (see Equation (4)). Figure 17 shows the rapid convergence of the finite element approximation. Eight elements are insufficient to predict the transmission loss (TL), although the TL predicted by 16 or 24 elements is about the same. Note, however, that above about 1100 Hz, the classical theory and the

REST AVIATION AND SPACE

finite element TL predictions diverge. Above this frequency the chamber-diameter-to-wavelength-ratio becomes less than 0.8 and higher modes, in addition to plane waves, can exist in the expansion chamber. However, the classical theory (Equation (4)) only predicts the plane wave performance.

Having shown that the finite element program could be used to predict transmission loss successfully on known chambers, it was now used to examine chambers such as reversing flow end chambers (see Figure 3), end chamber Helmholtz resonator combinations and finally mufflers comprised of combinations of straight pipes, end chambers and up to two Helmholtz resonators.

A typical end chamber examined is shown in Figure 18. The measurement of transmission loss was based on the standing wave method, see Figure 19. An acoustic driver (H) was used to supply a pure tone signal and the standing wave in the test section (J) was measured with the microphone probe tube (I). Using standing wave theory the amplitude of the incident wave was determined by measuring the maxima and minima of the standing wave at different frequencies. The transmitted wave was determined by a single microphone (M) since the reflections were minimized by the anechoic termination (L). A steady mean air flow could be supplied to the plenum chamber (G) and was used to investigate flow effects on transmission loss in some experiments.

Figures 20 and 21 show the predicted and measured transmission loss of two different shape reversing end chambers, with and without a mean air flow of 110 ft/sec (33.5 m/s). Neither end chamber examined had a pass tube. The first chamber has side-in side-out (SI-SO) tubes and the second side-in center-out (SI-CO) tubes. It is observed that experimental agreement with theory is good and that flow effects appear small at the mean flow velocity (Mach number) used. Part of the volume appeared to act as a side-branch with the SI-CO chamber (Figure 21). The theory developed was then used to conduct a theoretical parametric study on reversing end chambers as dimensions, and locations of inlet, outlet and pass tubes were changed. The results are given in [41].

Figures 22 and 23 show the predicted and measured transmission loss of similar SI-SO and SI-CO end chambers both of which have pass tubes. Both the cases when the end chambers have Helmholtz resonators attached (solid line) and when there are no resonators (broken line) are shown. The no-resonator cases are similar to Figures 20 and 21, except that here pass tubes are present. It should be noted that the experimental points were measured without flow but with resonators attached. The predictions were made by dividing both the end chamber and the resonator into finite elements [41]. Although only two-dimensional finite elements were used, the third dimension and the elliptical cross-

sectional shape were allowed for by varying the mass of the elements corresponding to their thickness [38-42]. It is noted in Figures 22 and 23 that the addition of the Helmholtz resonators produces sharp attenuation peaks in the transmission loss curves. The first resonance frequency peak at 350 Hz agrees well with the value of 356 Hz calculated for the resonance frequency of a Helmholtz resonator using lumped parameter (mass-spring) theory [42]. The higher frequency peak must be produced by a higher mode resonance caused by interactions between the Helmholtz resonators and the end chambers.

Figure 24 shows that the positioning of the resonator neck is theoretically an important factor in determining the transmission loss curve [42].

Figures 25, 26 and 27 show the predicted and measured transmission loss for three different muffler combinations. The predictions were made by combining the predicted four pole parameters of the end chamber systems with those of the straight pipes using the matrix multiplication method discussed earlier (see Equation (13)). The muffler combinations shown in Figures 25, 26 and 27 are typical of automobile reverse flow mufflers used in the USA except that cross flow elements and side branch concentric resonators are absent. It was shown that at least at the low Mach number used (flow velocity of 32 m/s) that there was very little difference in the

transmission loss measured with or without flow. Flow effects may be more important at higher flow rates (corresponding to higher engine loads). Also flow is expected to have a greater effect on the radiated sound (see Equation (1) and Figure 5).

PREDICTION OF CONCENTRIC TUBE SIDE BRANCH RESONATORS

Sullivan and Crocker [46,47] have examined the transmission loss of concentric tube resonators (sometimes known as "split chambers" or "bean cans", (See Figure 3). These resonators which are often used to provide higher frequency attenuation are constructed by placing a rigid cylindrical shell around a length of perforated tube, thus forming an unpartitioned cavity. Sullivan and Crocker used a one-dimensional control volume approach to derive a theoretical model which accounted for the longitudinal wave motion in the cavity and the coupling between the cavity and the tube via the impedance of the perforate.

Figures 28 and 29 show the transmission loss for both short and long resonators [46,47]. In short resonators the primary resonance frequency f_r is less than the first axial modal frequency f_1 of the cavity, ($f_1 = c/2l$) where c is the speed of sound and l the length. If $f_r > f_1$, then the cavity is said to be long. The transmission loss of short resonators (Figure 28) is characterized by two peaks. The first resonance peak results from the

coupling of the center tube with the concentric cavity and its frequency f_r can be calculated approximately from the branch Helmholtz equation [46,47]. However in Figure 28, the Helmholtz frequency f_o is less than the fundamental frequency f_r by 27%. The frequency of the second peak in Figure 28 is related but not equal to the first axial cavity modal frequency $f_1 = c/2l$.

The performance of concentric tube resonators is dependent on the parameter $k_o l$ where $k_o = 2\pi f_o/c = \sqrt{C/V}$. Here k_o is the wave number of the Helmholtz resonance frequency f_o , c is the speed of sound, and C , V and l are the conductivity, volume and axial length of the resonator respectively.

In Figure 29 the transmission loss of a long resonator is shown. Here the primary resonance frequency f_r occurs above the first and several other cavity longitudinal standing wave modal frequencies. Figure 30 shows the theoretical effect of changing the porosity of a resonator of constant length 66.7 mm so that as the porosity is increased from 0.5% to 5.0%, the primary resonance frequency f_r and the first axial modal frequency f_1 are gradually merged to provide a wide band of high transmission loss [46,47].

INSERTION LOSS

The effect of source impedance on insertion loss was investigated theoretically by Young [39]. Some results

are shown in Figures 31 and 32. In Figure 31 it is seen that there is a large difference between insertion loss curves for a muffler for the three different source impedances investigated: $Z_1 = 0$, $\rho c/S$, and ∞ , when the prediction is made for discrete frequencies. However Figure 32 shows that if the insertion loss is averaged on an energy basis (with a theoretical 25 Hz filter) that the differences in insertion loss predictions are much less. Note that the vertical scales in Figures 31 and 32 are different and that a different engine firing frequency is chosen. Also of considerable interest is the fact that in both figures the transmission loss curve passes through the middle of the insertion loss curves. In Figure 32, the hills and valleys in the insertion loss curves are thought to be caused by standing waves in the lengths of straight (exhaust and tail) pipes in the muffler systems.

CONCLUSIONS

This paper has reviewed briefly the historical development of theory to predict the acoustic performance of mufflers (silencers) used on internal combustion engines. Research conducted at Herrick Laboratories has been reviewed in a little more detail.

It seems that theory has now been developed which can predict fairly accurately the transmission loss (TL) of mufflers particularly when loudspeaker (or acoustic

driver) type sources are used. It is more difficult to predict the transmission loss of a muffler when it is installed on an engine and high mean flow rates and severe temperature gradients exist in the muffler.

It was shown theoretically that if it is desired to predict the insertion loss of a muffler, then it is necessary to know the source (engine) and radiation impedance. Although the radiation impedance of a tail pipe has been known theoretically for some time [56], the impedance of engines has only recently been measured [60,61]. However Young has shown theoretically [39] that source (engine) impedance becomes less important, provided narrow band predictions of insertion loss, IL, are not required and some frequency averaging can be tolerated.

It would seem that for the purposes of a quick bench test to compare the transmission loss and/or insertion loss of different mufflers, an acoustic driver source could be used. However, in this case, flow effects and temperature gradient effects would be lost. These, however, may be less important in transmission loss predictions than in insertion loss predictions. Flow effects could be included by supplying a mean flow through the muffler from a fan or blower source. Insertion loss could be measured with such an experimental set-up provided narrow band results are not required.

Because flow, temperature gradient (and engine impedance) effects are known to be important in muffler acoustic performance, the only real way to test a muffler is on a real engine. Thus a "standard" engine could be used and insertion loss of different mufflers measured with it and compared with each other. The comparisons between mufflers should be applicable to other engines provided the mean flow is not vastly different and provided some frequency averaging is used. In any case it may be almost as easy to use an engine as a source, than to try to make an artificial source from an acoustic driver and fan or blower combination.

ACKNOWLEDGMENTS

This paper is based in part on a paper which appeared in the NOISE-CON 77 Proceedings and on results presented previously in some other papers. However, some sections of the paper are new. Much of the research work conducted at Herrick Laboratories which was described in this paper was funded by contracts from Arvin Industries, Columbus, Indiana.

REFERENCES

1. M.J. Crocker, Mufflers, in Tutorial Papers on Noise Control, Edited by M.J. Crocker, INTER-NOISE 72, pp. 40-44. Also published in Reduction of Machinery Noise (Rev. Ed.), edited by M.J. Crocker, Purdue University, 1975, pp. 112-116.
2. I. Dyer, "Noise Attenuation of Dissipative Mufflers," Noise Control, 2, 3, 1956, pp. 50-57.
3. G.J. Sanders, "Silencers: Their Design and Application," Sound and Vibration, February 1968, pp. 6-13.
4. C.E. Nelson, "Truck Muffler Design," Noise Control, 2, 3, 1956, pp. 24-27 and 77.
5. M.J. Crocker, "Internal Combustion Engine Exhaust Muffling," NOISE-CON 77 Proceedings, October 17-19, 1977, pp. 331-358.
6. P.A. Franken, "Reactive Mufflers," Chapter 16 in Noise Reduction, L.L. Beranek (Editor), McGraw-Hill Book Co., New York, 1960.
7. N. Doelling, "Dissipative Mufflers," Chapter 17 in Noise Reduction, L.L. Beranek (Editor), McGraw-Hill Book Co., New York, 1960.
8. T.F.W. Embleton, "Mufflers," Chapter 12 in Noise and Vibration Control, L.L. Beranek (Editor), McGraw-Hill Book Co., New York, 1971.
9. G.W. Stewart, "Acoustic Wave Filters," Phys. Review, 20, 1922, p. 528. See also G.W. Stewart, Phys. Review, 23, 1924, pp. 520, and G.W. Stewart, Phys. Review, 25, 1925, pp. 90.
10. W.P. Mason, Bell Sys. Tech. Journal, 6, 1927, pp. 258.
11. A.W. Morley, Progress in Experiments in Aero-Engine Exhaust Silencing, R&M No. 1760, British A.R.C., 1937.

12. H. Martin, V. Schmidt and W. Willins, The Present Stage of Development of Exhaust Silencers, RTP TIB Translation No. 2596, British Ministry of Aircraft Production (from MPZ, No. 12, 1940).
13. D.D. Davis, Jr., G.M. Stokes, D. Moore and G.L. Stevens, Jr., "Theoretical and Experimental Investigation of Mufflers with Comments on Engine Exhaust Muffler Design," NACA 1192, 1954.
14. D.D. Davis, Jr., "Acoustical Filters and Mufflers," Chapter 21 in Handbook of Noise Control, C.M. Harris (Editor), McGraw-Hill Book Co., New York, 1957.
15. J. Igarashi and M. Toyama, Fundamental of Acoustical Silencers (I), Report No. 339, Aeronautical Research Institute, University of Tokyo, December 1958, pp. 223-241.
16. T. Miwa and J. Igarashi, Fundamentals of Acoustical Silencers (II), Report No. 344, Aeronautical Research Institute, University of Tokyo, May 1959, pp. 67-85.
17. J. Igarashi and M. Arai, Fundamentals of Acoustical Silencers, (III), Report No. 351, Aeronautical Research Institute, University of Tokyo, February 1960, pp. 17-31.
18. T.L. Parrott, "An Improved Method for Design of Expansion-Chamber Mufflers with Application to an Operational Helicopter," NASA TN D-7309.
19. K.U. Ingard (unpublished information) as reported in Chapter 21, Handbook of Noise Control, C.M. Harris (Editor), McGraw-Hill Book Co., New York, 1957 (see Figure 21.47).
20. E.K. Bender and A.J. Brammer, "Internal Combustion Engine Intake and Exhaust System Noise," J. Acoust. Soc. Am., 58, 1, 1975.
21. M. Fukuda, A Study on the Exhaust Muffler of Internal Combustion Engines, Bulletin of JSME, 6, 22, 1963, pp. 255-269.
22. M. Fukuda, A Study on Characteristics of Cavity-Type Mufflers, (1st Report), Bulletin of JSME, 12, 50, 1969, pp. 333-349.
23. M. Fukuda and J. Okuda, A Study on Characteristics of Cavity-Type Mufflers (2nd Report) Bulletins of JSME, 13, 55, 1970, pp. 96-104.

24. J.W. Sullivan, Modelling of Engine Exhaust System Noise, paper to be presented at ASME Winter Conference, Atlanta, Georgia, November 1977.
25. P.O.A.L. Davies, "The Design of Silencers for Internal Combustion Engine," Jour. Sound and Vib. 1, 2, 1964, pp. 185-201.
26. P.O.A.L. Davies and M.J. Dwyer, A Simple Theory for Pressure Pulses in Pipes, Proc. Inst. Mech. Eng., London, 1963.
27. G.P. Blair and J.R. Goulbourn, Pressure-Time History in the Exhaust System of a High Speed Reciprocating Internal Combustion Engine, SAE Transactions, 76, paper 670477, 1967.
28. R.S. Benson and J.S. Foxcroft, Nonsteady Flow in Internal Combustion Engine Inlet and Exhaust Systems, Inst. Mech. Eng. (London), paper no. 3, 1970, pp. 2-26.
29. G.P. Blair and J.A. Spechko, Sound Pressure Levels Generated by Internal Combustion Engine Exhaust Systems, SAE Paper 720155, 1972.
30. G.P. Blair and S.W. Coates, Noise Produced by Unsteady Exhaust Efflux from an Internal Combustion Engine, SAE Transactions, 82, paper 730160, 1973.
31. S.W. Coates, The Prediction of Exhaust Noise Characteristics of Internal Combustion Engines, Ph.D. Thesis, Queen's University of Belfast, Northern Ireland, April 1974.
32. S.W. Coates and G.P. Blair, Further Studies of Noise Characteristics of Internal Combustion Engine Exhaust Systems, SAE Paper 740713, 1974.
33. R.J. Alfredson and P.O.A.L. Davies, "The Radiation of Sound from an Engine Exhaust," Jour. Sound and Vib., 13, 4, 1970, pp. 389-408.
34. R.J. Alfredson, The Design and Optimization of Exhaust Silencers, Ph.D. Thesis, University of Southampton, 1970.
35. R.J. Alfredson and P.O.A.L. Davies, "Performance of Exhaust Silencer Components," Jour. Sound and Vib., 15, 2, 1971, pp. 175-196.
36. R.J. Alfredson, The Design of Exhaust Mufflers Using Linearized Theoretical Models, SAE Paper 719139, pp. 1048-1052.

37. P.O.A.L. Davies and R.J. Alfredson, Design of Silencers for Internal Combustion Engine Exhaust Systems, Proc. J. Mech. E., Conference Vibration and Noise in Motor Vehicles, pp. 17-23.
38. C.-I. J. Young and M.J. Crocker, Muffler Analysis by Finite Element Method, Ray W. Herrick Laboratories, Purdue University Report No. HL 71-33, December 1971.
39. C.-I. J. Young, Acoustic Analysis of Mufflers for Engine Exhaust Systems, Ph.D. Thesis, Purdue University, August 1973.
40. C.-I. J. Young and M.J. Crocker, "Prediction of Transmission Loss in Mufflers by the Finite-Element Method," Acoust. Soc. Am., 57, 1, 1975, pp. 144-148.
41. C.-I. J. Young and M.J. Crocker, "Acoustical Analysis, Testing, and Design of Flow-Reversing Muffler Chambers," Acoust. Soc. Am., 60, 5, 1976, pp. 1111-1118.
42. C.-I. J. Young and M.J. Crocker, Finite-Element Acoustical Analysis of Complex Muffler Systems With and Without Wall Vibrations, NOISE CONTROL ENGINEERING, 1977, 9, 2, pp. 86-93.
43. Y. Kagawa and T. Omote, "Finite-Element Simulation of Acoustic Filters of Arbitrary Profile with Circular Cross Section," Jour. Acoust. Soc. Am., 1976, 60, 5, pp. 1003-1013.
44. A. Craggs, "A Finite Element Method for Damped Acoustic Systems: An Application to Evaluate the Performance of Reactive Mufflers," Journ. Sound and Vib., 48, 3, 1976, pp. 377-392.
45. S.F. Ling, A Finite Element Method for Duct Acoustics Problems, Ph.D. Thesis, Purdue University, August 1976.
46. J.W. Sullivan, Theory and Methods for Modelling Acoustically-Long, Unpartitioned Cavity Resonators for Engine Exhaust Systems, Ph.D. Thesis, Purdue University, December 1974.
47. J.W. Sullivan and M.J. Crocker, "A Mathematical Model for Concentric Tube Resonators," submitted to J. Acoust. Soc. Am. for publication, May 1977.
48. D. Karnopp, "Lumped Parameter Models of Acoustic Filters Using Normal Modes and Bond Graphs," J. Sound Vib., 42, 4, 1975, pp. 437-446.

49. D. Karnopp et al, "Computer-Aided Design of Acoustic Filters Using Bond Graphs," NOISE CONTROL ENGINEERING, 1975 4, 3, pp. 114-118.
50. F.R. Fricke and M.J. Crocker, Sound Amplification in Expansion Chambers, Inter-Noise 75.
51. Y. Kirata and T. Itow, "Influence of Air Flow on the Attenuation Characteristics of Resonator Type Mufflers," Acustica, 28, 1973, pp. 115-120.
52. J.S. Anderson, "The Effect of an Air Flow on a Single Side Branch Helmholtz Resonator in a Circular Duct," J. Sound Vib., 52, 3, 1977, pp. 423-431.
53. A.F. Seybert and D.F. Ross, "Experimental Determination of Acoustic Properties Using a Two-Microphone Random-Excitation Technique," Jour. Acoust. Soc. Am., 61, 5, 1977, pp. 1362-1370.
54. M.L. Kathuriya and M.L. Munjal, A Method for the Experimental Evaluation of the Acoustic Characteristics of an Engine Exhaust System in the Presence of Mean Flow. J. Acoust. Soc. Am., 60, 3, 1976, pp. 745-751.
55. P.O.A.L. Davies, Exhaust System Silencing the Institution of Marine Engineers, 1972, pp. 46-51.
56. M. Levine and J. Schwinger, "On the Radiation of Sound from an Unflanged Circular Pipe," Physical Review, 73, 4, 1948, pp. 383-406.
57. H.H. Skilling, Electrical Engineering Circuits, John Wiley and Sons, Inc., New York, 1957, pp. 23-24.
58. B.R.C. Mutyala, A Mathematical Model of Helmholtz Resonator Type Gas Oscillation Discharges of Two-Cycle Engines," Ph.D. Thesis, Purdue University, December 1975.
59. B.R.C. Mutyala and W. Soedel, "A Mathematical Model of Helmholtz Resonator Type Gas Oscillation Discharges of Two-Stroke Cycle Engines," Journ. Sound and Vib., 41, 4, 1976, pp. 479-491.
60. A.G. Galatisis and E.K. Bender, "Measurement of the Acoustic Impedance of an Internal Combustion Engine," Jour. Acoust. Soc. Am., 58 (Supplement No. 1), Fall 1975.

BEST AVAILABLE COPY

61. D. Ross, Experimental Determination of the Normal Specific Acoustic Impedance of an Internal Combustion Engine, Ph.D. Thesis, Purdue University, 1976 (unpublished).
62. D.P. Egolf, A Mathematical Scheme for Predicting the Electro-Acoustic Frequency Response of Hearing Aid Receivers - Earmold - Ear Systems, Ph.D. Thesis, Purdue University, August 1976.

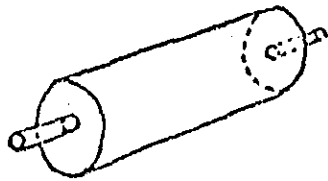

Figure 1a. Single Expansion Chamber

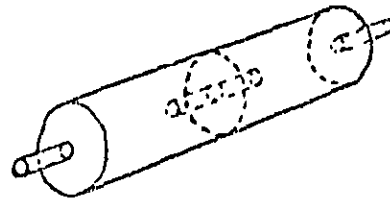

Figure 1b. Double Expansion Chamber With Internal Connecting Tubes

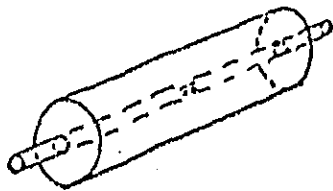

Figure 1c. Single Chamber Resonator

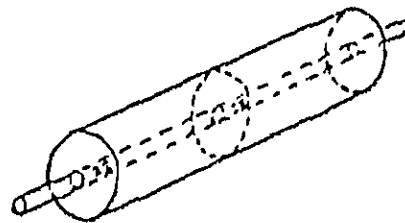

Figure 1d. Double Chamber Resonator

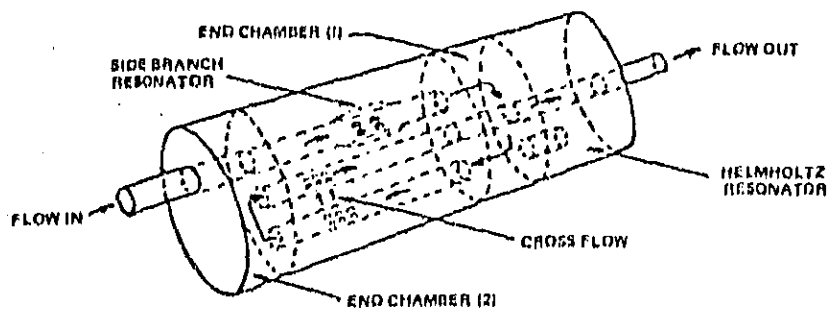

Figure 2. Typical Reverse-Flow Automobile Muffler

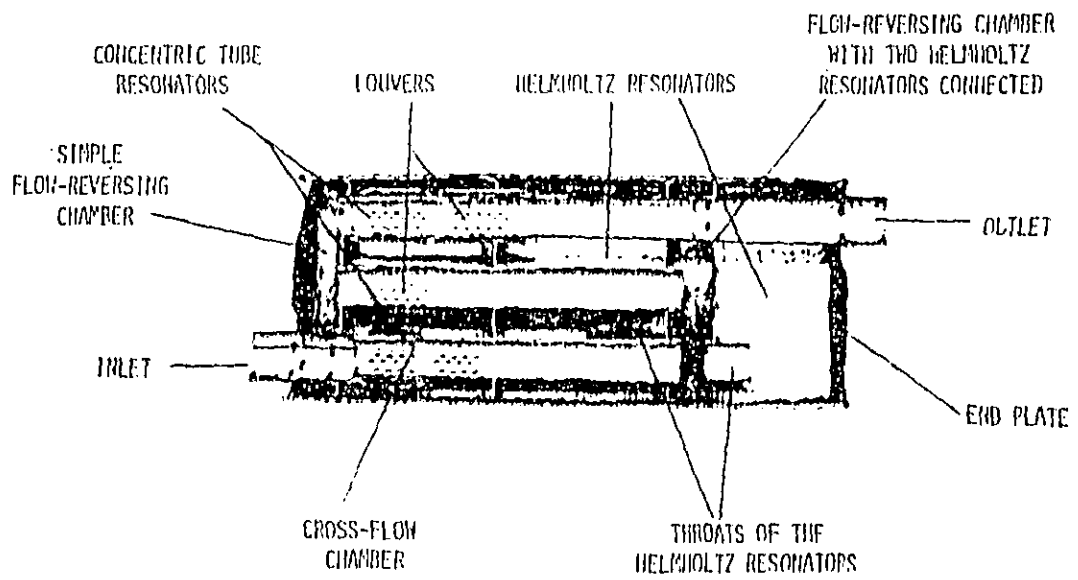

Figure 3 - Photograph showing cross section of common US reverse - flow automobile muffler with different parts indicated

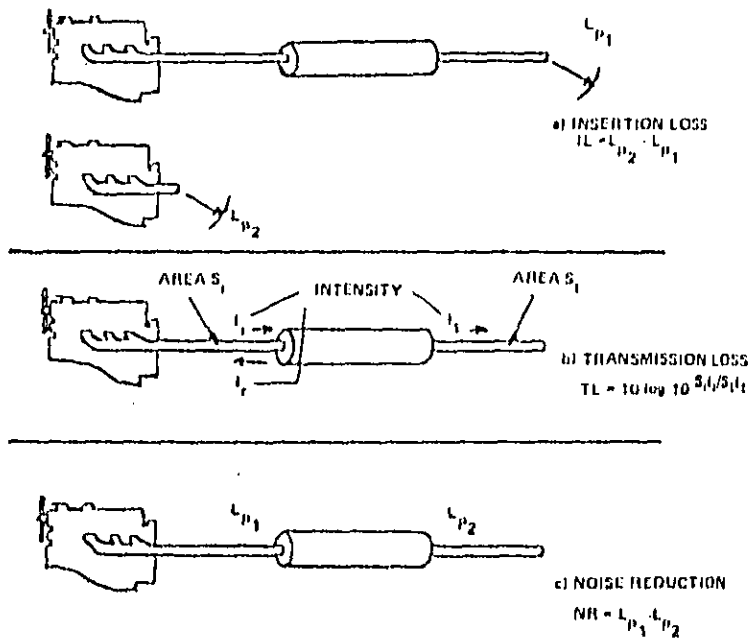

Figure 4. Definitions of Muffler Performance

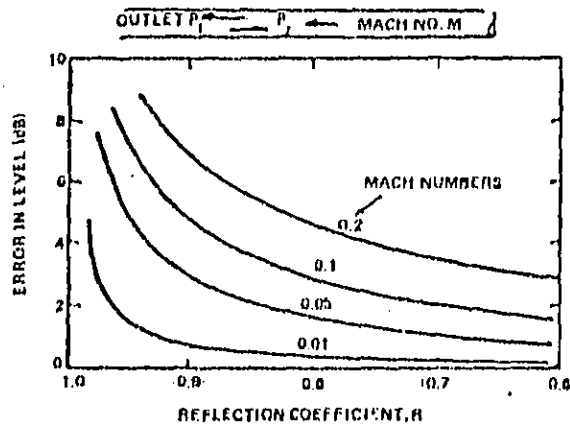

Figure 5. Radiated Sound Pressure Level Error Due to Neglect of Mean Flow, $P_r = R \cdot P_a^{10}$. Radiated Sound Pressure Level Calculated Neglecting Mean Flow is Low by the Amount Given Here as Error

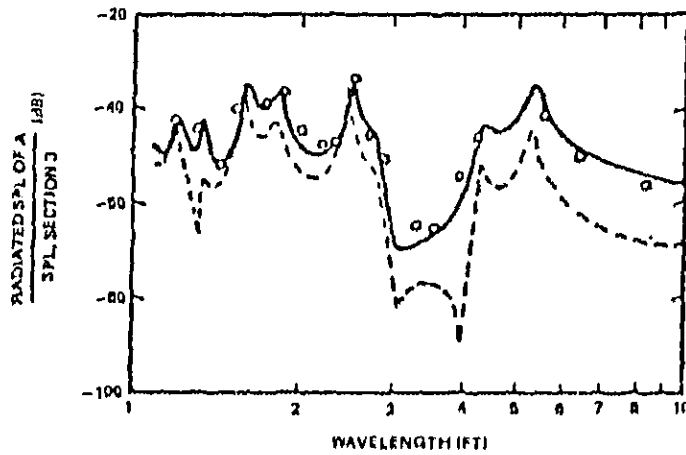
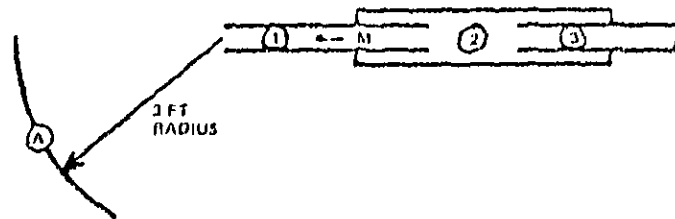

Figure 6. Influence of Mean Gas Flow on Effectiveness of Silencer. o, Measured values; —, Calculated, $M = 0.15$; - - - -, Calculated, $M = 0.0$.

DEPT AVIATION AND SPACE

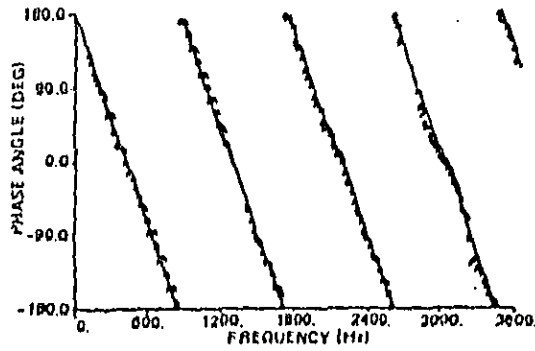
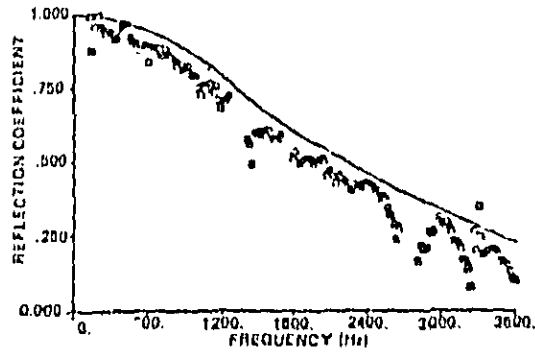

Figure 7. Power Reflection Coefficient and Phase Angle for Open End Tube. Solid Line: Theory; Open Square, Open Triangle: experiment.

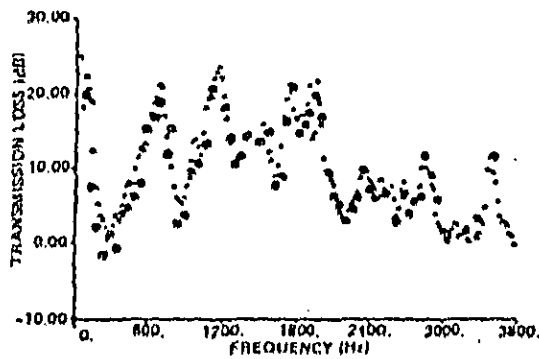

Figure 8. Measured Values of Transmission Loss for Prototype Automotive Muffler. Filled Circle: SWR Method; Open Square, Plus Sign: Two-Microphone Random-Excitation Method

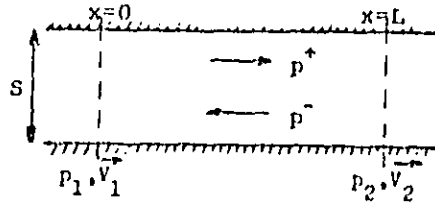

Figure 9. Muffler Element

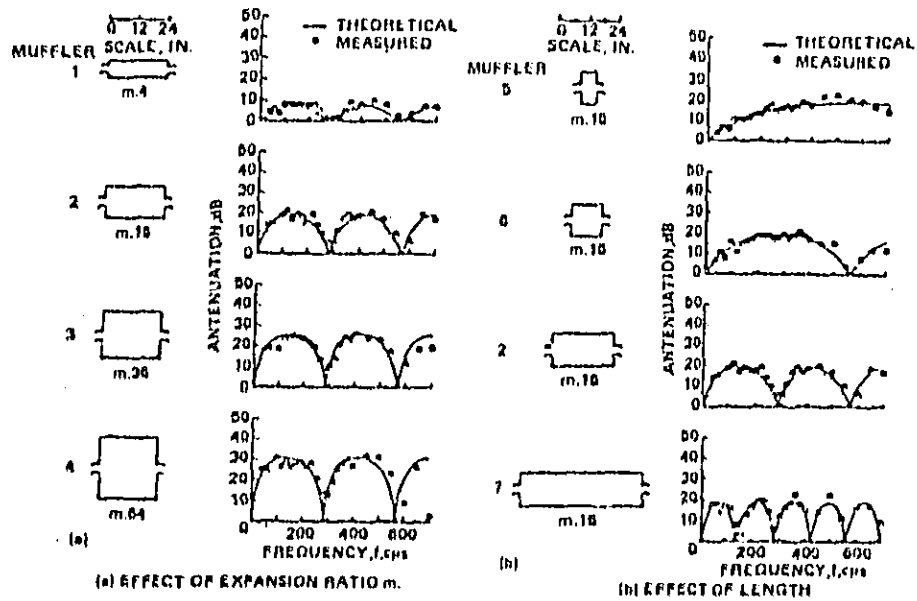

Figure 10. Comparison of Theoretical and Experimental Attenuation Characteristics — Single-Expansion-Chamber Mufflers; M is Tube Area Expansion Ratio

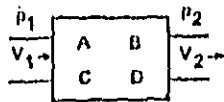

Figure 11. Four Pole Representation of Muffler Element

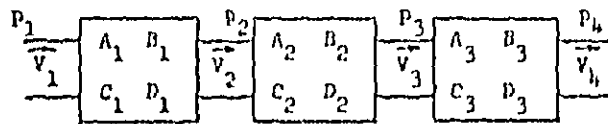

Figure 12. Series Connection of Transmission Matrices

Figure 13a. Real Engine-Muffler-Exhaust System

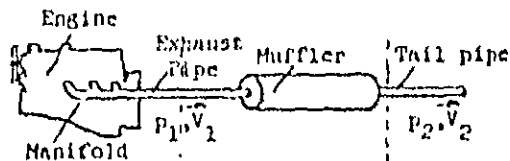

Figure 13b. Volume Velocity Analog

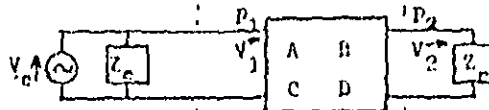
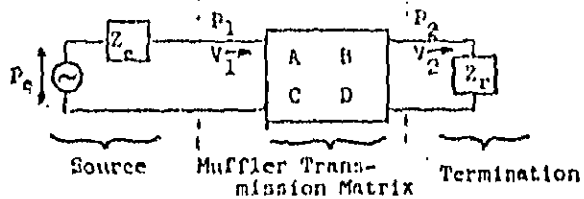

Figure 13c. Pressure Source Analog



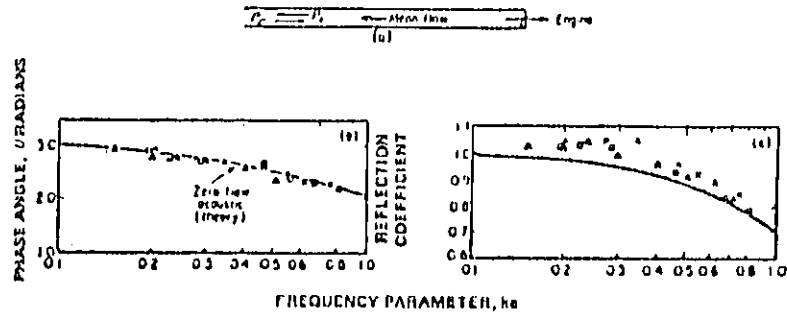

Figure 14. Reflection of Sound. (a) Exhaust Tail Pipe, $P_2 = P_1 e^{i\theta}$. (b) Phase Angles vs. Frequency Parameter. (c) Reflection Coefficient Vs. Reflection Parameter. —, Theoretical Zero Flow Acoustic; Δ , $M = 0.078$; \circ , $M = 0.11$; \times , $M = 0.17$.

Figure 15a. Volume Velocity Source

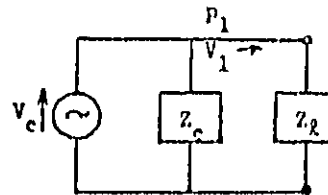
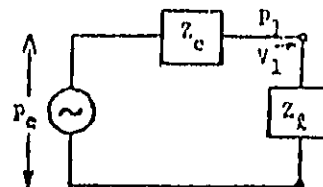

Figure 15b. Pressure Source



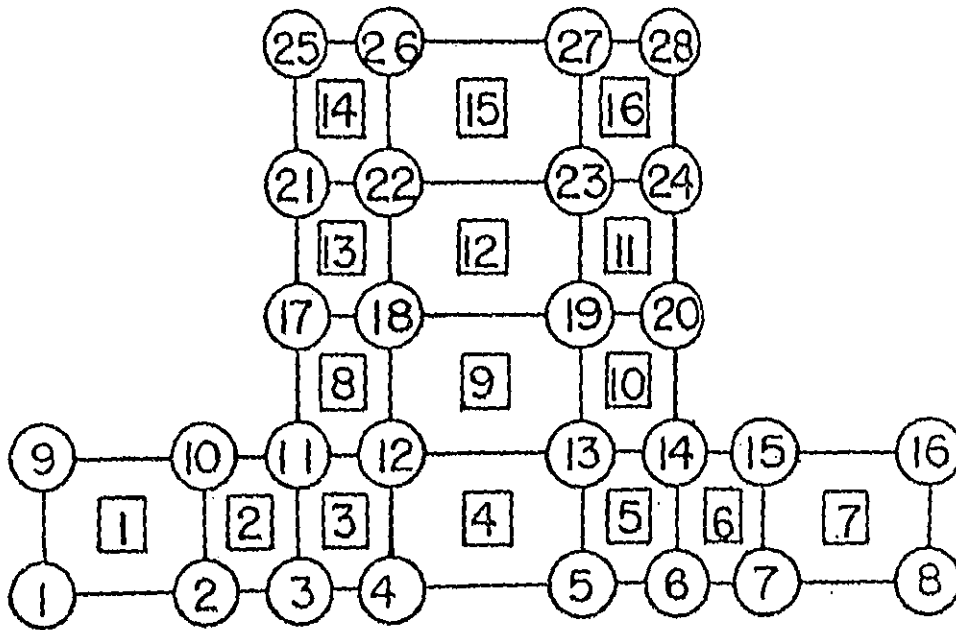
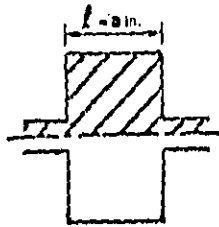

Figure 18. Simple Expansion Chamber Showing Division Into 10 Finite Elements and 20 Node Points

BEST AVAILABLE COPY

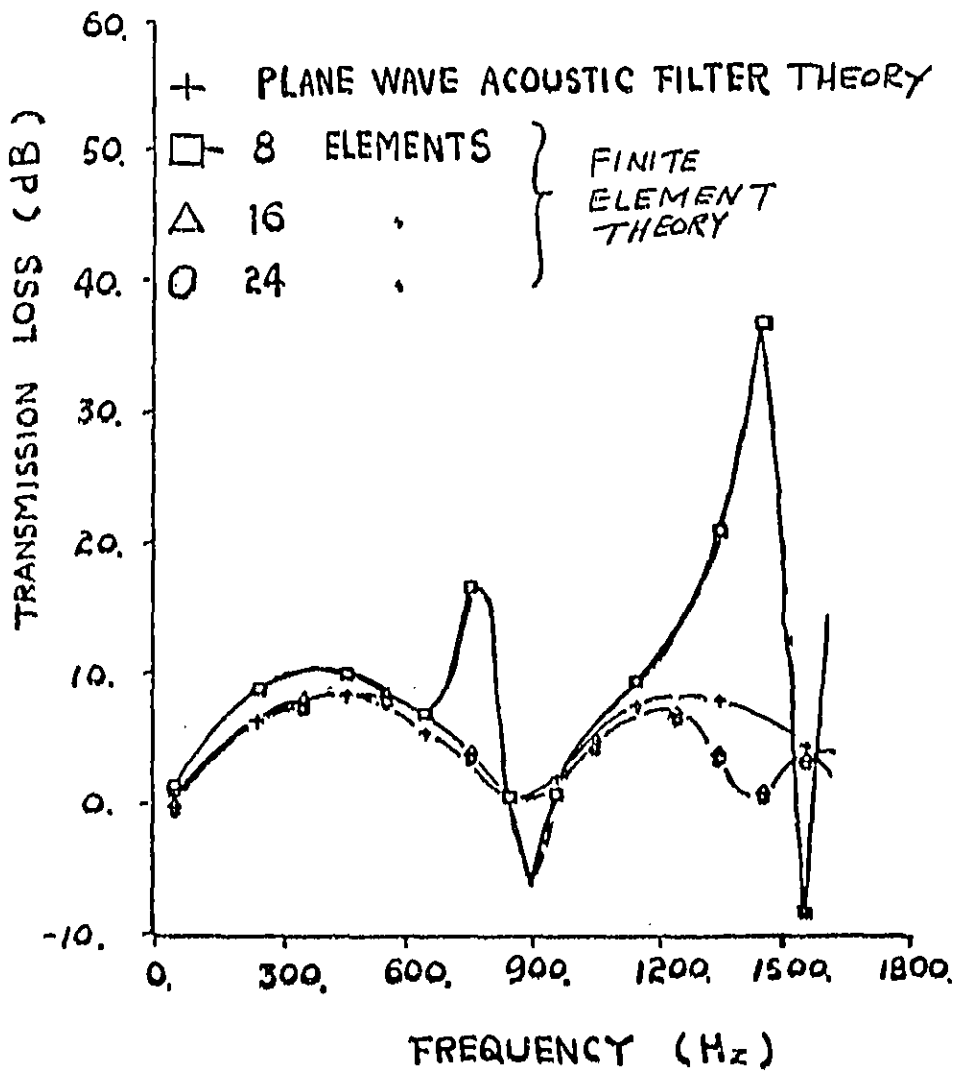

Figure 17. Transmission Loss of Simple Expansion Chamber, $R = 8.0$ in., $m = 5$ in.

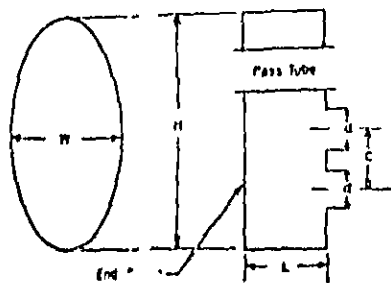

Figure 19. Flow-Reversing Chamber With Pass Tube and End Plate. C - Distance Between Centers of Inlet and Outlet Tubes; H - Height of Chamber; L - Length of Chamber; W - Width of Chamber; and d - pipe Diameter

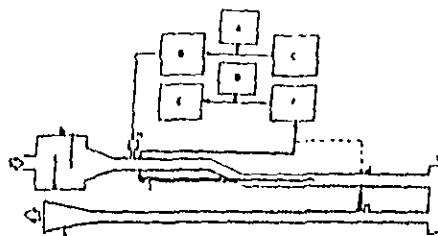

Figure 20. Experimental System for Measuring the Transmission Loss. A - Frequency Counter; B - Amplifier; C - Frequency Oscillator; D - Oscilloscope; E - Level Recorder; F - Spectrometer; G - Plenum Chamber; H - Acoustic Driver; I - Microphone Probe; J - Standing Wave Tube; K - Flow-Reversing Chamber; L - Anechoic Termination; and M - Microphone Port.



Figure 21. Transmission Loss for 51-CO Flow-Reversing Chamber (L = 2.0 in., H = 9.0 in., W = 4.75 in.). Open Square - Predicted by Theory for No Flow Condition. Open Triangle - Measured Without Flow. Circle - Measured With Flow at 110 ft/sec.

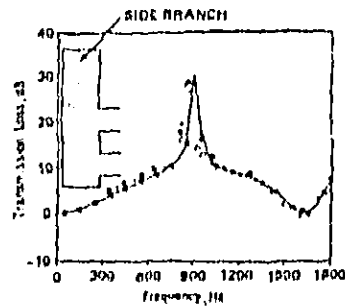

Figure 20. Transmission Loss for 51-5D Flow-Reversing Chamber (L = 2.0 in., H = 9.0 in., W = 4.75 in.). Open Square - Predicted by Theory. Plus - Measured Without Flow; Open Triangle - Measured Without Flow (End Plate Vibration Eliminated); Circle - Measured With Flow at 110 ft/sec.

Figure 22. Transmission loss characteristics for SI-50 muffler chambers: --- flow-reversing chamber only - predicted; — flow-reversing chamber and resonator - predicted; and + is the measured data for the flow-reversing chamber and resonator

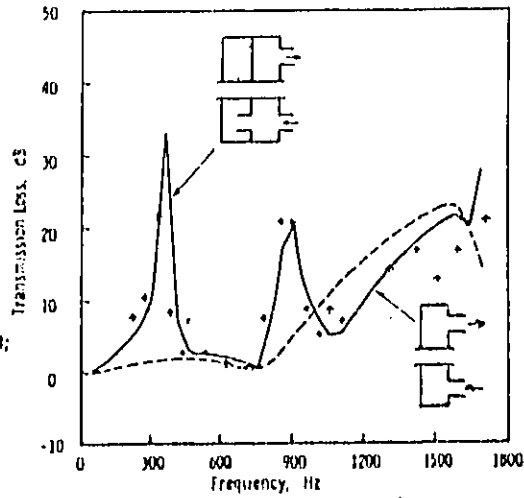
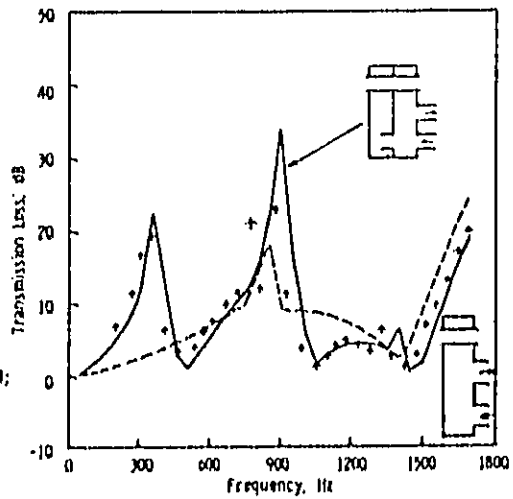

Figure 23. Transmission loss characteristics for SI-60 muffler chambers: --- flow-reversing chamber only - predicted; — flow-reversing chamber and resonator - predicted; and + is the measured data for the flow-reversing chamber and resonator



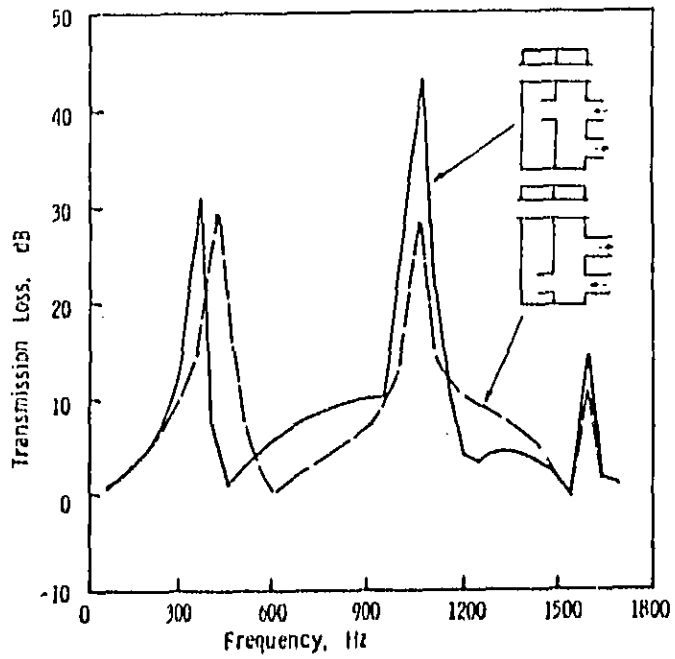

Figure 24. Predicted Transmission Losses for Combination of Si-CO Flow-Reversing Chamber and Helmholtz Resonator, With Different Throat Locations: ---- Side-Located Throat and — Centrally Located Throat

Figure 25. Transmission loss characteristics for combination of S1-CO and C1-SO flow reversing chambers; — is predicted; o is measured without flow and e is measured with a flow speed of 32 m/s

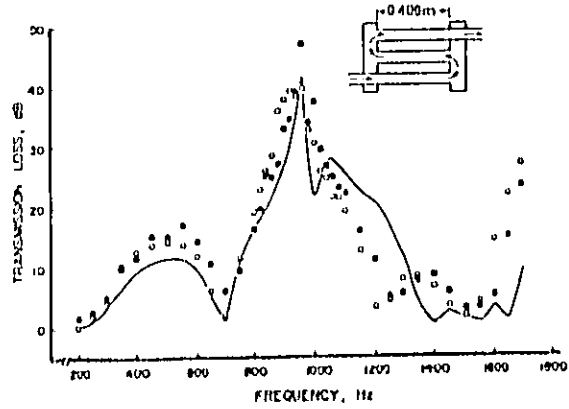

Figure 26. Transmission loss characteristics for combination of S1-CO and C1-SO flow reversing chambers; — is predicted; o is measured without flow and e is measured with a flow speed of 32 m/s

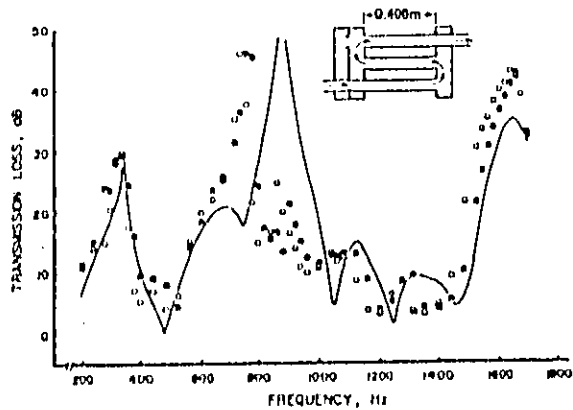
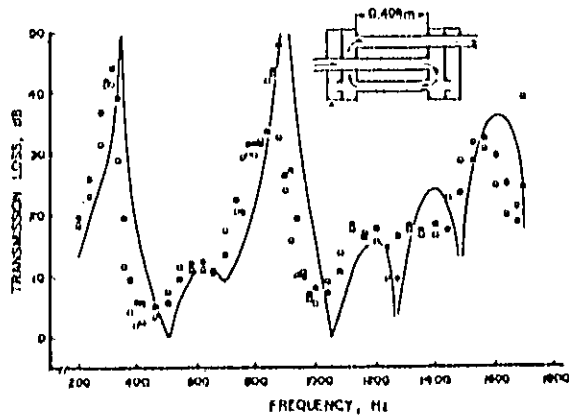

Figure 27. Transmission loss characteristics for combination of C1-SO and S1-SO flow reversing chambers with two resonators; — is predicted; o measured without flow; and e is measured with a flow speed of 32 m/s



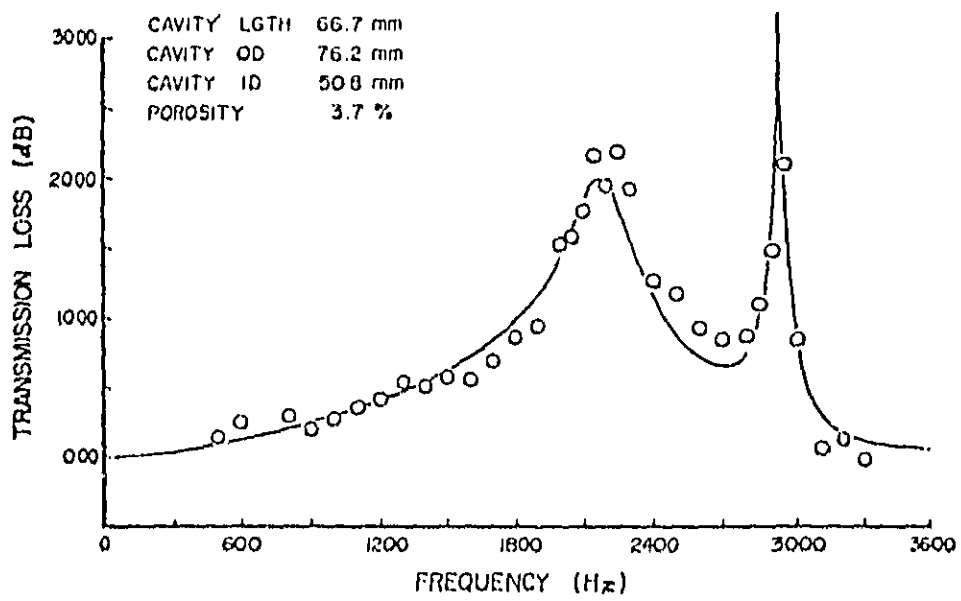

Figure 28. Transmission Loss for a Short Resonator, (Predicted —, Measured o)

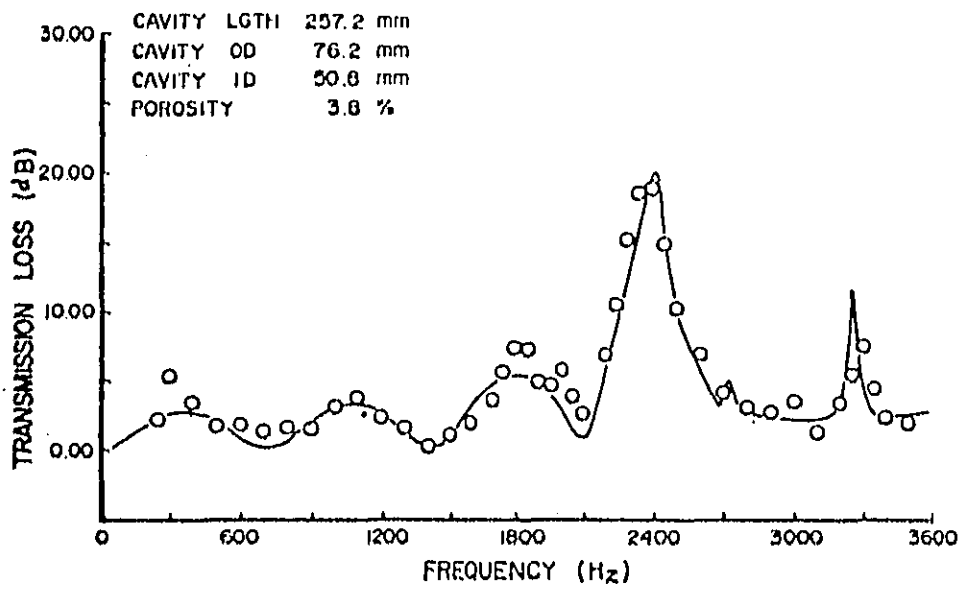

Figure 28. Transmission Loss for a Long Resonator, (Predicted —; Measured o)

CAVITY LGTH 66.7 mm
 CAVITY OD 76.2 mm
 CAVITY ID 50.8 mm

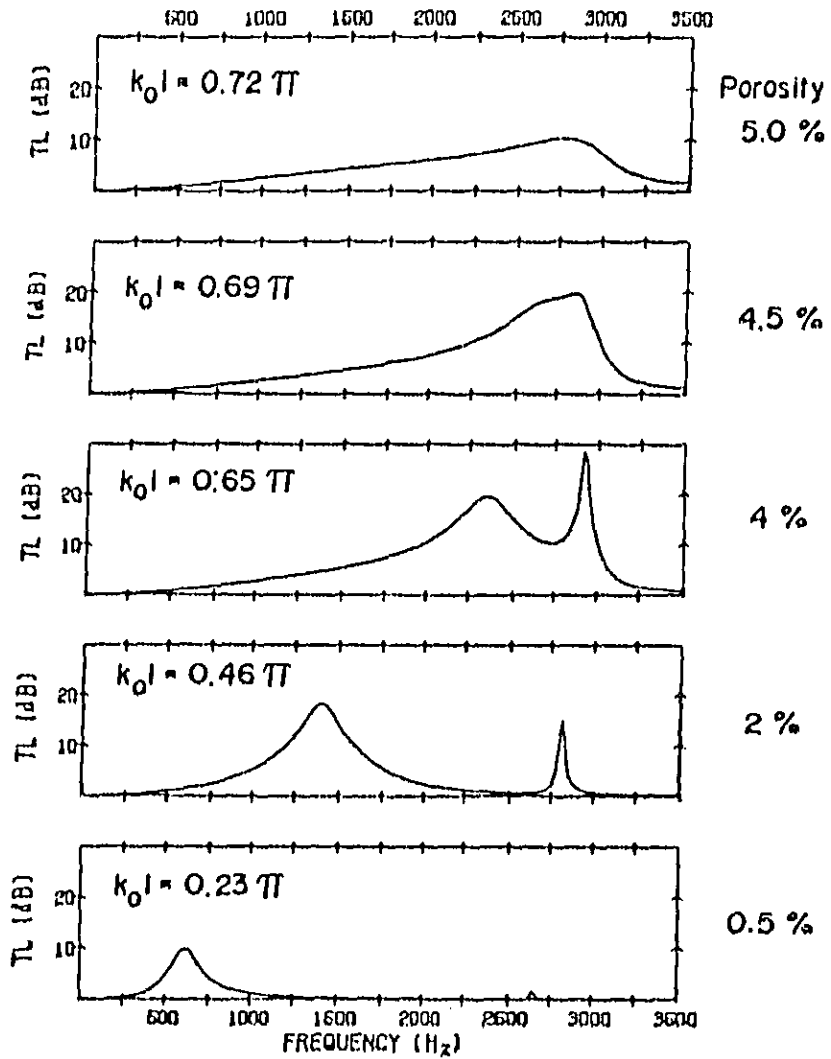

Figure 30. Effect of Porosity on Transmission Loss for a Short Resonator, Predicted From Mathematical Model

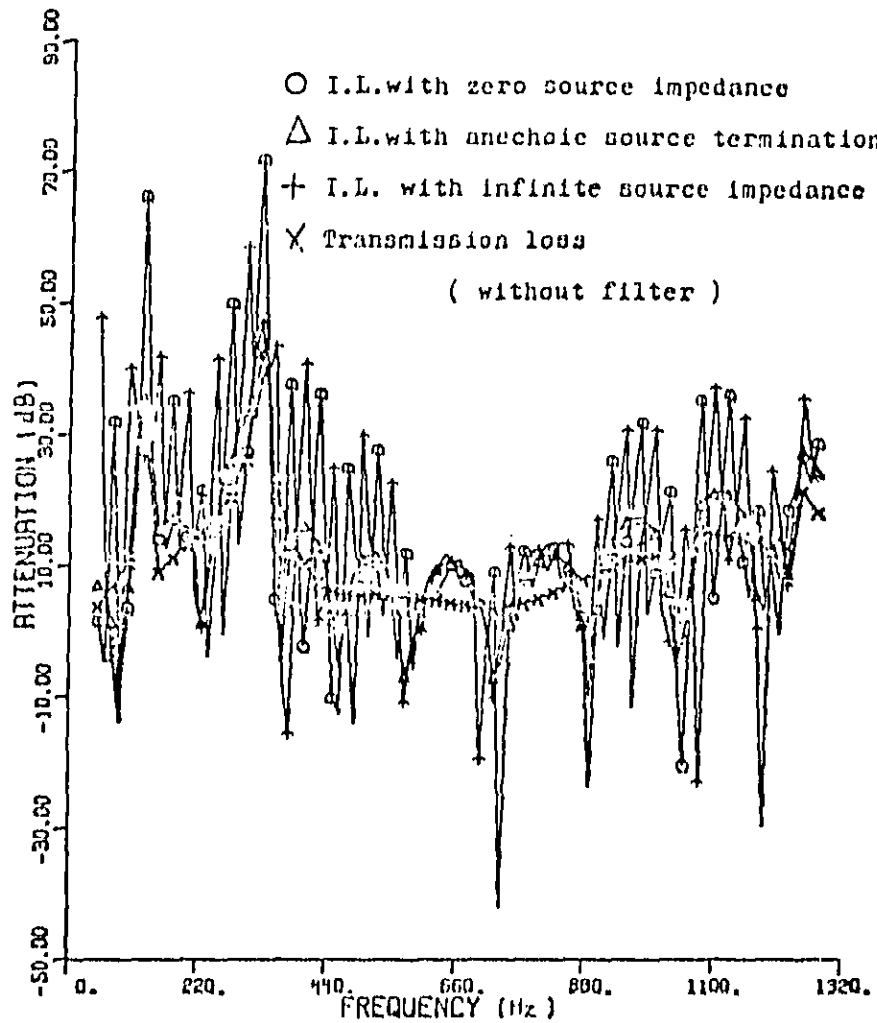

Figure 31. Theoretical Insertion Losses and Transmission Loss for Engine Exhaust Muffler System with Actual Exhaust Temperature Profile at Firing Frequency 100 Hz

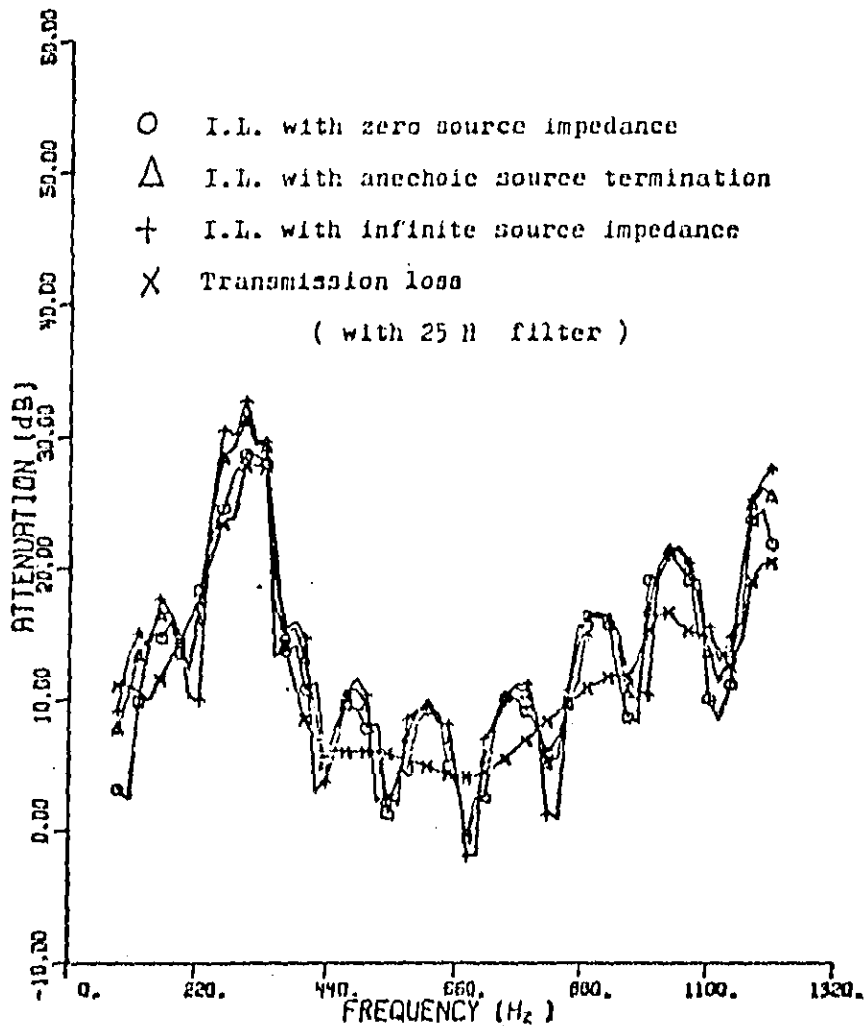

Figure 32. Theoretical Insertion Losses and Transmission Loss for Engine Exhaust Muffler System at Elevated Temperature at Firing Frequency 70 Hz

SHOCK-TUBE METHODS FOR SIMULATING EXHAUST PRESSURE
PULSES OF SMALL HIGH-PERFORMANCE ENGINES

B. Sturtevant and J. E. Craig

California Institute of Technology
Pasadena, California

ABSTRACT

The unique aspects of steep-fronted, large-amplitude pressure pulses that occur in the exhaust systems of small high-performance internal-combustion engines are reviewed. Some special analytical and experimental techniques that are useful for testing, simulating and analyzing such exhaust systems are described. Two examples are given of wave-diffraction effects which are particularly important when the incident waves are steep-fronted and which significantly affect the performance of simple muffler elements in these circumstances. The radiated noise due to these diffracted waves after their passage through the exhaust system can be strongly affected by gas dynamic nonlinearity. It is concluded that any procedure for qualifying mufflers of high-performance engines must accurately simulate the unique features of the exhaust dynamics of these systems.

1. Introduction

In this paper we review the unique aspects of the exhaust dynamics of small, high-performance internal-combustion engines and the special techniques that should be used in testing, simulating and analyzing their exhaust systems. In this regard, the most important feature of small engines operating at high rpm is the fact that the pulses generated by the opening of the exhaust valve or port tend to be steep-fronted and of large amplitude. Risetimes of pressures measured near the exhaust port of both 2- and 4-stroke engines commonly range from 0.1 to 1 msec (Refs. 1-4), so the thickness of the first pulse as it exits the exhaust port is in the range 2 - 20 cm. Furthermore, a large-amplitude pulse tends to get thinner as it propagates, by nonlinear steepening. A pulse with amplitude 0.5 bar will steepen to a discontinuity after propagating a distance only 3 times its initial thickness. Therefore, for example, a pulse with an initial risetime of 3/4 msec will steepen to a discontinuity after propagating 0.8 m.

When steep-fronted pulses occur in an acoustics problem it is more natural to treat the problem in the context of the theory of geometrical acoustics (Ref. 5), than by spectral decomposition and harmonic analysis. In geometrical acoustics the analysis is carried out in the time domain, so the physical processes are more transparent and the results more intuitively obvious. The theory of geometrical acoustics has been extensively developed, including the treatment of diffraction effects (Ref. 6). Application of nonlinear boundary conditions is straightforward. Furthermore, pulse theory can be directly extended to account for effects of gasdynamic nonlinearity (Ref. 7), while consideration of nonlinear effects in the frequency domain is cumbersome and unproductive.

Therefore, when the thickness of the compressive portions of the pressure pulses in the exhaust systems of small high-performance engines is of the order of or smaller than typical transverse dimensions (i. e., the largest diameter), it is useful for determining acoustic performance to trace the propagation of the pulses through the system and to study their interactions. This is especially true if one is interested in the emitted noise because noise in the far field is generated by the

rate of change of volume flux at the source. Therefore, most of the noise originates at the steep fronts of the waves. At Caltech we have conducted some experiments in shock-tube facilities¹, in which the pulses incident on exhaust systems are discontinuous fronts (weak shock waves). This simplification has permitted the observation of two previously unexpected diffraction effects which may be important sources of noise (self noise) in applications with steep-fronted pulses. The spiked waveforms typical of diffracted waves are sensitive to the effects of gasdynamic nonlinearity, so propagation in straight sections of pipe (e. g., the tailpipe) can have important effects on the emitted noise.

It is concluded that any procedure for testing mufflers for small high-performance engines must include provision for measuring the effects of fast pulse risetimes and finite amplitudes. Though the apparatus used at Caltech has not been developed for use in a standardized procedure, it is possible that shock-tube facilities can be used to simulate these features of exhaust pulses of high-performance engines. Of course, shock tubes do not duplicate all the characteristics of engine noise sources, so they should be used only to supplement the information obtained in other, perhaps more conventional, tests.

In this paper we first describe the test apparatus and then cite, as proof that finite-amplitude effects must be accounted for, two examples of two-dimensional diffraction effects which are influenced by gasdynamic nonlinearity.

2. Experimental Apparatus

In systems with large - amplitude unsteady motion, the maximum instantaneous flow velocity may be substantially larger than the mean velocity. Therefore, there may be substantial inflow from the atmosphere into the exhaust system during certain portions of the cycle. Because of viscous effects and separation, flow out of an area expansion (jet flow), is fundamentally different from flow into a converging section of tube (sink flow), so the occurrence of flow reversal

¹ Complete details of the experimental apparatus, the research program and some findings of the fundamental behavior of finite-amplitude waves in exhaust systems may be found in Ref. 1.

during a portion of the cycle can be an important source of departure from ideal acoustic behavior. For example, our work has shown that the performance of perforated tubes in mufflers can be greatly affected by the existence of inflow into the muffler from the atmosphere before arrival of the main pulse. In the present experiments we use two different facilities, a periodic source and a single-shot source, to bracket the effects of inflow. The two devices are represented schematically in Figure 1.

Resonance Tube The resonance tube (Figure 2) is a long gas-filled tube which is excited at one end by a reciprocating piston and terminated at the other end with the exhaust system to be studied. The piston is driven at the fundamental acoustic resonance frequency of the tube, and its amplitude is large enough that at resonance the compressive portions of the waveform steepen to form a shock wave travelling back and forth in the tube. Thus, the resonance tube is used as a wave generator to supply large-amplitude steep-fronted periodic waves for exciting the exhaust system. A comparison between the resonance-tube waveform and a typical pressure history measured at the exhaust port of a 250 cc single-cylinder two-stroke engine, when both sources are connected to a high-performance expansion chamber exhaust system, is given in Figure 3.

Provision is made for measuring internal pressures at several locations in the exhaust system and for measuring free-field radiated noise. Data are acquired by a computer-controlled data acquisition system, and all data are processed in real time and the results are output in plotted format shortly after completion of a run. The data acquisition is synchronized with the piston crank mechanism through a 256-tooth gear mounted on the crank shaft and a magnetic pickup. This has the important consequence that spectra calculated by a Fast Fourier Transform (FFT) algorithm are actually exact Fourier analyses of the periodic signal, and it is not necessary to apply window functions, etc., to the sampled data to insure adequate accuracy of the results.

Shock Tube. The shock tube (Figure 4) is a conventional pressure-driven shock tube to which is attached the exhaust system to be studied. In order to maximize the uniformity of the input shock wave a "cookie-cutter" configuration, in which the exhaust pipe is extended inside the shock tube, is used. Provision is made for measuring internal pressures and free-field radiated noise. The same data-acquisition system as was used with the periodic system described above is also used with the single-shot shock tube. Further details of the experimental technique are given in Ref. 1.

Only very simple muffler configurations have been studied in this work, for the purpose of examining the fundamentals of wave-propagation in exhaust systems. However, the results are sufficient to demonstrate the utility of the experimental method. The repeatability of the results and the accuracy of the measurements are such that many effects related to noise suppression are easily visible on the pressure traces. Therefore, the method is also useful for diagnostic analysis and for muffler-design optimization.

3. Perforated Tubes in High-Performance Mufflers

Experiments have been carried out to determine the mechanism by which perforated tubes in mufflers attenuate acoustic pulses. Figure 5 shows the simple straight-through configurations tested (enclosures A, B and C are defined in Figure 9) and identifies the notation for the transducer locations U, D1 and D2 used in subsequent figures. The perforations are 6.35 mm dia drilled holes and are arranged so that the open area per unit wall area is approximately 1/6. The total area A_E of the perforations in a given test is set by the number of holes in the tube and is characterized by the ratio A_E/A , where A is the tube cross-sectional area.

Oscilloscope traces of internal pressures measured at three different locations in a single-pulse excited system, with three different values of A_E for an "infinite" enclosure (perforations open to the room) are shown in Figure 6. They generally confirm results obtained in previous studies of perforated tubes (Refs. 8 and 9). The upstream traces show the incident shock followed by an expansion wave reflected

from the perforations. The downstream traces show the detailed structure of the transmitted wave. The final steady-state pressure behind the transmitted wave is well accounted for by a simple analytical model of the sink effect of the flow through the perturbations (with a reduced orifice discharge coefficient due to axial momentum in the jets), but the spike and pressure minimum observed especially for large Λ_E/Λ are unpredicted 2 - dimensional effects and are obviously important with regard to noise emission. When the perforation area is large, evidently the shock is not immediately attenuated to its theoretical value. Particularly in the case $\Lambda_E/\Lambda = 0.89$ in the figure, the effect of propagating between D1 and D2 in the tailpipe is evident; the shock discontinuity and the very rapid expansion wave, which is probably made up of (2 - dimensional) diffracted waves from the numerous orifices, interact, resulting in an attenuation (and slow disappearance) of the pressure spike. This attenuation is due entirely to gasdynamic nonlinearity; if there were no nonlinear effects the spike would be much larger, a fact which is born out by the fact that it shows up much more strongly for the weaker waves in our experiments (Figure 6) than for stronger waves, where nonlinear effects are larger. The fact that important attenuation can occur during propagation down the straight tailpipe emphasizes the importance of testing complete muffler systems in obtaining noise suppression data for high-performance engines.

Figure 7 summarizes the overall effect of perforations on radiated noise. Though a small spike persists at D2, the main effect has been to slow the rise of the compression in the pipe to a very much larger value than that of the input discontinuity, vastly reducing the far-field (location F) noise level (a shock of the same amplitude would yield about 1 mBar amplitude, vs. the 0.12 observed). However, the small surviving pressure spike remains the major noise source!

Figure 8 shows the effect of finite enclosures surrounding the perforations. The effects of waves excited by the passage of the incident shock reflecting back and forth in the enclosures are evident, particularly in the radiated noise, where secondary spikes now occur. With the experimental technique used in this work it is even possible to see that the odd-numbered secondary peaks at D1 are

smoother than the even-numbered, due to the nature of wave propagation in the muffler, with the consequence that the corresponding spikes in the far field are much weaker!

4. Expansion Chambers

Figure 9 shows the simple expansion chamber configurations tested in the present work. It is well known that when the acoustics of expansion chambers is considered from the pulse point of view one can trace the waves as they reflect back and forth in the expansion chamber interacting with the discontinuous area changes, as shown schematically in Figure 10. Indeed, each and all of the infinite number of infinite series of waves can be summed in closed form to give the overall transmitted wave field, but this always gives too large a value for the radiated noise because viscous dissipation during the wave interactions has been neglected. However, within the pulse point of view it is a very direct and effective artifice to simply truncate the series at some finite number of terms to provide a first-order correction for the effects of dissipation. In any case, if the spectrum of the transmitted waveform is calculated it is seen that the multiple reflections of the discrete fronts have the same effect as the familiar superposition of incident and reflected waves in a spectrum of harmonic excitations, both points of view showing the effects of destructive interference.

The geometrical point of view shows immediately that the manner in which an expansion chamber serves to attenuate an acoustic pulse is to break up the single incident pulse into a series of weaker waves. In a sense, the transmitted wave is stretched out into a more gradual compression, so the net effect is the same as with the perforated tube discussed above. Indeed, after a comparative study of both devices, one would conclude that the optimum combination of elements in systems where wave amplitudes are large would be a series arrangement with the expansion chamber first, followed by the perforated tube (cf. Ref. 1).

However, one phenomenon that one-dimensional theory can not predict is the diffraction of wave fronts at discontinuous area changes. Figure 11 depicts schematically the geometry of the actual wave fronts

generated when a wave diffracts from the end of an extended inlet and, in the bottom sketch, the representation of the process by one-dimensional theory. To the extent that the multitude of diffracted fronts persist as they propagate in straight sections of tube, the noise emitted by the system may be seriously underestimated by one-dimensional considerations.

Figures 12 and 13 show two examples of interior and free-field wave forms observed in experiments with two different expansion chambers. The multiple reflections of the incident front in the expansion chamber are evident in the reflected and transmitted waves, but superimposed on these waves are very high frequency fluctuations due to diffracted waves. In this case, contrary to the behavior in perforated tubes, gasdynamic nonlinearity aggravates the situation, because, as is well known, the wavelength of a nonlinear sawtooth wavetrain tends to saturate at a constant value, while linear diffracted waves tend to "merge" simply by geometrical spreading from their point of origin. In Figure 13 the diffracted waves at location D3 have formed a sawtooth waveform containing shocks and have the same spacing as at D1, indicating nonlinear saturation. Their large contribution to the radiated noise at location F is obvious. At D3 the amplitude of several of the diffracted waves is more than 10% of the amplitude of the single incident shock. The relative strength of the diffracted waves increases as the expansion chamber diameter increases, so in fact the noise attenuation of an expansion chamber peaks out at a particular area ratio and fails to increase beyond that value.

5. Conclusions

It has been shown that some unique features of the steep-fronted large-amplitude pressure pulses in the exhaust systems of high-performance internal-combustion engines require accurate simulation in procedures for testing and qualifying mufflers. An experimental technique which simulates the actual pulses with discontinuous pressure rises (weak shocks) is described. The technique has the advantage that is also useful to the designer for diagnostics and design modification. Two examples have been given of two-dimensional phenomena that are not accounted for in one-dimensional analyses but which are particularly important when the pulses are steep-fronted.

References

1. J. E. Craig, "Weak Shocks in Open-Ended Ducts with Complex Geometry", Ph. D. Thesis, California Institute of Technology, Pasadena, CA. (1977), Figure 7.
2. G. P. Blair and J. A. Spechko, "Sound Pressure Levels Generated by Internal Combustion Engine Exhaust Systems", SAE Trans. 81, 563 (1972), Figure 4.
3. W. A. Huelsse, "Investigation and Tuning of the Exhaust System of Small Two-Stroke Cycle Engines", SAE Trans. 77, 563 (1968), Figure 17.
4. M. Leibor, "The Exhaust System of the Two-Stroke Cycle Engine", SAE Trans. 77, 1846 (1968), Figures 22, 24.
5. J. B. Keller, "Geometrical Acoustics, I. The Theory of Weak Shock Waves", Jour. App. Phys. 25, 938 (1954).
6. F. G. Friedlander, Sound Pulses, Cambridge University Press (1958).
7. G. B. Whitham, Linear and Nonlinear Waves, John Wiley and Sons (1974), Ch. 8.
8. J. H. T. Wu and P. P. Ostrowski, "Shock Attenuation in a Perforated Duct", in Shock Tube Research (ed. J. L. Stollery, A. G. Gaydon and P. R. Owen), Chapman and Hall, London (1971).
9. A. P. Szumowski, "Motion of a Shock Wave Along a Perforated Duct", Prace Nauk. Mech., Politech. Warszawska, Nr. 18 (1972).

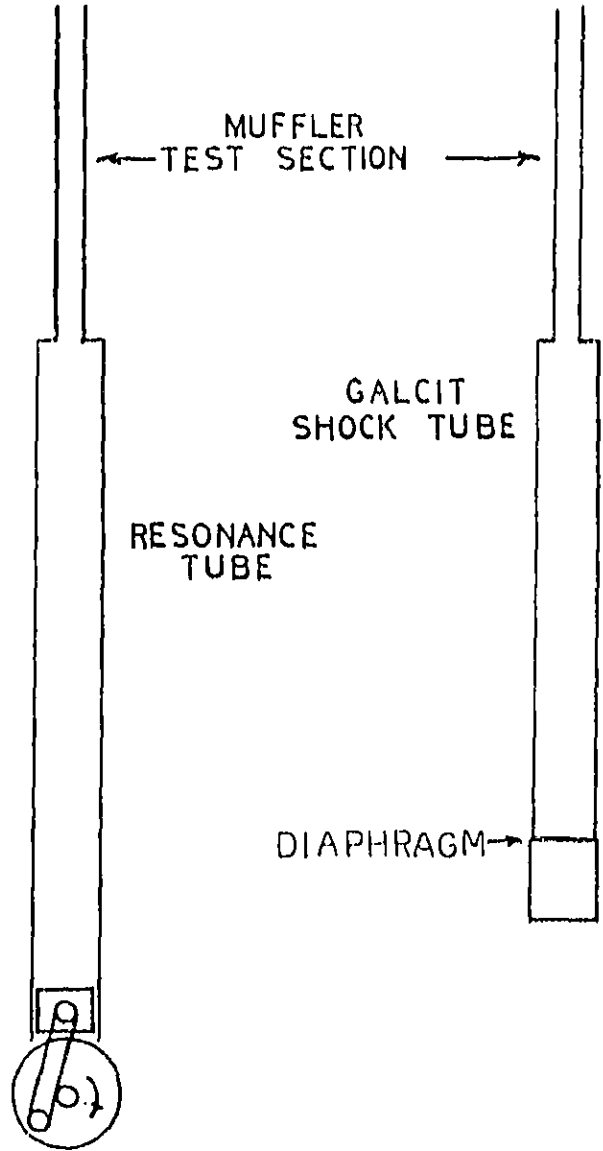

FIGURE 1 THE GEOMETRY OF EXPERIMENTAL FACILITIES

REST AVIATION

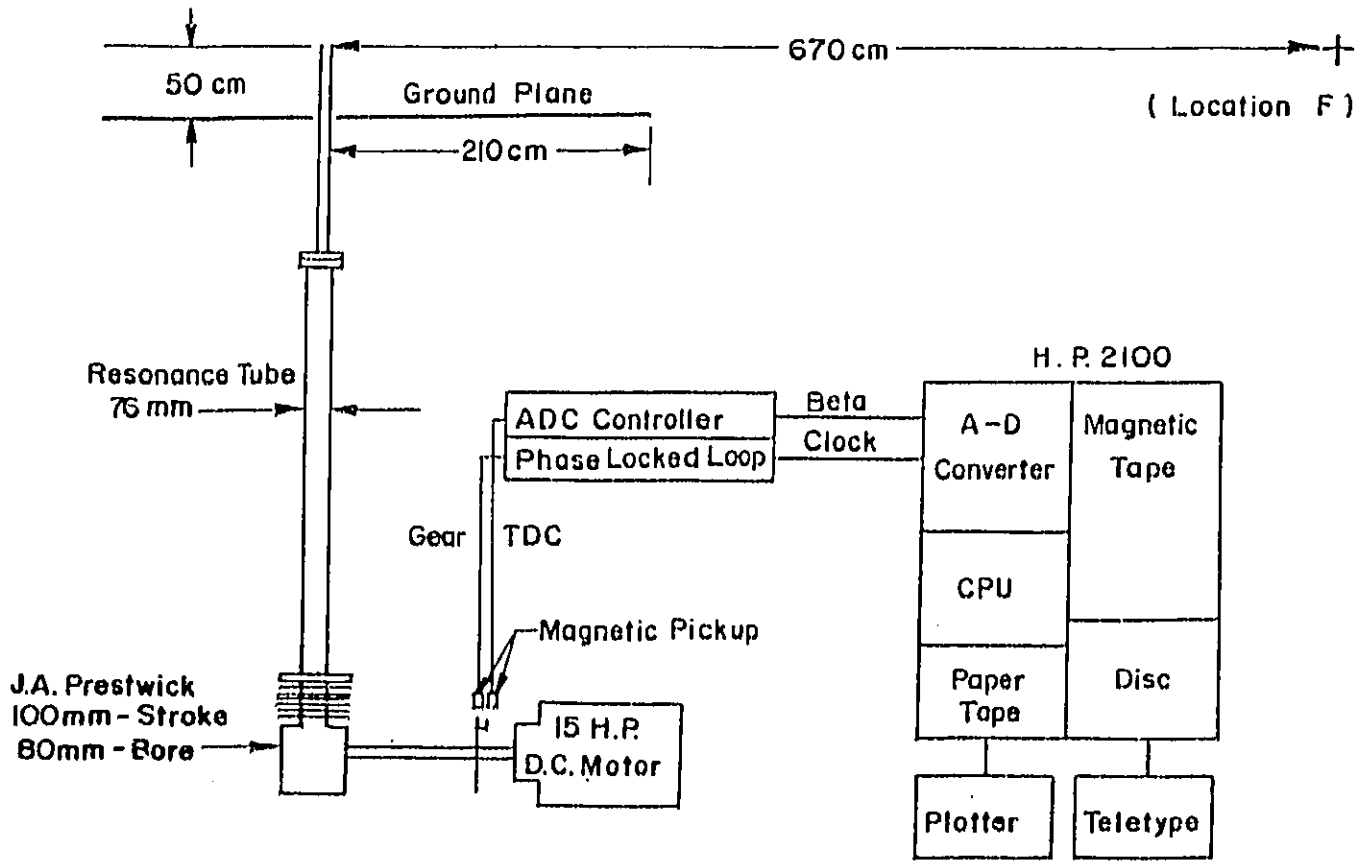
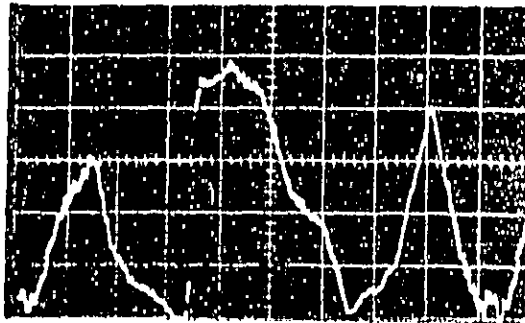
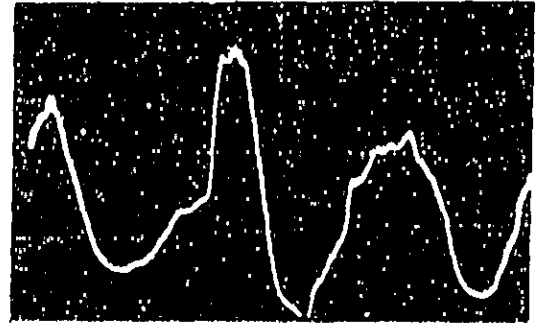

FIGURE 2



(a)
front
(arbitrary scale)



(b)
front
Vertical scale $138 \frac{mB}{cm}$
Horizontal scale $1 \frac{mS}{cm}$

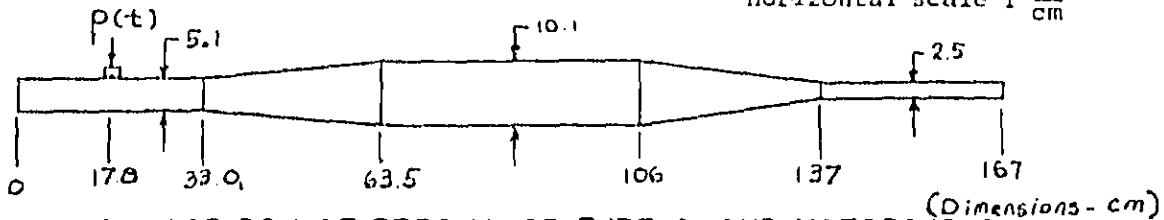

FIGURE 3 COMPARISON OF RESONANCE TUBE, A, AND MOTORCYCLE ENGINE, B, PRESSURE WAVE FORMS

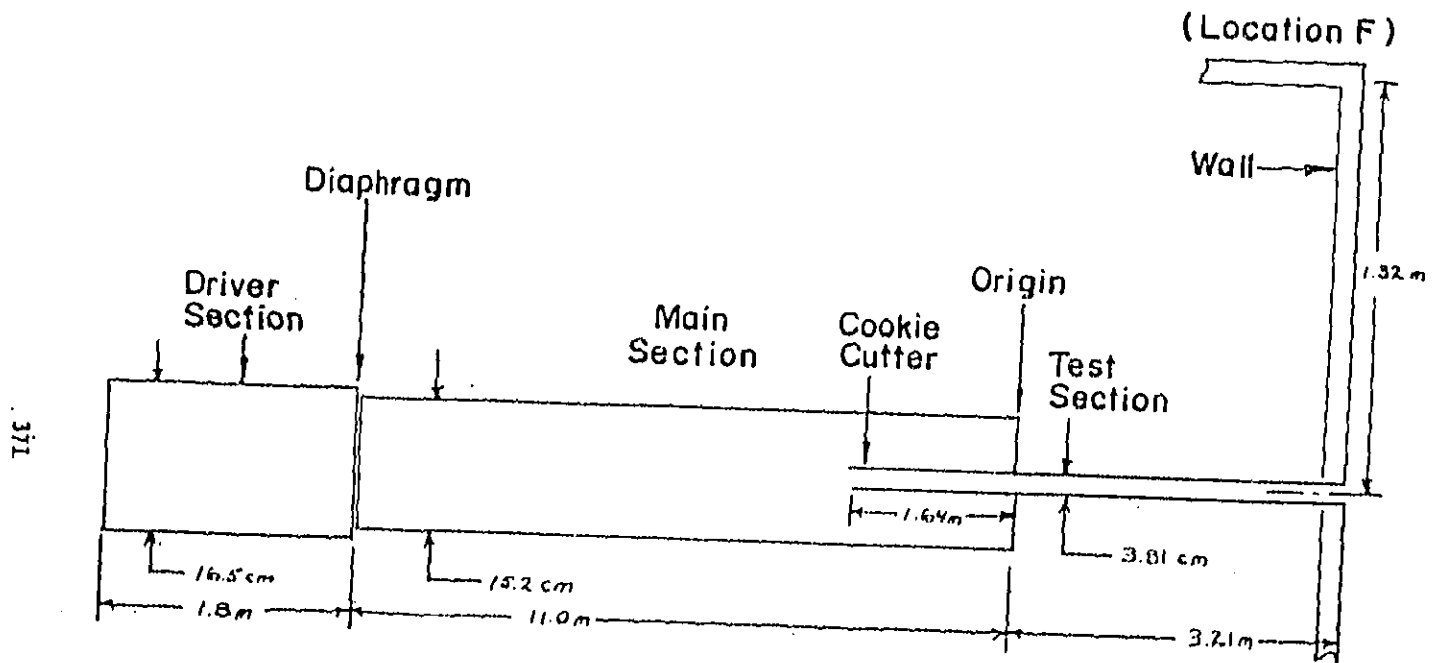

FIGURE 4 GALCIT SIX INCH SHOCK TUBE

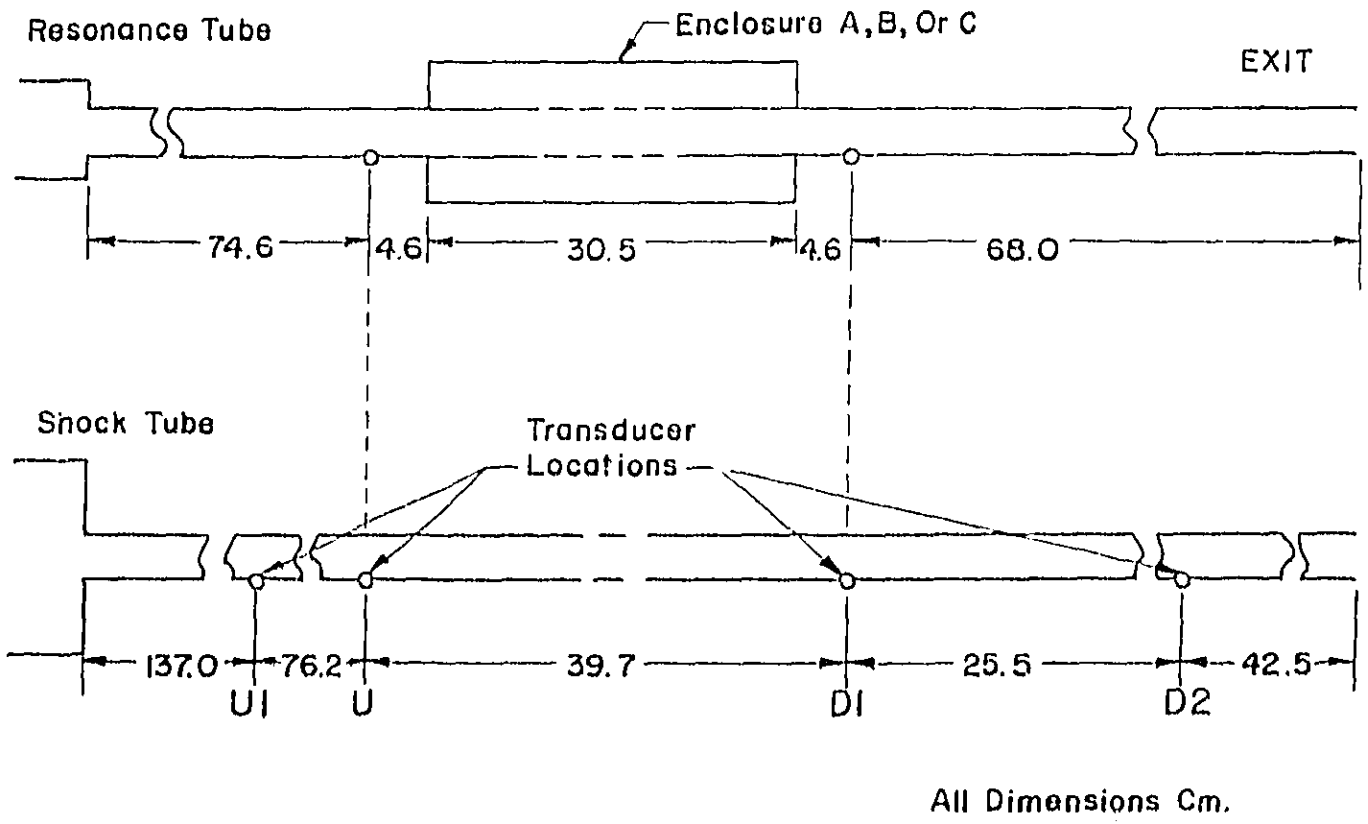
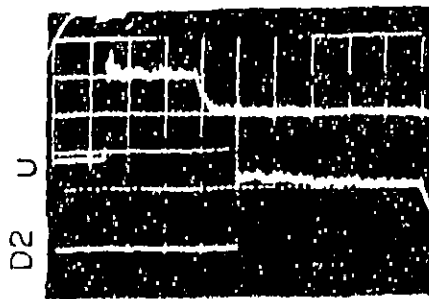
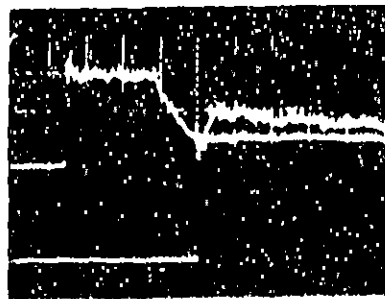

FIGURE 5 PERFORATION SYSTEMS



A_c/A 0.44



0.89

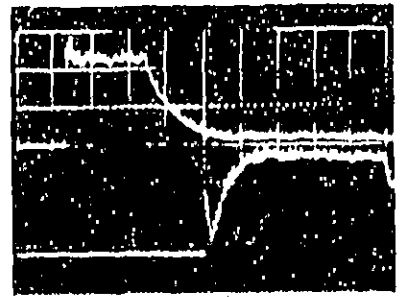

1.78

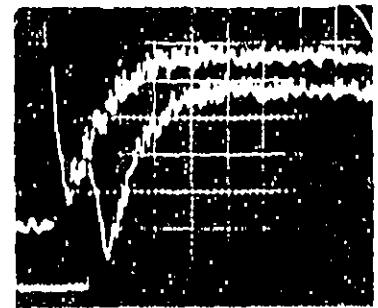
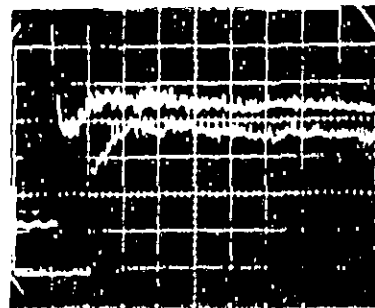
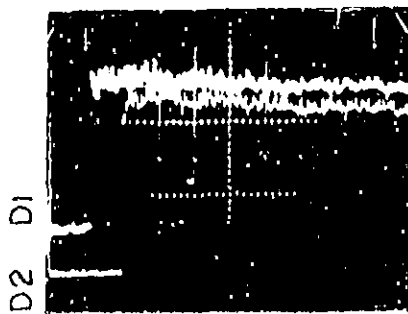

THE EFFECT OF PERFORATED AREA RATIO
ON REFLECTED AND TRANSMITTED WAVES.
(MACH NO. = 1.13)

FIGURE 6

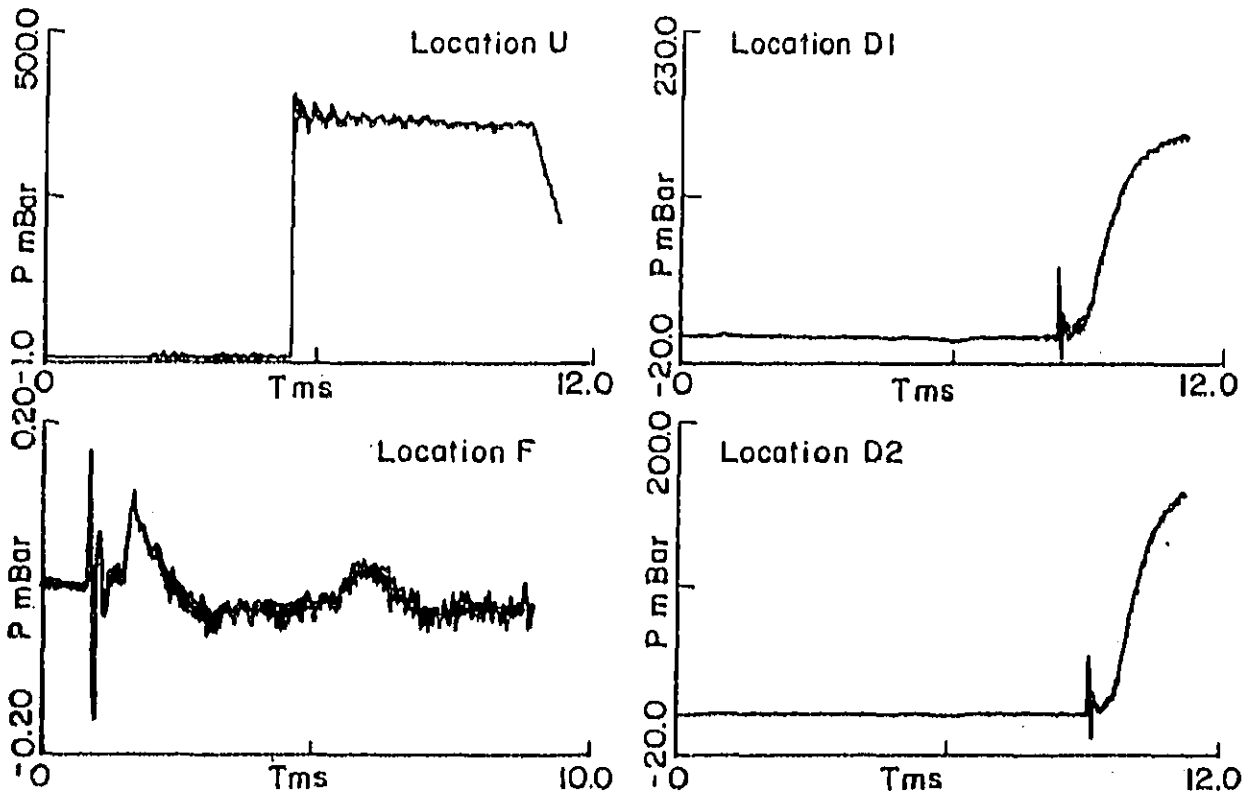

FIGURE 7 PRESSURE HISTORIES OF SHOCK PROPAGATION PAST A PERFORATED TUBE $A_E/A = 4.00$, SHOCK TUBE

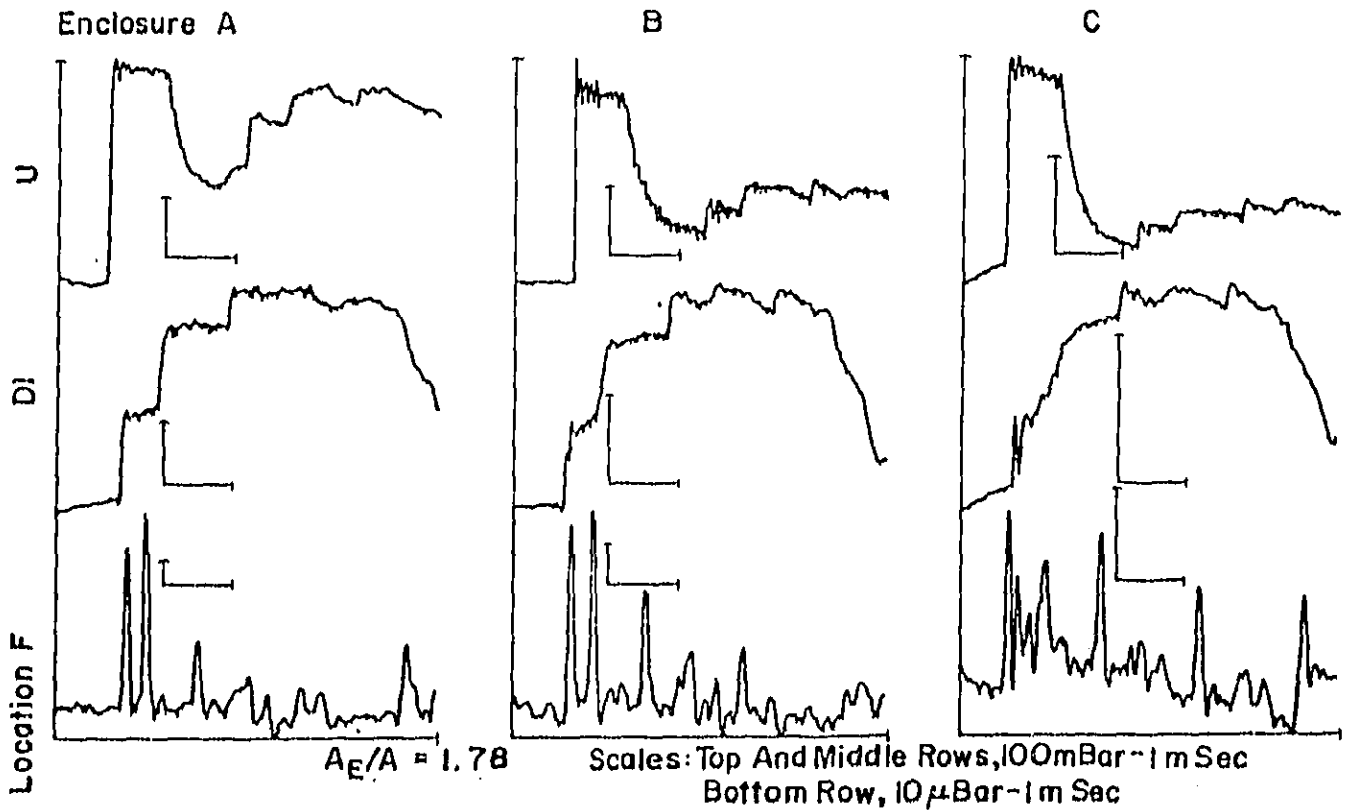
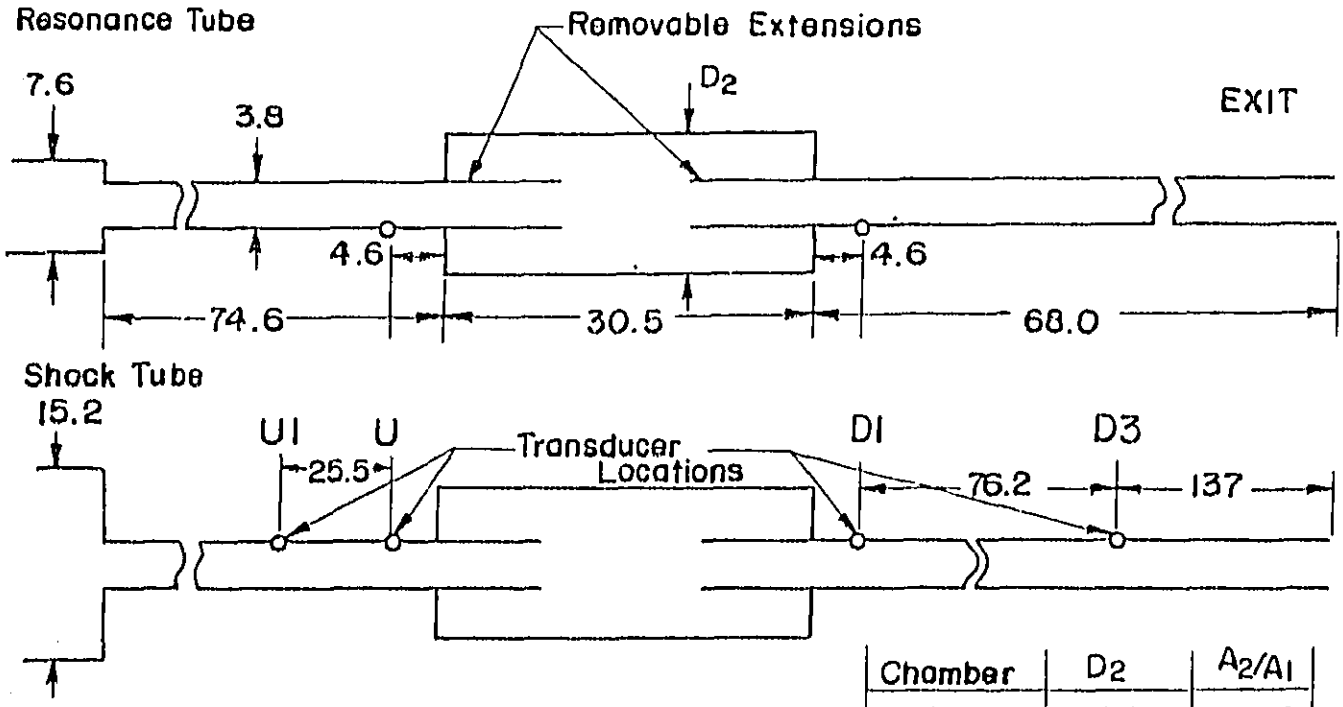

FIGURE 8 PRESSURE HISTORIES OF SHOCK PROPAGATION PAST PERFORATED TUBES, RESONANCE TUBE



Dimensions In Cm.

Chamber	D_2	A_2/A_1
A	6.35	2.77
B	8.25	4.69
C	11.4	9.00

FIGURE 9 EXPANSION CHAMBER SYSTEMS

376

BEST AVAILABLE COPY

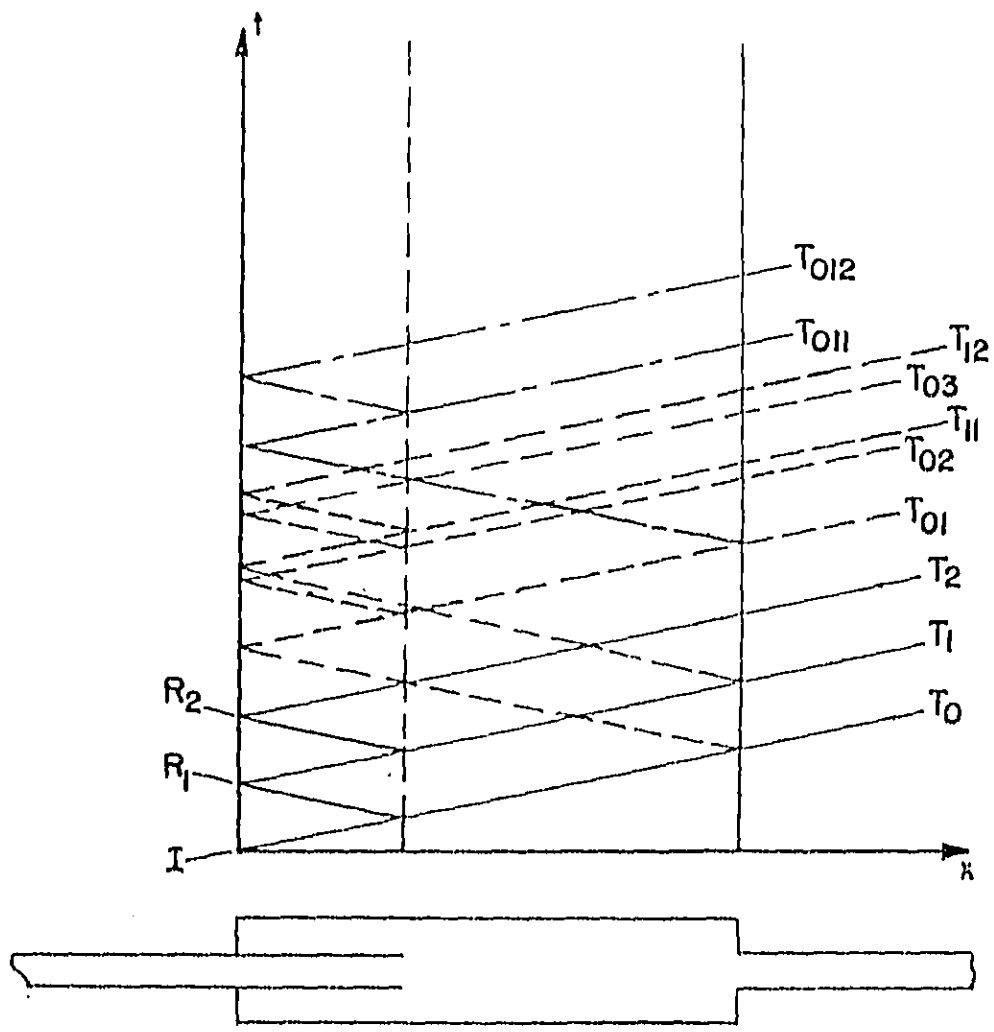

FIGURE 10 EXTENDED INLET SYSTEM

RECT-A-100-101-C-1000

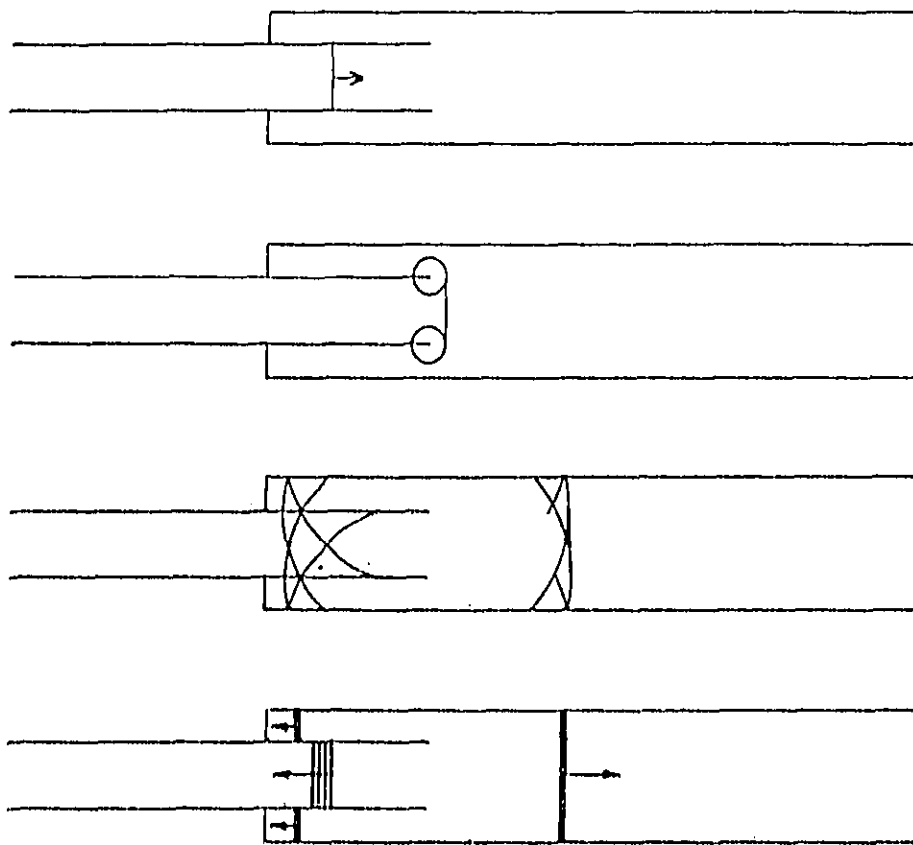

FIG. II. SHOCK INTERACTION WITH AN EXTENDED INLET

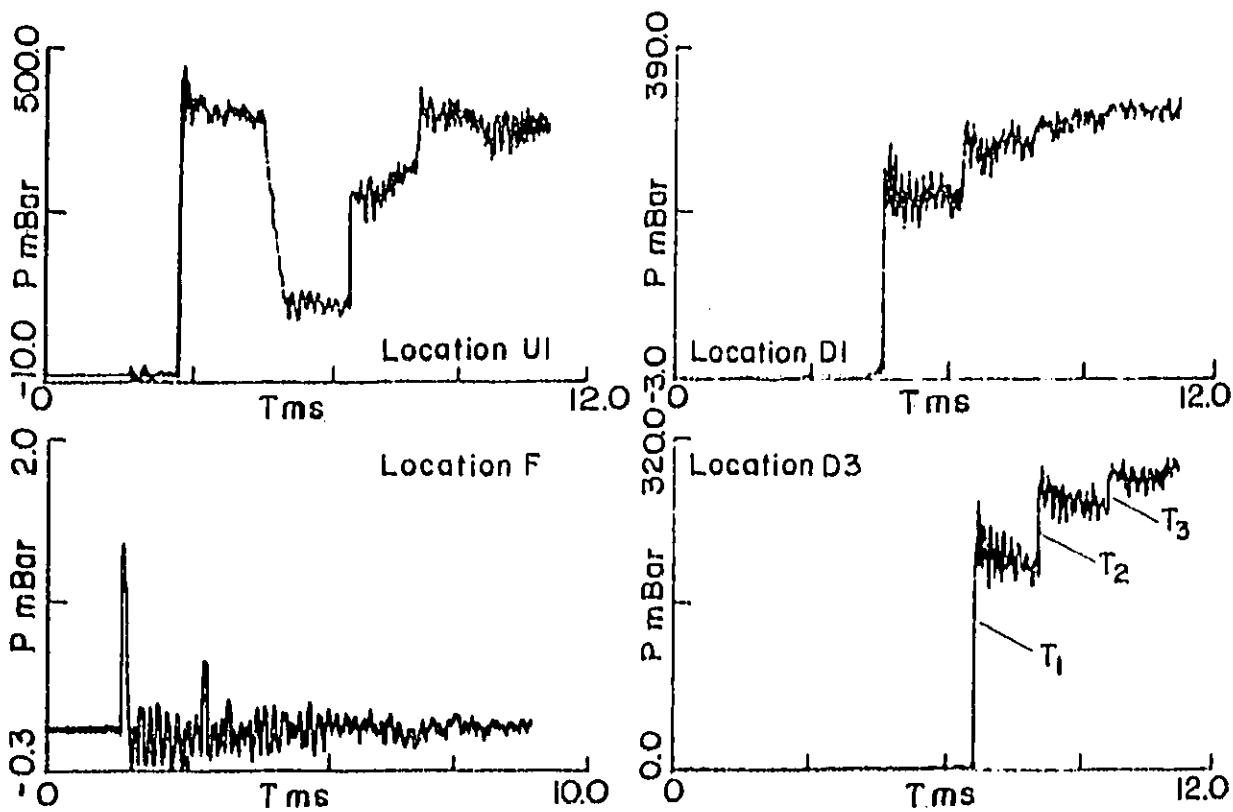

FIGURE 12 PRESSURE HISTORIES OF SHOCK PROPAGATION THROUGH EXPANSION CHAMBER, B. $M_s = 1.17$, SHOCK TUBE

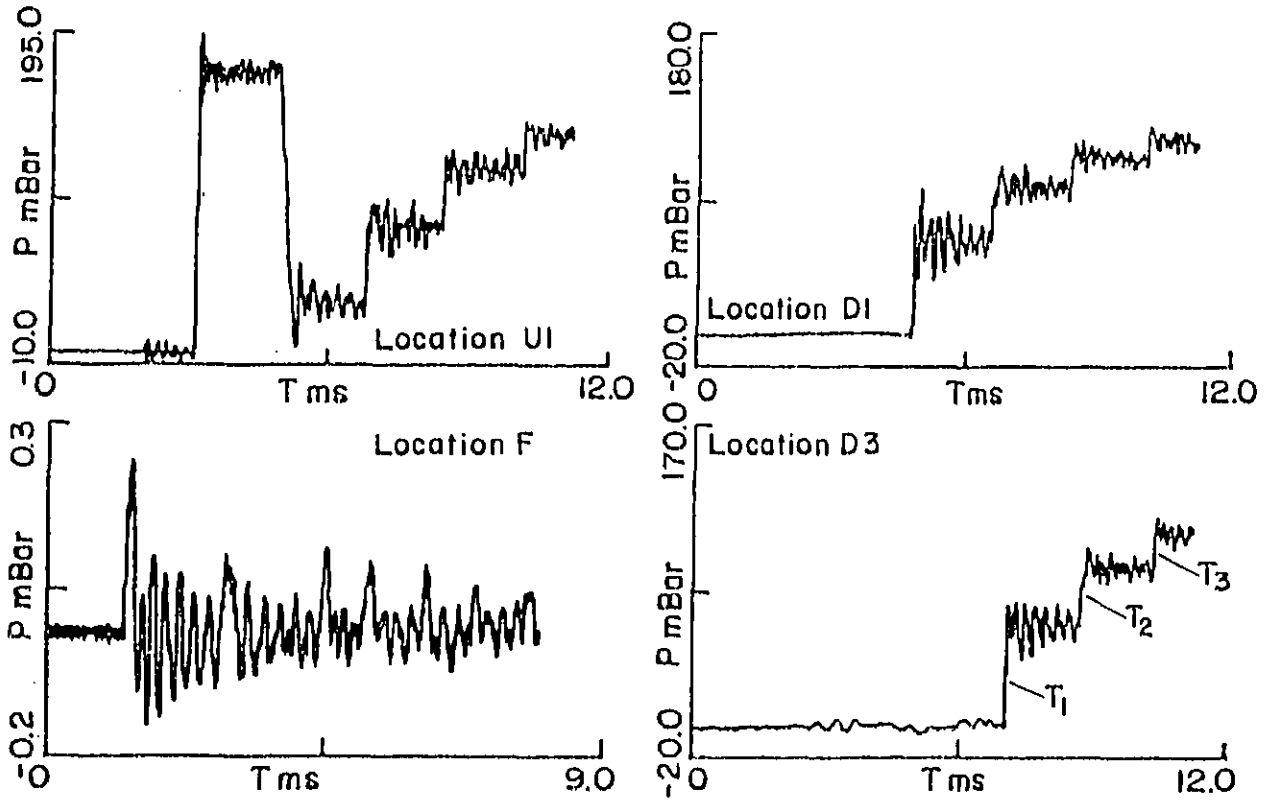

FIGURE 13 PRESSURE HISTORIES OF SHOCK PROPAGATION THROUGH EXPANSION CHAMBER, C. $M_s = 1.07$, SHOCK TUBE



NOISE SYMPOSIUM IN CHICAGO - OCTOBER 11-13, 1977

CORRELATION OR NOT BETWEEN BENCH TESTS AND OUTSIDE MEASUREMENTS
FOR SNOWMOBILES.

As you probably know, our company, BOMBARDIER LIMITED, is
involved in recreational vehicles and more particularly
in SKI-DOO snowmobiles.

With snowmobiles we are faced to three certification standards:

See slide no. 1

SSCC-55 which is a 15 MPH pass-by test;

SAE J-192a which is a full acceleration test;

ISO R-362 which is the European procedure.

During this symposium, up long, we have heard a lot in
theoretical predictions versus practical measurements on
bench tests. In this presentation I do want to go away from
this interesting aspect for having a good exhaust labelling.
I will try to compare practical bench test measurements to
actual measurements on the snowmobile itself.

WHY?

Because I am interested in the consumer point of view.
For a future buyer of any transportation vehicle, it is
important to give him the truth.



2/...

So we try to take the problem by the end. Let us suppose we have the right method to obtain practical measurements on bench test and let us try to see what is going to happen on the actual field test.

And, from now we are going to notice all the parameters which are involved in the sound of the exhaust. And, I am sure, that any of you can find even more than what we are going to speak of.

In order to eliminate partially the discussion of the influence of the other sources (air intake, track etc...) we use a vehicle in which muffler noise was supposed to be the greater source at least by 3 dB at fifty feet. You will ask why not more than 10 dB? Because this is never an actual situation and we were interested in seeing how changing muffler is combining in the spectrum with the other components.

At this point, concerning a possible method to measure exhaust noise at bench, please refer to next speaker, Jim Moore who is going to show you how bench test and outside measurement correlate in some particular conditions.

DEPT AVIATION AND SPACE



3/...

I OUTSIDE EFFECTS

First of all we have physical parameters which are generally:

i) WIND, which should not be more than 12 MPH.

But from "0" to 12 MPH you can easily imagine the consequences on performance (with free air engine), temperature of exhaust and angle of incidence which can help you a lot or not. Differences: up to 1.8 dB(A)

ii) AIR PRESSURE, we know that it affects sound transmissibility and performance. Not a lot for sure but enough to be considered. Differences: up to .8 dB(A)

iii) AIR TEMPERATURE, this of course is quite an important factor especially on snowmobiles which will run in a -40°C to 0°C range, and it is not easy to mix cold chamber and a semi-anechoic chamber:

And of course, temperature will affect the muffler itself but also the spectrum and the total value of each other sources. So it is quite a job to separate those effects and to obtain a significant comparison of typical values between different mufflers.



4/...

I OUTSIDE EFFECTS

iii) cont'd

Remember that a two-stroke engine with free air or fan cooled version, it is much more affected by the exhaust temperature than any liquid cooled engine.

Differences: up to 2.0 dB(A).

iv) RELATIVE HUMIDITY, every one of us know that it could affect performance quite a lot. It affects also sound reflexion and transmissibility. So are we going to take care of the humidity? You can control it on bench test. Yes, but for certifying a muffler, are you going to make this humidity vary from step to step to see where is the maximum? Certainly not. For development purposes, yes, but not for obtaining a rating level of the exhaust noise.

Differences: up to .8 dB(A).



5/...

II GROUND EFFECTS

Now speak of the most important point: ground effects.

This is quite particular to snowmobiles.

See slide no. 2.

In the procedure they tell us that you can use:

firstly: packed snow with not more than 3 inches of ordinary snow.

secondly: dry grass, 3 inches.

The problems are:

What is exactly packed snow? It could be ice, it could be just packed by passing on with a snowmobile.

What sort of grass and underground? We could get more than 1.5 dB(A) difference with the same grass type but with soft or hard ground underneath.

And also we have to speak of the fact that some models are unaffected when compared between grass and snow. Others could get differences up to 2.5, even 3 dB(A).

We know that snow is much better than grass and of course asphalt, to absorb low frequencies.

See spectrum no. 1.

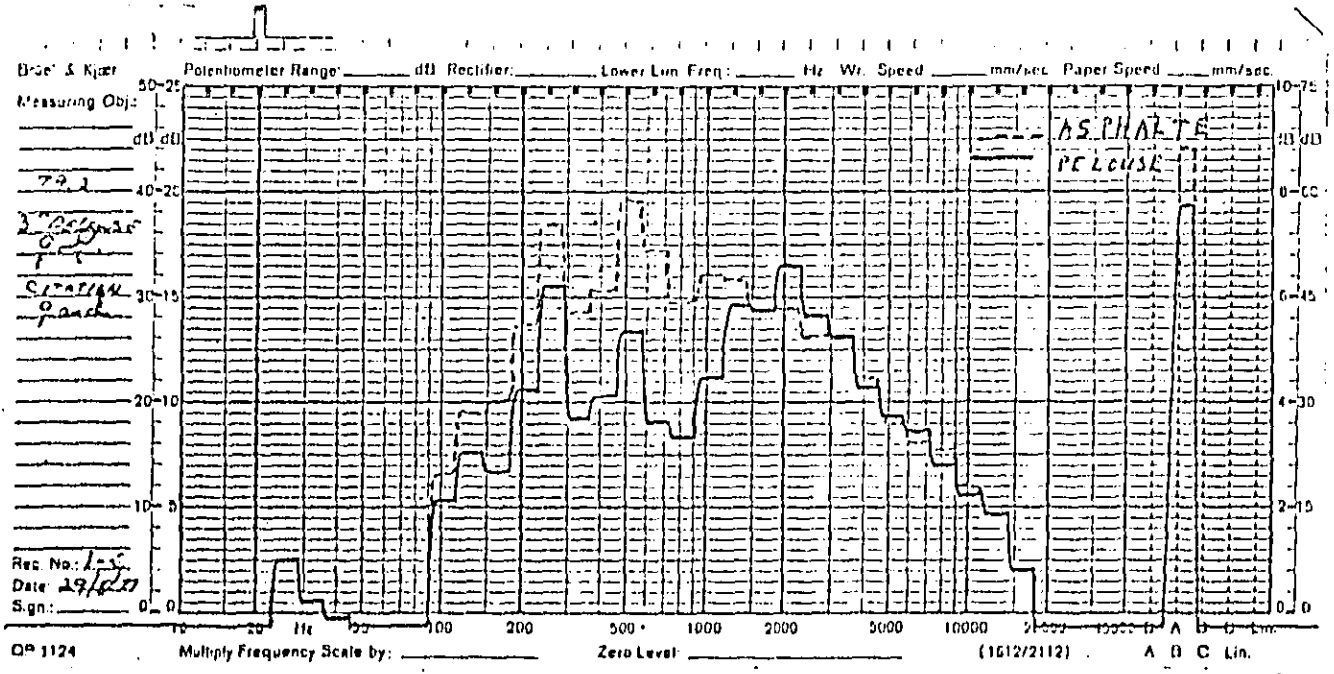



6/...

Let us go now with practical experience in the snow:

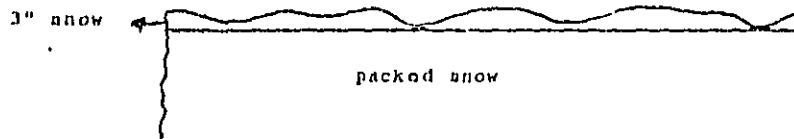

As we can see, distance from ground, reflexion incidence regarding the exhaust are not always the same. So?

And, remember in the snowmobiles trails it is much more often like that:



rather than in a straight line.

And a snowmobile is normally running on snow, so according to me you have to watch this situation very carefully.



7/...

Now speak of orientation of the output.

If you look at all sorts of mufflers on the market, you can have an output like:

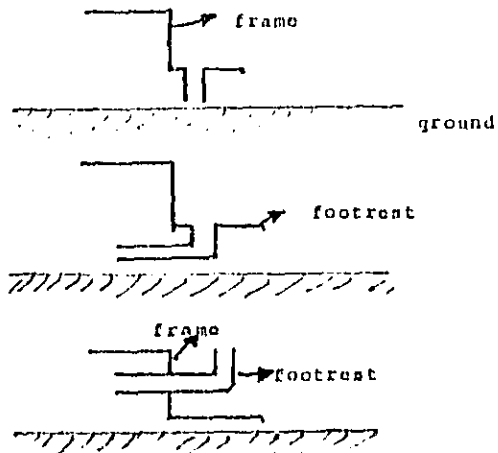

It is another factor that you have to consider.

For this we have made isosonic curves by having maximum HP/RPM on a static vehicle.

See slide no. 2



u/...

For finishing: sound direction related to speed.

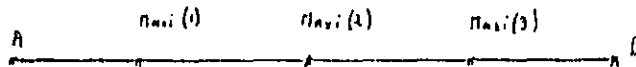

x Micro

See slide no. 3.

When you consider all other factors that we have talked about (temperature, pressure, snow, wind etc..) you can understand easily that if your vehicle is not at the same place because of different speed you are to be involved with a lot of difficulties. So you can have your maximum S.F.L. at (1), (2) or (3).

Consider also that the track depending on conditions of snow can spin all along the testing part or cannot spin. Of course the result will not be the same.



9/...

So, facing all these factors, we have tried to find an empirical formula which could be used of the major parts of what we have explained. We were interested in predicting the influence of any exhaust if set-up on any kind of vehicle in any kind of conditions.

For doing this we put on a vehicle sensors in order to get temperature of exhaust (near the end of the muffler), temperature and pressure at the spark plug, temperature of the air intake, RPM (measured at the drive pulley), real vehicle speed (measured at the driven pulley with appropriate correction for gearing), and of course we measured external temperature, humidity, pressure, wind and direction.

We also put coefficients for sort of packed snow, for thickness of packed snow, for sort of above snow, for thickness of above snow, for dry grass, for wet grass, for hard ground, for soft ground, for asphalt and also using isonomic curves for orientation effect.
Mixed track: asphalt and grass (or asphalt and snow).
See slide no. 4.



10/...

A statistical analysis has been done in order to find the influence of each parameters. We want to have something absolutely general with no particular test site conditions or particular muffler with a particular engine. This is going on right now. The first tries are not very good (± 5 dB(A)). We have to make some changes in factors to be considered and in the program itself.

Conclusion

This statistical approach has the advantage of being not very complicated and not very heavy in terms of dollars. It has the quality of being very near the field result that is to say, very near from what consumer people will really obtain. The results that we have obtained seem to confirm that it is quite difficult to predict field result with good correlation for snowmobiles.



11/...

INSTRUMENTATION USED:

Sound level meter BRUEL & KJAER #2204
FM recorder BRUEL & KJAER #7003
Low pass filter HP #5489a
Power supply HP #73a
WESTON voltmeter #4442
Electronic conditioner HP #5216a
Spectrum display HP #3720a
Correlator HP #3721a
Digital recorder HP #5055a
Statistical description analyzer BRUEL & KJAER #4420
Plotter X, Y HP #44a

BLACK COPY



Figure 1

BEST AVAILABLE COPY

BLACK COPY

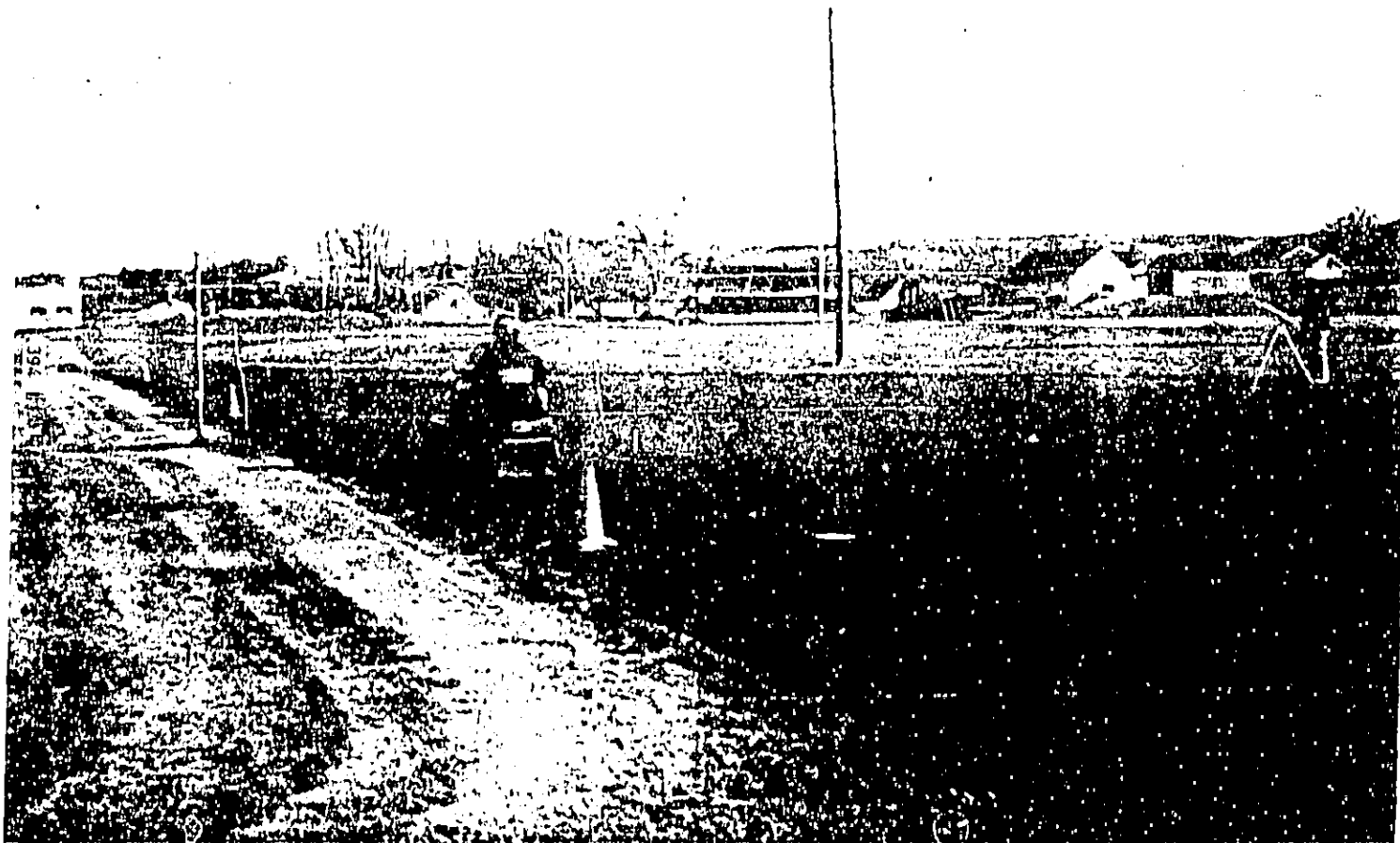

Figure 2

BLACK COPY



Figure 3

BLACK COPY

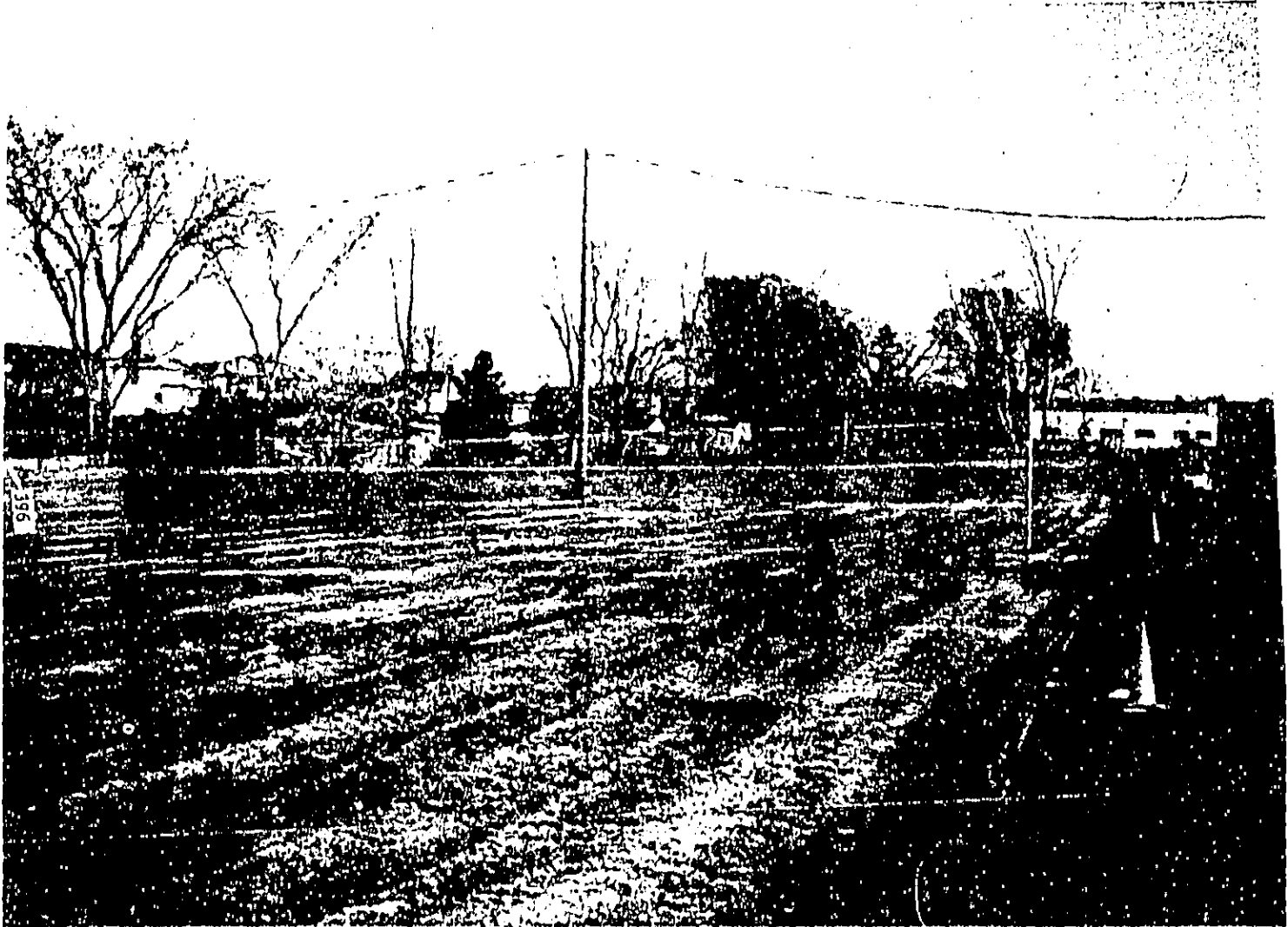

Figure 4

BEST AVAILABLE COPY

JOHN DEERE HORICON WORKS

220 EAST LAKE HORIZON WISCONSIN 53094

31 October 1977
JAMES W. MOORE



MEASUREMENT OF ENGINE EXHAUST NOISE IN DYNAMOMETER ROOMS

A method of measuring engine exhaust noise has been developed as a substitute for the more complicated anechoic room or field tests. It is simple and easy to use and does not require expensive test facilities and equipment or modifications to the exhaust system. The sound readings and insertion loss can be determined simultaneously with dynamometer power measurements. The results have shown good repeatability and are not subject to the variations in weather conditions encountered during field tests.

The test procedure was developed by Richard Kosteckí of ACS Engineering in Toronto, Canada and has been used successfully by ACS for exhaust system development for several years. A similar test method is also used by two other snowmobile manufacturers. John Deere has used it extensively in the development, comparison, and selection of snowmobile and small four cycle engine exhaust systems.

Figure 1 is a schematic diagram of the test system. The exhaust gas discharges from the muffler (1) into a 4-foot long, 2-inch diameter, flexible exhaust pipe (2) which is anchored at the loose end to a 60-pound steel block (5). The exhaust gasses can be evacuated from the test cell by the collector (6). The sound pressure is measured through a hole in the end of the pipe by a microphone (3) in a special water-cooled mounting (4).

The length and diameter of the flexible pipe were selected after extensive experimentation and are designed to isolate the microphone from the engine vibration and noise, and to provide adaptability to various exhaust system geometries. Engine performance and exhaust noise generation are not affected by the measurement system.

The sound level is read on a sound meter (7). Octave band measurements can also be taken (8). Correction factors are applied to each octave band to compensate for nonlinearities in the measurement system and for comparisons to field tests. This correction process is simplified by a spectrum equalizer (9).

JOHN DEERE HORICON WORKS

PAGE 2

A METHOD OF ENGINE EXHAUST NOISE MEASUREMENT IN DYNAMOMETER ROOMS

The upper curve in Figure 2 shows a typical exhaust noise spectrum of a snowmobile muffler measured on the test fixture. A correction factor is subtracted from each of the seven octave readings to extrapolate to the exhaust noise spectrum in the lower curve that would result from a snowmobile driveby sound test at 50 feet. The sum of the corrected octave bands produces the overall A-weighted level.

Figure 3 shows the spectrum of correction factors that are subtracted from each octave of exhaust noise measured on the test fixture. The upper curve is the difference between exhaust noise measurements made in an anechoic chamber and with the test fixture. It corrects the noise measured with the fixture to an A-weighted, "free field" sound level at a distance of 1 foot. (Narrow band measurements have shown that the frequency linearity of the measurement system is excellent within each octave band. A correction in the wider octave bands is all that is necessary to compensate for the nonlinear effect of the 4-foot long flexible pipe.) The middle curve converts the 1-foot measurement to 50 feet. The total correction is shown in the lower curve.

Figure 4 demonstrates how the 50-foot correction factor was developed. Octave bands of white, random noise produced by an acoustic driver were measured over a grass test site at a distance of 50 feet. The microphone was located 4 feet from the ground surface, and the sound source was placed at 1/8, 1/2, 1 and 2 feet above the ground. (The test site conformed to the requirements of "SAE J192, Sound Level Measurement Procedure for Snow Vehicles".) The variations in sound level with source height are caused by ground reflections (see SAE Publication 740211, "Effect of Ground On Near Horizontal Sound Propagation" by Piercy and Embleton). The 1/2-foot level, which is about the height of a snowmobile exhaust, provides the 50-foot correction factors shown in Figure 3.

Tests have shown that this exhaust noise measuring system gives sound levels within 2 dB of measurements made in an anechoic chamber. Correlation with the exhaust noise predicted in snowmobile passby tests is also excellent. The sound level difference between similar exhaust systems on the same engine or in the same vehicle can be compared within 1 dB. The convenience, repeatability, and simplicity of this method of exhaust noise measurement makes it very useful in small engine muffler development, selection and rating.

Noise measurements have not been attempted on exhaust systems other than those on small, two cycle and four cycle engines.

SCHEMATIC DIAGRAM

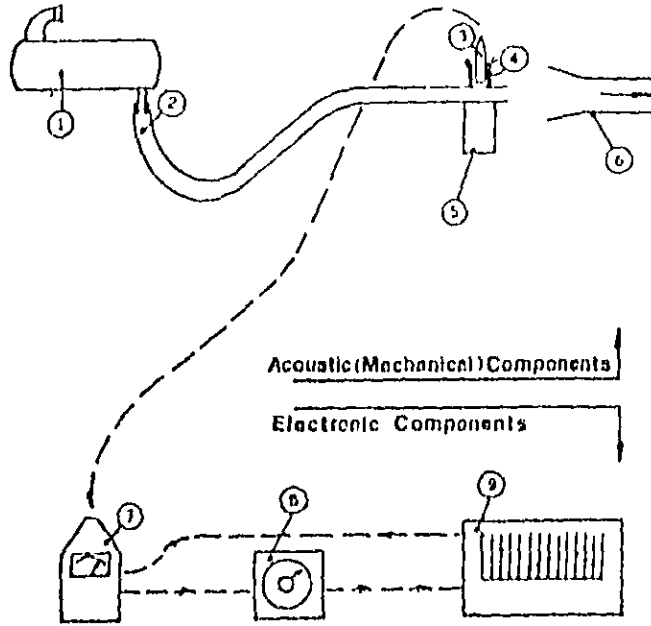
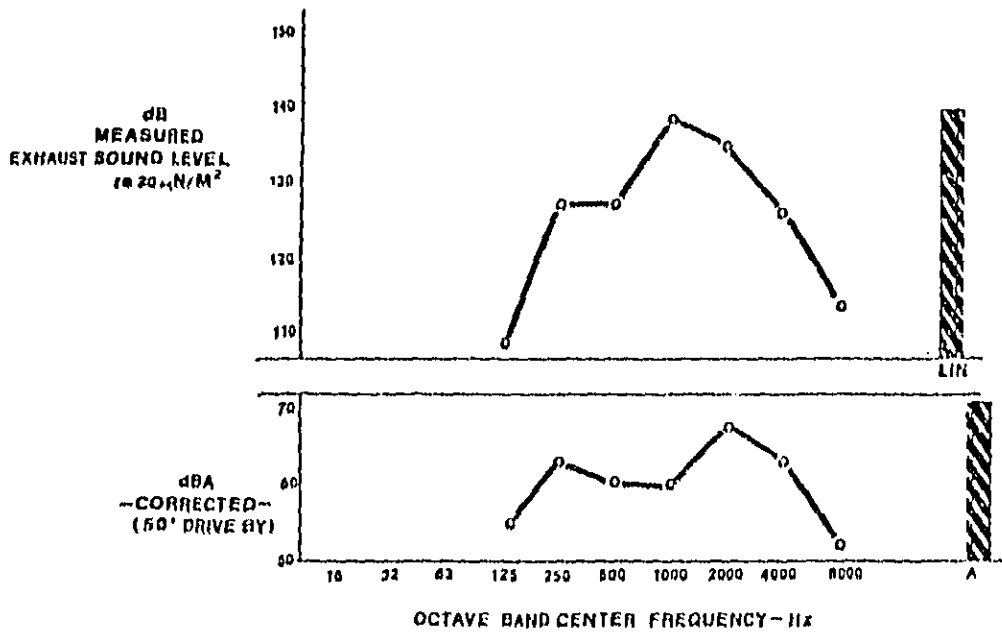

FIGURE 1



399 FIGURE 2

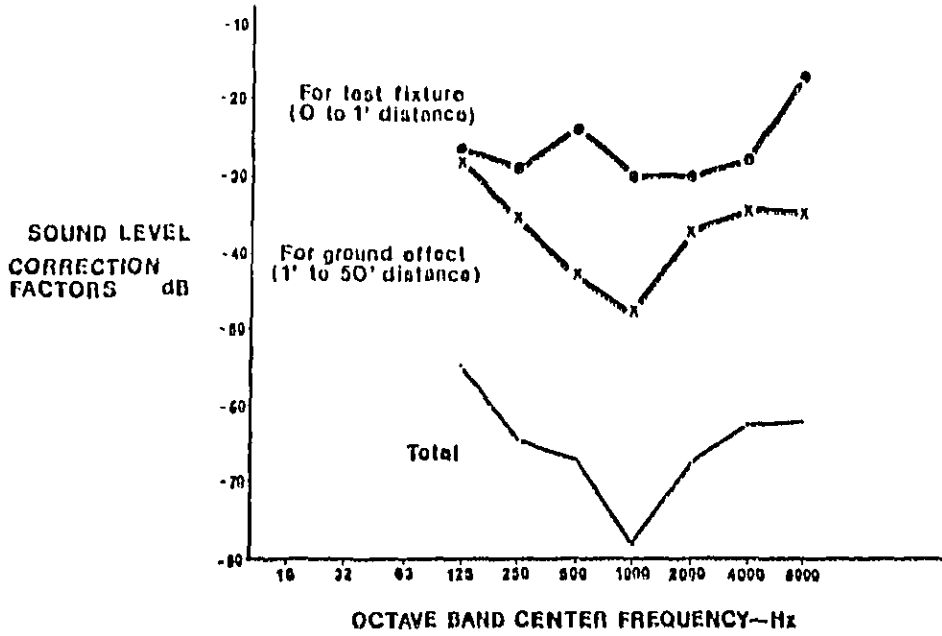
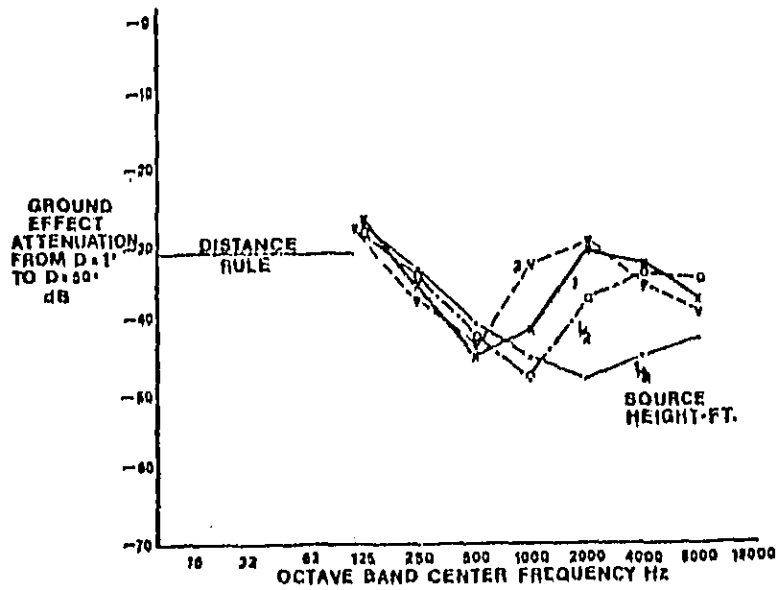

FIGURE 3



400 FIGURE 4

RECT AV/AR ADI E P/ANNU

THE APPLICATION OF THE FINITE ELEMENT METHOD
TO STUDYING THE PERFORMANCE OF REACTIVE &
DISSIPATIVE MUFFLERS WITH ZERO MEAN FLOW.

by

A. Craggs

Dept. of Mechanical Engineering
University of Alberta, Edmonton
Alberta, Canada.

INTRODUCTION:

This paper gives a brief review of some of work carried out by the author on the application of acoustic finite elements to studying muffler performance. It is shown that the method can give plausible results for a models having a simple geometry because the results compare very favourably with those obtained by other methods. Because the elements used in the work have a variable shape they can be used to simulate systems which might have a difficult geometry and still give meaningful information. This is one of the prime virtues of the method.

In two recent papers (1) and (2) it was shown that for transmission loss calculations the muffler has to be treated as one which has damping even when the muffler is a reactive one. This is because reactive mufflers lose energy through radiation at the inlet and exhaust parts. As such the equations which govern the motion of the system are expressed in terms of complex quantities. The general form of the equations are the same for both transmission loss and insertion loss calculations.

As the theory is available elsewhere (1) and (2) it is kept to a minimum in this presentation. However, the concept of an absorption element has not been used before and it is introduced here. These elements are particularly useful when dealing with absorptive boundaries having an extended reaction. A brief application of these elements is discussed at the end of the paper.

2.0 GENERAL THEORY

The application of the finite element method results in a set of linear equations. Because all of the situations are essentially for damped systems the problem has to be formulated in terms of complex quantities. However, using the method given in reference (1), the real and imaginary

parts can be separated and the system equations can be expressed entirely in terms of real quantities. When this is done, the equation for reactive and dissipative mufflers all have the general form shown below:

$$\begin{bmatrix} [A] - k^2[B] - k[C_I] & -k[C_R] \\ +k[C_R] & [A] - k^2[B] - k[C_I] \end{bmatrix} \begin{Bmatrix} P_R \\ P_I \end{Bmatrix} = \begin{Bmatrix} Q_R \\ Q_I \end{Bmatrix} \quad (1)$$

Here P_R is the real part of the acoustic pressure; P_I is the imaginary part; Q_R is the real source vector; Q_I the imaginary source vector; $[A]$ and $[B]$ are the kinetic energy and strain energy matrices respectively. The matrix $[C]$ is a dissipation matrix which only has non-zero elements at points corresponding to the boundary nodes where the energy is lost either through absorption as with mufflers having a dissipative lining or through radiation at the input and output parts as in a reactive muffler. In the general problem the matrix $[C]$ has the real and imaginary components $[C_R]$ and $[C_I]$.

Thus if we have a given sound source (Q) then the acoustic pressure at any point within the system may be found through matrix inversion, using standard computer subroutines.

2.1 TRANSMISSION LOSS CALCULATIONS:

The transmission loss refers to the performance of a muffler when it is inserted into an infinite transmission line. See Figure 1. The source is due to an incident progressive wave, of magnitude p^+ , which strikes the entrance of the muffler. The response then contains the reflected wave, p^- and the transmitted wave p_T , and pressures at numerous points inside. The transmission loss is calculated from the formula, (see references (1) and (2) :

$$T.L. = 20 \log \left| \frac{p^+}{p_T} \right|$$

Because of the infinite line there are no reflected waves either at the input of the output stations, and the impedance at these stations is accordingly entirely real; being equal to ρc , where ρ is the mass density of air and c is the speed of sound.

Transmission loss calculations are usually the first step carried out in the design of a muffler. However, because of the highly idealised situation which is applied some caution is needed when interpreting the

the results for a practical situation where reflected waves are present both on the input and output lines. A much more meaningful calculation is for the Insertion Loss.

2.2 INSERTION LOSS CALCULATIONS

The insertion loss refers to the difference in the sound intensity levels at a point before and after the insertion of the muffler. In general, then, two sets of calculations are required; one for calculating the response in the original situation and another for the situation including the muffler. The results will depend upon the nature of the source and the output radiation impedance. There is not a unique value for insertion loss and the result will clearly depend upon the individual case. Two different models are shown in Figure 1; one case Figure 1 (b) having a constant velocity piston source with the muffler terminated in an infinite transmission line and the other, Figure 1 (c), having a similar source, but being terminated into a half space through an infinite baffle. The finite element results for the transmission loss and insertion loss problems shown in figure 1 are discussed in a later section.

3.0 THE ACOUSTIC FINITE ELEMENT MODEL

The acoustic finite element used to obtain the results for this paper is shown in figure 2. It is a hexahedral element having 8 nodes and allows for a linear variation of pressure between the node points. Because the element is an isoparametric element it can be distorted to any reasonable shape. Therefore the use of this element enables problems having a difficult geometry to be treated. For the results given here only axi-symmetric cases were studied. With axi-symmetry, the three dimensional problem can be treated as a two dimensional one with a substantial reduction in the size of the problem. In this case the reduction in size was achieved by forming the hexahedron into a segment of a thick cylinder, then equating the pressures having equal radii and length coordinates. The element thus used has effectively 4 nodes instead of 8. (see reference 1).

A typical grid used for a simple expansion chamber model is shown in figure 3. Although this is quite crude compared with those required by many other finite element solutions the results obtained were quite accurate.

4.0 RESULTS

Most of the results given below are to validate the method. Many of these can be obtained from simple models of the system and they form a useful check on the procedure. This is particularly true for reactive mufflers when it can be assumed that acoustics within the expansion chamber is strictly plane-wave and thus one dimensional. However, the plane wave solution breaks down when the wavelength approaches the chamber diameter. It is then that the finite element model shows a distinct advantage.

Results are discussed in turn for reactive mufflers, dissipative mufflers with a locally reacting boundary and finally for lined mufflers with extended reaction at the boundaries. The extended reaction is modelled by extending the finite element approach to an absorptive material and then forming an acoustic-absorption model.

4.1 REACTIVE MUFFLERS: TRANSMISSION LOSS

The transmission loss of a simple expansion chamber in terms of the area expansion ratio, m , length l and wave number k is given by a formula due to Davis (3) :

$$T.L. = 10 \log_{10} (1 + 1/4(m - 1/m)^2 \sin^2 kl)$$

The finite element results are compared with those obtained from this formula in figure 4. There is excellent agreement. Further results corresponding to higher frequencies are given in reference (1), they show that when diametral modes are excited they can either act as passing filters and thus reduce the transmission loss or as blocking modes.

Figure (5) show the effects of extended inlet and outlet pipes within the chamber. These act as quarter-wavelength filters which give high transmission-loss values whenever the length of the extended pipe, l_e , is given by $Kl_e = n\pi/4$, when n is any odd integer. The finite element results show this to be the case.

4.1 INSERTION LOSS

Figure (6) compares the transmission loss results with the insertion losses calculated for the two situations shown in figure 1. There is an enormous difference and in one case, where the muffler is terminated into a semi-infinite space the insertion loss shows negative values, thus the muffler is enhancing the sound, where transmission loss calculations would indi-

cate a substantial reduction.

4.2 DISSIPATIVE MUFFLERS : LOCALLY REACTING BOUNDARIES

The calculation of the transmission loss for an expansion chamber having a cylindrical absorptive lining is not a simple matter, although design procedures do exist. See Beranek (4). It can be handled with a finite element model by solving the general equations given in equation 1. When an absorptive lining exists the terms in $[C_I]$ and $[C_R]$ are non-zero at points corresponding to the boundary nodes where the liner is attached. The terms in $[C_I]$ and $[C_R]$ depend upon the form of the liner impedance. In this model, the liner was assumed to be locally reacting with the impedances given by the empirical equations developed by Delany and Bazley (5). See also reference (2). These equations allowed for a semi-rigid porous material in which the characteristic impedance was a function of the materials resistivity. The impedance for any thickness was then calculated by assuming that the outer end of the layer was attached to a rigid layer.

Results for the transmission loss are shown in figure 6, these show the changes which occur when the thickness of the liner is increased. With a thin liner, there is little change from the unlined reactive case. As the thickness increases, the multiple hump transmission loss characteristic of the reactive muffler is replaced by a single hump which has a maximum when the thickness of the liner is 'approximately equal' to a quarter wavelength. Thus the maximum value occurs at lower frequencies as the thickness is increased.

However, there comes a point when the thickness is too great and the magnitude of the reflected wave from the hard boundary is small, in which case the boundary impedance of the liner approaches the characteristic impedance of the liner material and no further changes in the transmission loss occur.

DISSIPATIVE MUFFLERS WITH EXTENDED REACTION

An improved model of the acoustic lining is obtained if the assumption that the boundary is locally reacting is removed. In order to achieve this an acoustic absorption element has been developed based on a Rayleigh model for a rigid-porous material. This element is again hexahedral in form and is entirely compatible with the previously mentioned acoustic

element. The general form of the response within the medium is again governed by an equation similar to (1), the differences with the acoustic equation being found in the matrix[C]. For the absorption equations this matrix is now fully populated and the magnitude of the terms are proportional to the resistivity of the material. Further, details of this element are to be published in reference (6).

The absorption elements can be joined to acoustic elements by equating the pressures at the common node points. A typical axi-symmetric model is shown in Figure 7; this represents a cylindrical expansion chamber with a thick lining. Results for such a chamber are also shown. When the resistivity $R = 0$, the model is then of a simple reactive chamber and the transmission loss has the typical "squared sine wave" appearance. The lining greatly increases the transmission loss when the resistivity $R = 10,000$ Rayls/metre. Although experiments need to be carried out to verify the results, the general form of the curve is in agreement with those obtained from lined duct silencers used in ventilating systems.

COMMENTS.

The use of acoustic finite elements for modelling silencer systems has been described. The method at this stage is particularly valuable when difficult geometries are to be simulated and for predicting the performance at high frequencies when the wavelength approaches the diameter of the expansion chamber and one dimensional theories no longer apply. It is also useful for modelling dissipative liners either with, locally reacting model in which there is no substantial increase in the size of the matrices compared with the reactive case or with absorption elements. The method can easily be applied to Transmission Loss or Insertion Loss calculations.

The contents of this paper are mainly concerned with the work of the author. However, the method has been applied to mufflers by other authors with some success. Young and Crocker (8) calculated the transmission loss of an expansion chamber using rectangular elements. Kagawa and Omote (9) considered reactive mufflers using axi-symmetric ring elements and later Kagawa, Yamabuchi and Mori (10) considered the transmission loss of a muffler with a sound absorbing wall.

REFERENCES

- (1) A. Craggs 1976 "A Finite element method for damped acoustic systems; an application to evaluate the performance of reactive mufflers." *Journal of Sound & Vibration* (48) (3) p. 377-392
- (2) A. Craggs A 1977 "A Finite element method for modelling dissipative mufflers with a locally reactive lining." *Journal of Sound & Vibration* 54 (2) p. 285-296
- (3) D.D. Davis Jr. 1975 in *Handbook of Noise Control*, C.M. Harris (editor) New York : McGraw-Hill Book Company Inc. Acoustical Filters and Mufflers. Chapter 21.
- (4) L. Beranek 1971 *Noise and Vibration Control* New York, McGraw-Hill Book Co.
- (5) M.E. Delany and E.N. Bazley 1970 *Applied Acoustics* 3 105-116. Acoustic properties of fibrous absorbent materials.
- (6) A. Craggs A Finite Element Model for Rigid Porous Absorbing Materials to be published.
- (7) C.I.J. Young and M.J. Crocker 1975. *Journal of the Acoustical Society of America* 57 p 144-148. Prediction of the Transmission Loss in Mufflers using the finite element method
- (8) Y. Kagawa and T. Omote 1976. "Finite Element Simulation of Acoustic Filters of Arbitrary Profile with Circular Cross Section." *Journal of Acoustic Society Am.* 60 (5) p. 1003-1013
- (9) Y. Kagawa, T. Yamabuchi and A. Mori. 197 "Finite Element Simulation of Axi-Symmetric Acoustic Transmission System with a Sound Absorbing Wall. *Journal of Sound & Vibration*

Figure Captions

- Figure 1 Models for Transmission Loss and Insertion Loss calculations.
(a) Transmission Loss (b) Insertion Loss ; Constant Velocity source terminated in an infinite line (c) Insertion Loss Constant velocity source terminated infinite baffle.
- Figure 2 The eight node isoparametric hexahedral element.
- Figure 3 Two-dimension grid for an axi-symmetric expansion chamber model.
- Figure 4 Transmission Loss. Comparison of finite element results with exact one dimensional solution at different expansion ratios m .
- Figure 5 Finite Element results for the effect of extended inlet and outlet pipes.
- Figure 6 Comparison of Transmission Loss with Insertion Loss. Finite element results. See Figure 1.
- Figure 7 Transmission Loss for Expansion chamber with a cylindrical absorbent lining. Impedance calculated using Delany & Bazley equations. Figure shows effect of lining thickness. ($m=a$)
- Figure 8 (a) The Axi-symmetric Acoustic-Absorbent finite element grid.
(b) Transmission-Loss with and without any absorption.

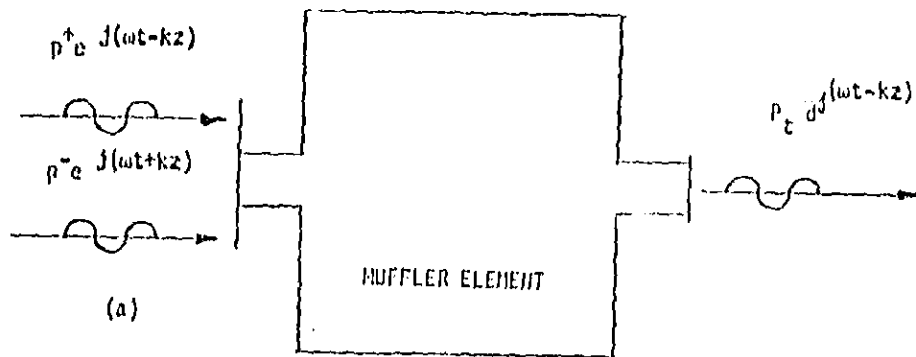

(a)

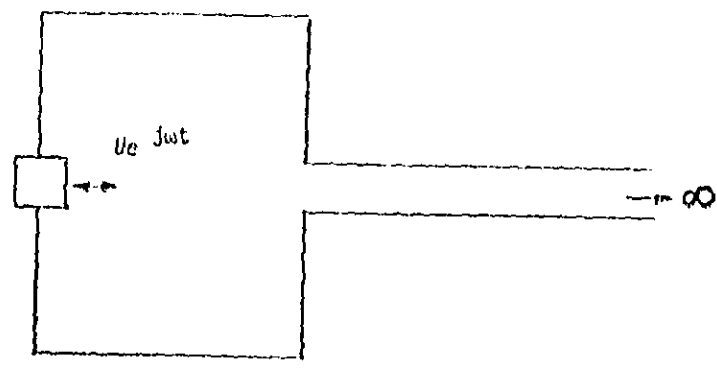

(b)

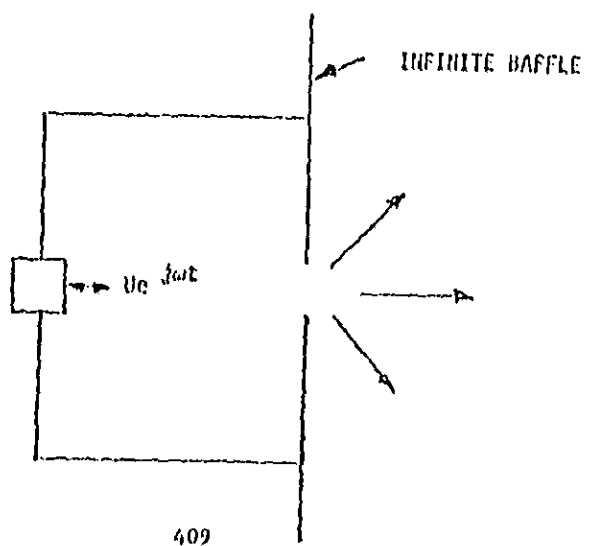

(c)

Figure 1

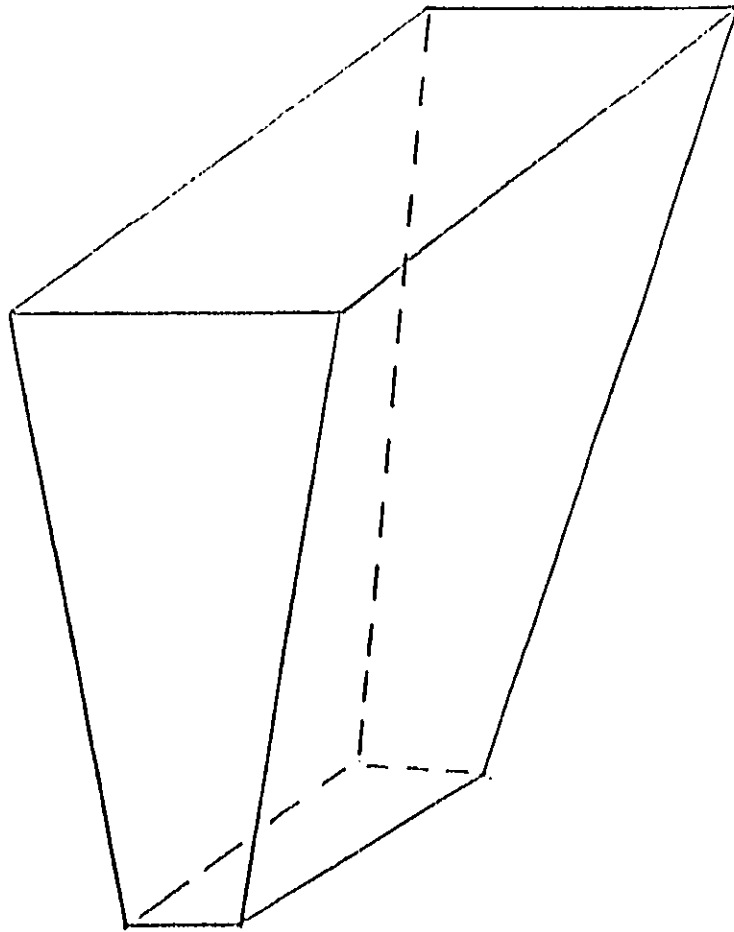

20 NODE ISOPARAMETRIC
ACOUSTIC ELEMENT

Figure 2

SECRET AVALIABLE TO THE PUBLIC

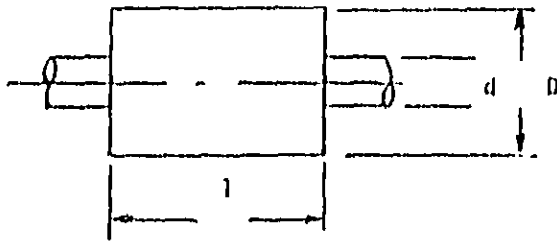
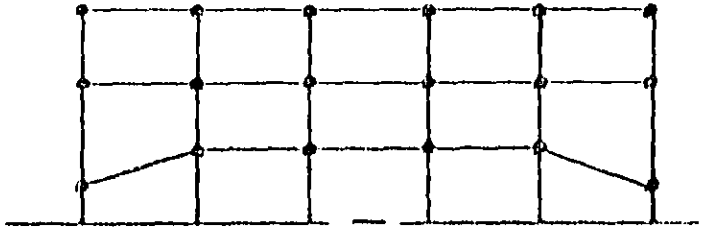

Figure 3

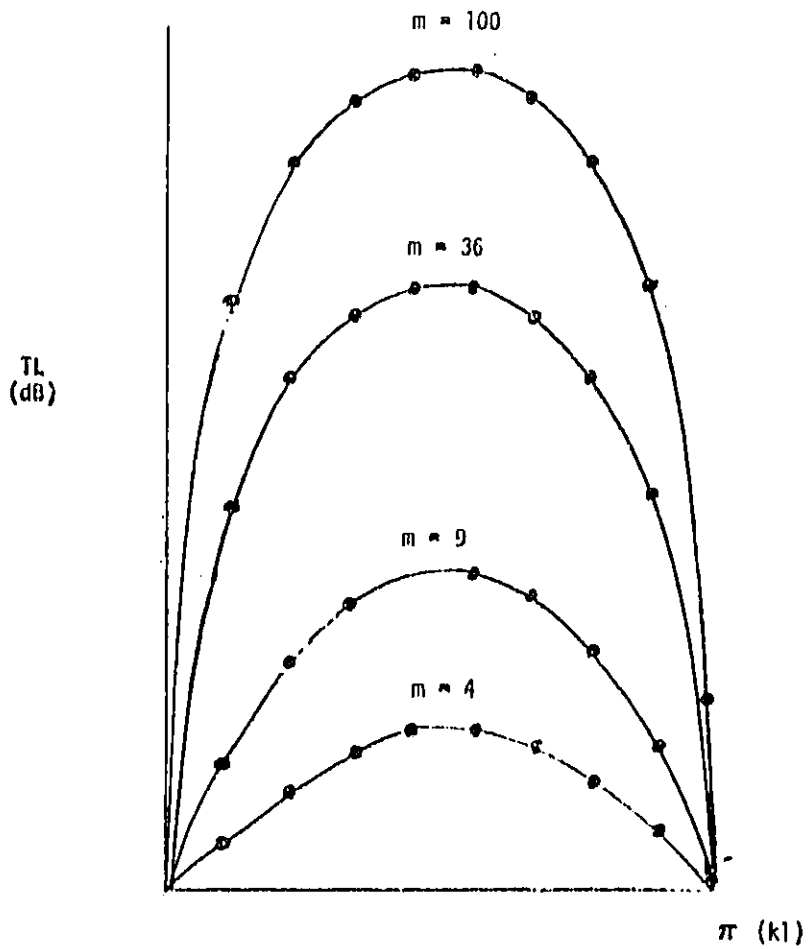
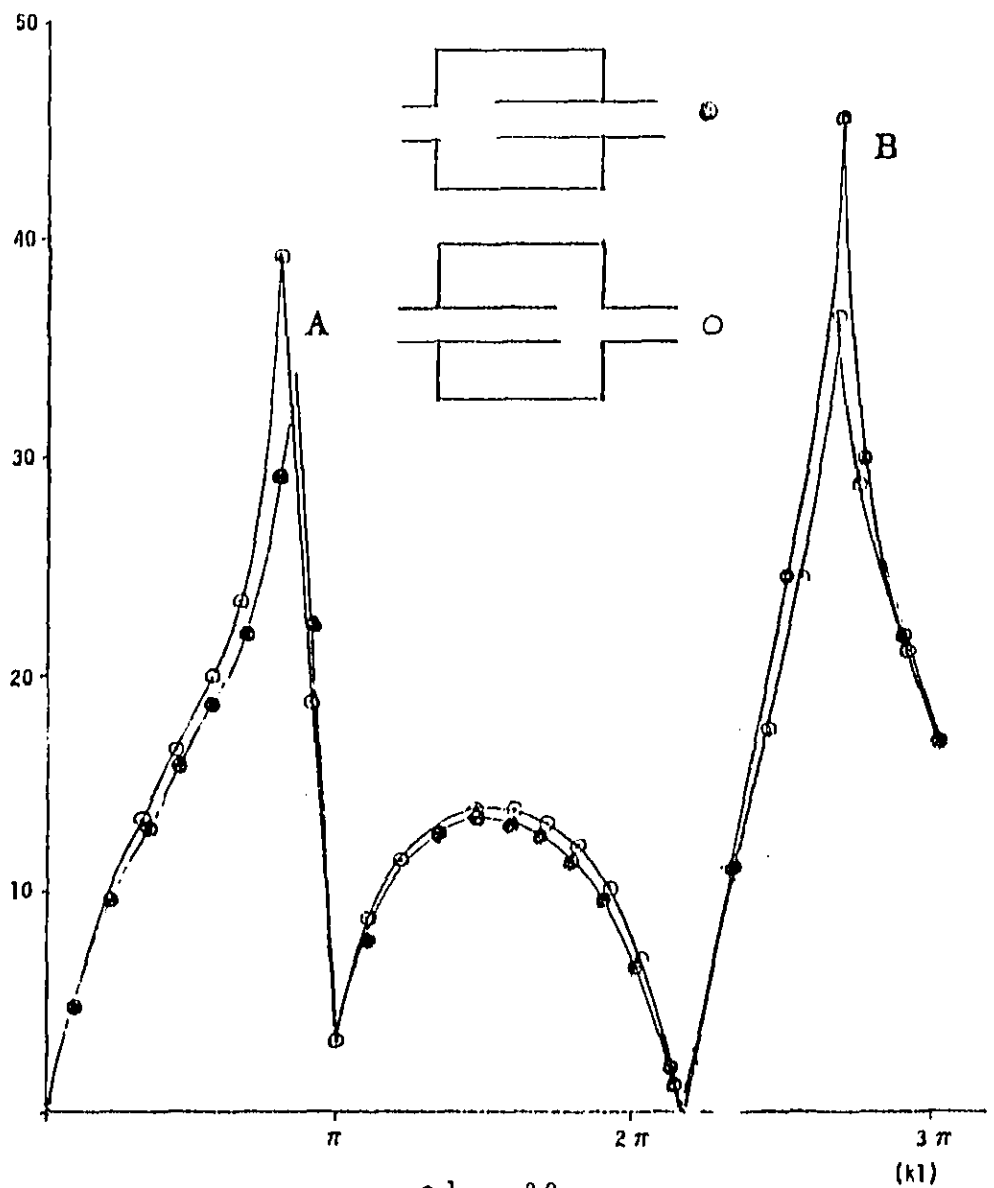

Figure 4



- $l/h_1 = 0.0$
- $l/h_1 = 0.6$

Figure 5
413

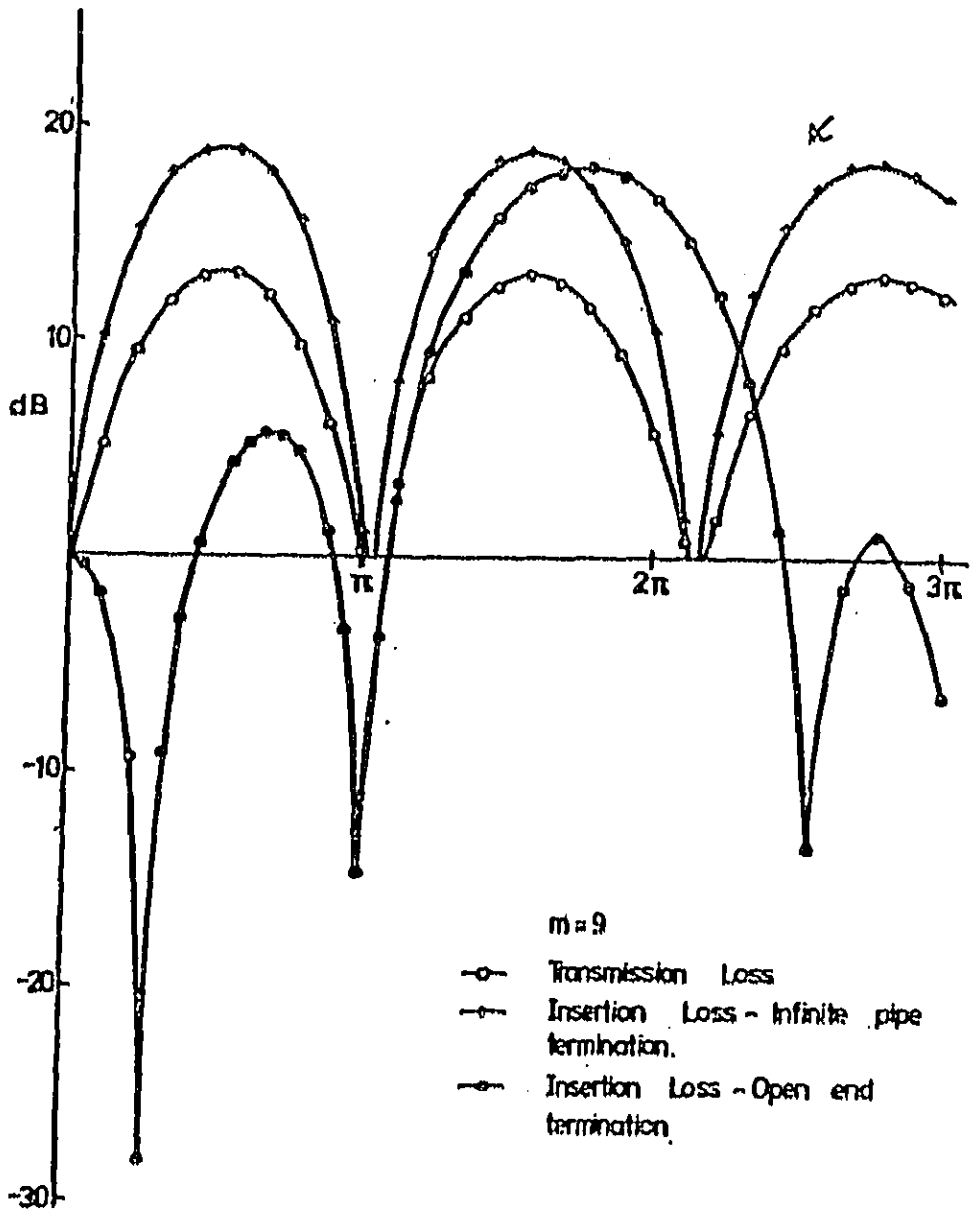

Figure 6

DCOT A1418 8312 00000

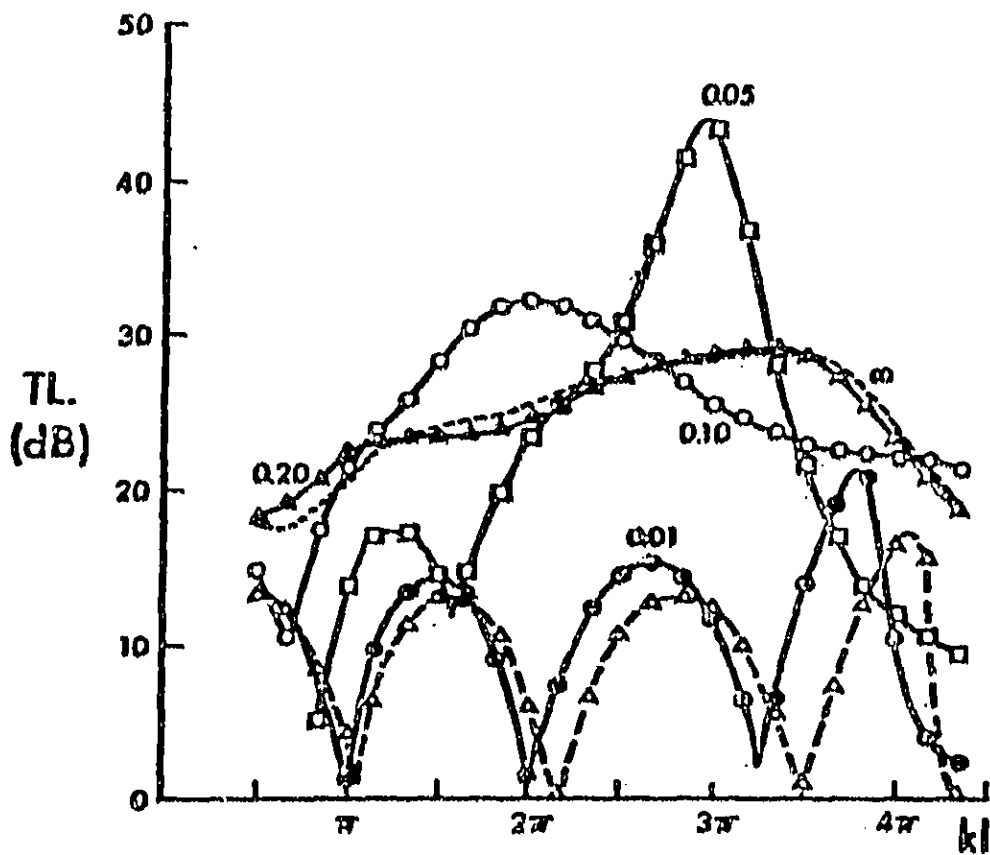
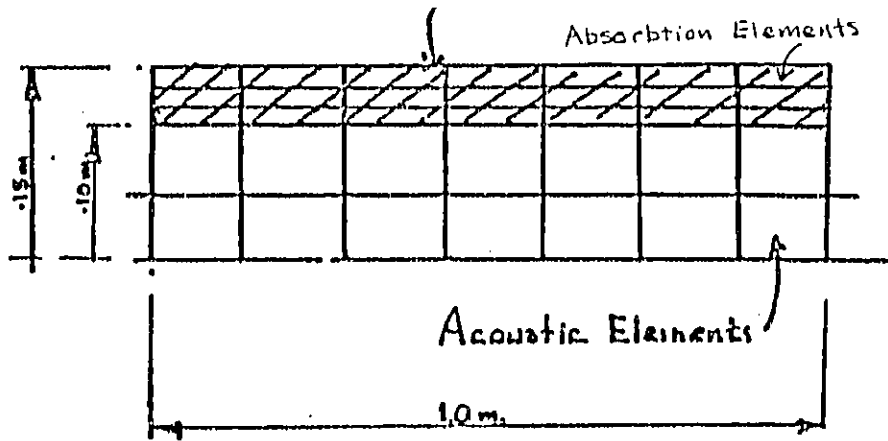
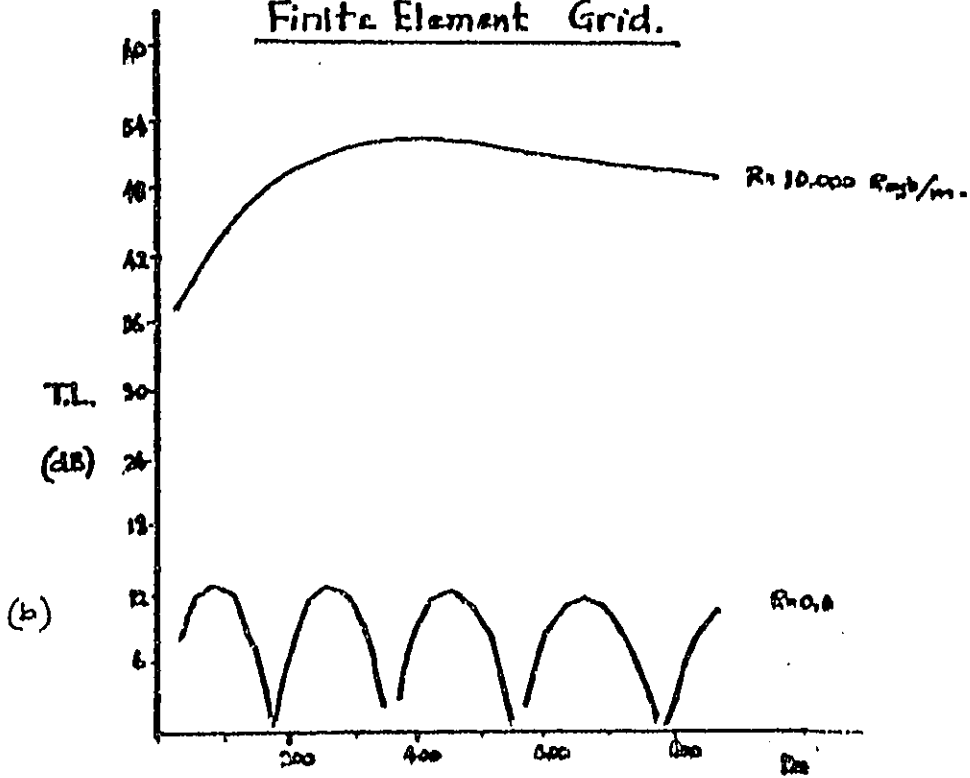

Figure 7



Acoustic - Absorption

Finite Element Grid.



416 Figure B

A COMPARISON OF STATIC VS. DYNAMIC
TESTING PROCEDURES FOR MUFFLER EVALUATION

W. L. Ronci
10/21/77

INTRODUCTION:

For the past ten years, Original Equipment exhaust systems have been designed to meet the requirements of SAE Test Procedure J986a. J986a was the first noise test standard for light vehicles in this country. The original development work on the procedure was done in early 1966. The standard was first applied to new vehicles in 1967 and was revised to its current version in 1968.

SAE Test Procedure J986a formed the basis for the so-called California Passby Test. The California Passby Test is required under California Vehicle Code 27160, for new motor vehicles under 6,000# gross vehicle weight. The code first became effective in 1968. It has been revised twice since, first in 1972 and again in 1973, when the current version became effective. The California Passby Test procedure is defined under Title 13, of the California Administrative Code.

A detailed comparison of the California Passby Test and the J986a Passby Test will disclose that there are differences between the two procedures. In actual practice the differences are minor. Test results obtained by the two procedures correlate extremely well. Walker uses the SAE procedure as specified by their Original Equipment customers.

J986a TEST PROCEDURE

To conduct the test, a sound level meter microphone is placed 50 feet off to the side from the center line of vehicle travel as shown in Figure 1. The microphone is located four feet above the test surface. The procedure calls for a flat open area, free from obstructions for a distance of 100 feet in all directions.

Under the procedure, the test vehicle approaches the test section at a steady state speed of 30 MPH. When the vehicle reaches 25 feet from the test point, it is accelerated at wide open throttle. The lowest gear ratio is used which will permit at least 50 feet of accelerating distance without over speeding the engine. Passbys are made under these conditions in both directions and the maximum observed total sound pressure level for each passby is recorded. The average of the two highest observations within two dB of each other is reported as the test value for the vehicle. The test results are reported for the noisier side of the vehicle.

It should be emphasized that the California Passby Test regulated only new vehicles sold in that state. It did not regulate existing vehicles. Nor did it regulate the replacement of noise-producing or noise-silencing components, nor of vehicle modifications which increase the total vehicle noise.

20" STATIC TEST PROCEDURE

Accordingly, the 1971 session of the California Legislature enacted Vehicle Code 23130 which regulates aftermarket replacement exhaust systems. The Commissioner of the California Highway Patrol was directed to conduct a study to define procedures and standards by which exhaust systems could be certified as meeting the established allowable total vehicle noise levels. The California Highway Patrol commissioned the McDonnell Douglas Company to develop a certification program, stationary test methodology and related law enforcement techniques. The study formed the basis for the regulations promulgated in November of '75 under Title 13 of the California Administrative Code.

The test procedure adopted in the code was the so-called California 20" static test. The choice of a static test procedure was based in large measure on the ineffectiveness of the driveby test procedure in urban areas. The coverage attainable using the driveby test in urban areas was limited because of the lack of suitable enforcement sites with sufficient open area and low ambient noise levels. The passby test was more appropriate to rural highways or freeways. Moreover, being a total vehicle noise test, it was unsuitable for regulating replacement mufflers. There was no simple enforcement means to ensure that a cited vehicle was subsequently made legal.

The 20" Static Test Procedure specifies that the test be conducted on an outdoor pavement or on a shop floor. A clear open area around the test site of only ten feet is required. The microphone location is dependent upon the tailpipe routing as shown in Figure 2. Typically it is located 20" from the end of the tailpipe, 45° off-axis, at the height of the tailpipe exit. The procedure calls for operation of the vehicle, after a suitable warmup, at 3/4 of rated RPM, with the transmission in neutral. The value reported for the exhaust system is the highest reading obtained, disregarding extraneous peaks.

CORRELATION STUDY

With the addition of a 20" Static Test Procedure which was to become effective January 1, 1977, it was evident that the potential existed for a dual design standard for exhaust system development. Accordingly, Walker set about to determine whether there was sufficient correlation between the two test methods to permit the prediction of static test performance based on driveby tests, which were currently being conducted for Original Equipment product. The prime motivation for this was to reduce the total engineering test load and to establish a single acoustic design and acceptance test criteria. Data was taken on a variety of new vehicles. A representative mixture of four, six, and eight cylinder passenger cars were used in the tests.

A number of different types of mufflers were tested. These included the Original Equipment systems, with which the new vehicles came equipped. The Original Equipment system sometimes incorporates a smaller muffler or resonator. The system is usually made up on one or more assemblies, with the pipe welded to the muffler. Figure 3 shows a typical example of an OE system assembly. Welded assemblies are used to minimize the installation labor in the car factories. The O.E. system is designed to meet both the objective requirements of J986a and the particular car company's subjective sound quality as it relates to the image of the vehicle in question.

Walker's regular aftermarket mufflers and resonators were also tested. Regular mufflers and resonators are sold as separate units with the system held together by clamps. Figure 4 shows a cut-away view of a typical regular aftermarket muffler. Walker follows the practice, which is common in the replacement exhaust system industry, of consolidating a number of Original Equipment designs into one aftermarket design in order to achieve some economies of scale in production and to minimize the stocking and inventory problems that would otherwise exist. Walker's, indeed the industry's, ability to provide the consumer with an economically priced replacement part, on a moment's notice, is heavily dependent upon its ability to consolidate O.E. Designs.

The construction techniques and acoustic design techniques of Walker's regular muffler line is quite similar to the Original Equipment. Figure 5 shows a cut-away view of an OE design for comparison. The subjective sound quality of the regular line conforms to Walker's own corporate standards for preserving the Original Equipment image of the vehicle. A Cadillac owner expects his vehicle to sound like a Cadillac; a Corvette, like a Corvette.

Also included in the tests were Walker's WACO mufflers. These are a highly consolidated line for certain customers such as K-Mart and Montgomery-Ward. The line is built to the same high quality and construction standards as the regular line. Bushing adapters are used to accommodate a wider variety of applications. On average they are slightly smaller in size than the regular aftermarket muffler or the Original Equipment design which they replace. Figure 6 shows a cut-away view of a typical WACO unit.

Walker's Unitized line was tested as well. The Unitized muffler is a 4" round tubular design with swaged ends. This line has a reasonably high degree of consolidation. Generally it uses a "Tri-flow" acoustic design (See Figure 7) and is not as efficient at the low frequencies because of the smaller physical volume. Single and double tuned resonators are not used. The Unitized line was introduced to satisfy the needs of car owners with older vehicles, who are interested in economy.

The fifth type of muffler included in the tests were glass packs. Walker's glass packs also employ a 4" round construction with swaged ends. In external appearance they look very much like a Unitized muffler. Acoustically they are quite different. They employ a straight thru design with a concentric perforated tube surrounded by fiberglass, as shown in Figure 8. The design is effective at absorbing high frequencies and is characterized by a throaty, straight-thru sound quality. Generally it is both objectively and subjectively louder than the other lines.

In total 305 systems were tested using both the 20" static test procedure and the J986a passby method. Fifty-nine Original Equipment systems were evaluated along with 110 regular mufflers, 50 WACO units and a combined total of 86 Unitized and glass pack versions.

ANALYSIS OF RESULTS

The test data was analyzed using standard computer statistical techniques. The data was examined in a variety of ways. Simple statistics were determined for each test method and each class of muffler system; that is, the mean, the range and the standard deviation. The simple statistics, while not very informative, are presented in Tables 1 and 2.

Each class of muffler and the total population were subjected to a correlation analysis from which the correlation coefficient was determined. A correlation coefficient of one means a one-to-one correspondence between the two test methods. A correlation coefficient of 0 indicates a totally random relationship between the two tests. The results of the correlation analysis are shown in Table 3. It is evident that there is no significant correlation between the two. The data was also subjected to a regression analysis. From this, a best, least-squares relationship between the two test methods was established. The lack of correlation is very evident from the scatter diagrams shown in Figures 9 thru 13. It can be seen that the predictive accuracy of the J986a test is about ± 20 to 30 dbA.

From the analysis it is apparent that there are different acceptance criteria required for O.E. and aftermarket product. It is evident one cannot eliminate the need for running both tests. It was also evident that potentially different design approaches would be required for aftermarket and O.E. product.

It appeared that the internal construction of the muffler affects the relationship between the test results obtained by the two methods. This is apparent from the different correlation coefficients for the regular, WACO and Unitized mufflers configurations. The increased correlation shown by the Unitized and glass pack mufflers was probably attributable to the lack of some low frequency

tuning elements in these designs, and to the presence of a larger component of exhaust noise in the passby test.

The test results lend credence to another set of conclusions that can be reached about the process by which the two California laws were developed. A new vehicle law was passed first, which regulated total vehicle noise without defining what the exhaust system contribution to it would be, and without adequate provisions as to how exhaust noise would be regulated on older vehicles. Next an aftermarket law was passed to regulate exhaust systems. The end result is two standards of acceptance of exhaust systems which bear little relationship to each other. Perhaps this could have been avoided had both O.E. and aftermarket been considered together from the start.

These light vehicle standards have now been adopted almost without change by the state of Florida and are being followed with interest by the state of Oregon. The ultimate impact of these tests on the industry's ability to continue the important practice of consolidation is not yet fully known.

The federal government is presently developing a new set of acceptance criteria for passenger cars. This one will probably be based on a totally different passby test. We have been meeting here the last few days to discuss yet another criteria, this one a bench test suitable for labeling exhaust system replacement parts. The question of correlation between these two federal test methodologies should be considered from the onset in their development.

The importance of considering the impact of these new regulations on the industry's ability to consolidate Original Equipment designs cannot be overemphasized. Should the industry lose this ability and the number of replacement parts proliferate, the result would be increased engineering costs, shorter production runs, increased warehousing space and higher inventory costs. The end result of all that will certainly be higher prices to the consumer and potentially, delays on the part of the installer in finding a replacement part for his customer's vehicle.

Basic Site Layout
J-986a Passby Test

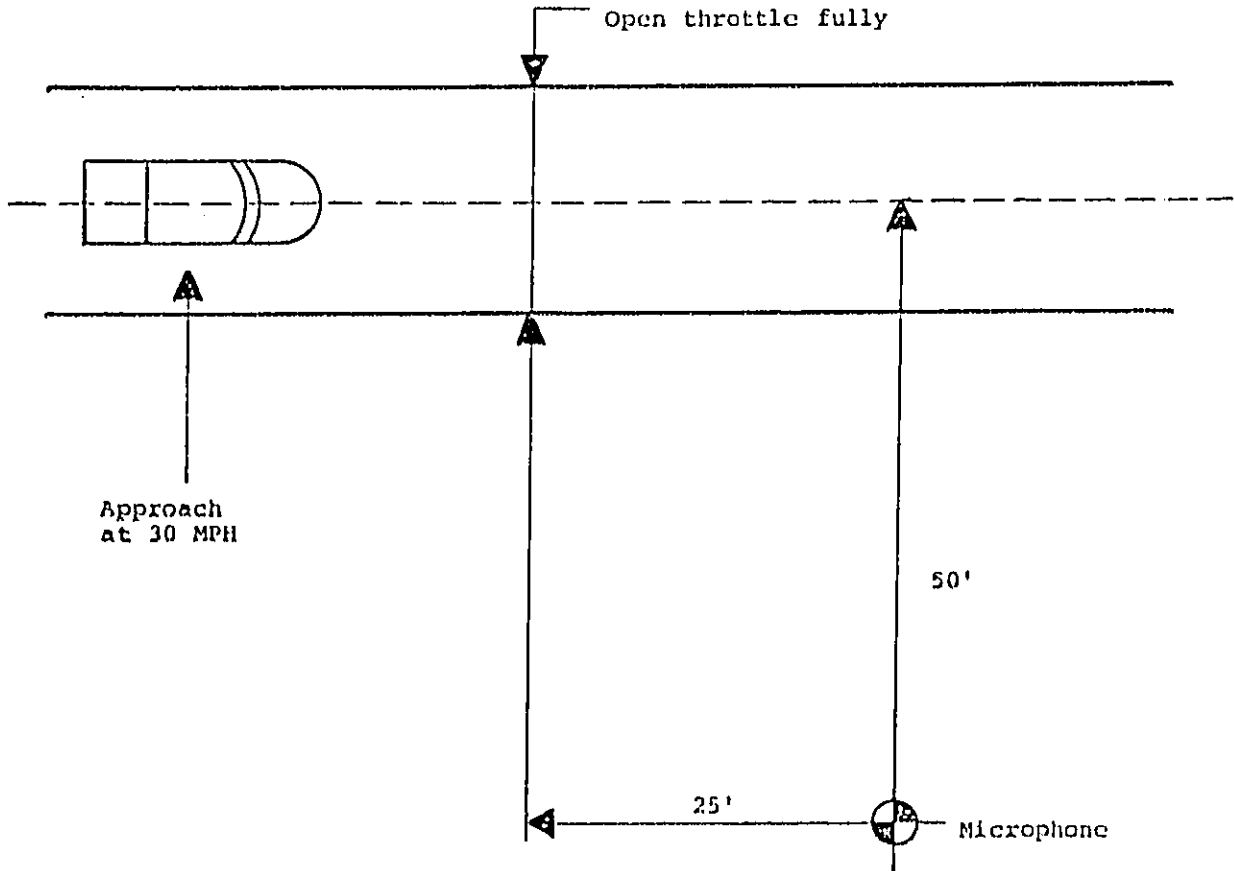
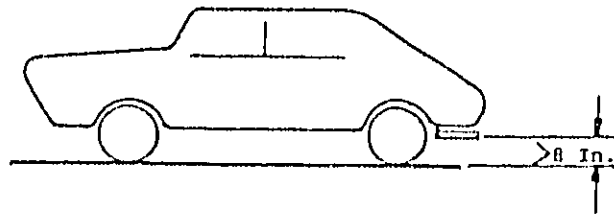
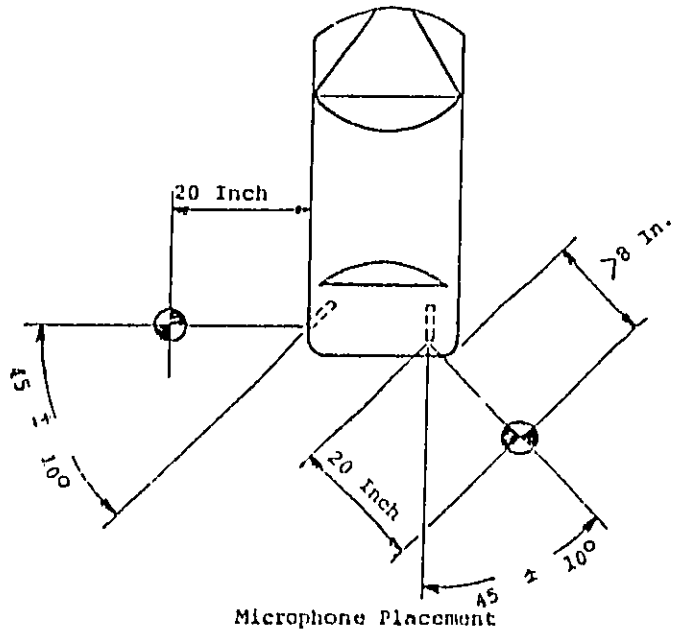

Figure 1

423



Microphone Height
20" Static Test Layout - Figure 2

<u>Muffler Type</u>	<u>Mean Value</u>	<u>Standard Deviation</u>	<u>Range</u>	
			<u>Lo</u>	<u>Hi</u>
O.E.	76.6	3.2	71.7	87.8
Regular	77.8	3.5	71.2	88.2
WACO	80.8	3.2	74.4	88.2
Unitized & Glass Pack	80.7	4.1	73.3	94.0
Total Composite	78.8	4.0	71.2	94.0

J-986a Test Results

Table 1

<u>Muffler Type</u>	<u>Mean Value</u>	<u>Standard Deviation</u>	<u>Range</u>	
			<u>Lo</u>	<u>Hi</u>
O.E.	84.4	3.6	78.1	92.1
Regular	85.4	4.5	78.2	95.8
WACO	86.6	4.3	79.0	96.9
Unitized & Glass Pack	92.2	5.3	82.6	105.4
Total Composite	87.3	5.5	78.1	105.4

20" Static Test Results

Table 2

<u>Muffler Type</u>	<u>Correlation Coefficient</u>	<u>No. of Observations</u>
O.E.	.245	59
Regular	.333	110
WACO	.282	50
Unitized & Glass Pack	.451	86
Total Composite	.462	305

Correlation Analysis Results

Table 3

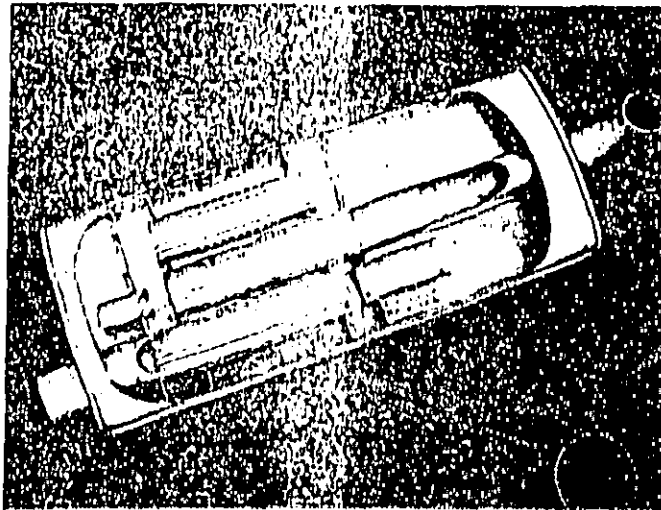

Typical Original Equipment Exhaust System
Figure 3

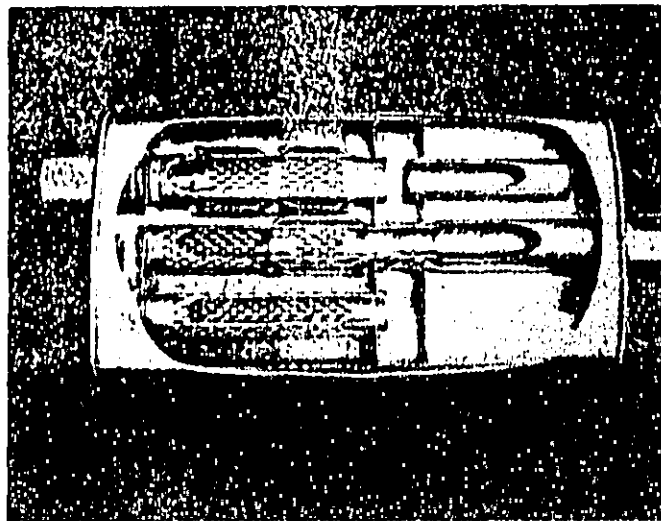

Cutaway View - Regular Aftermarket Muffler
Figure 4

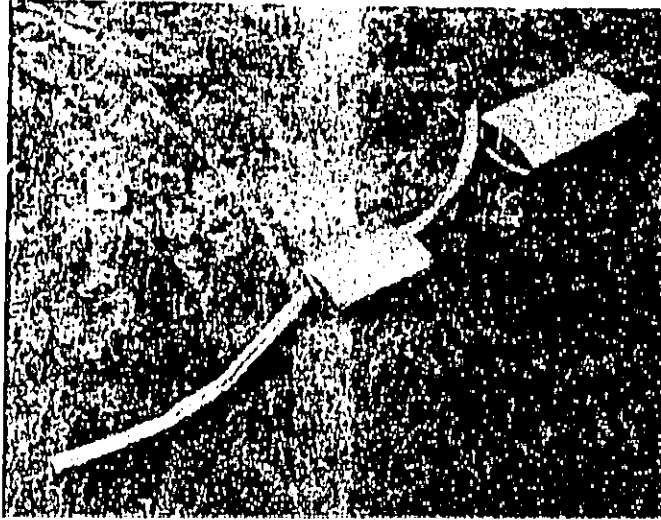

Cut-away View - Typical OE Muffler
Figure 5

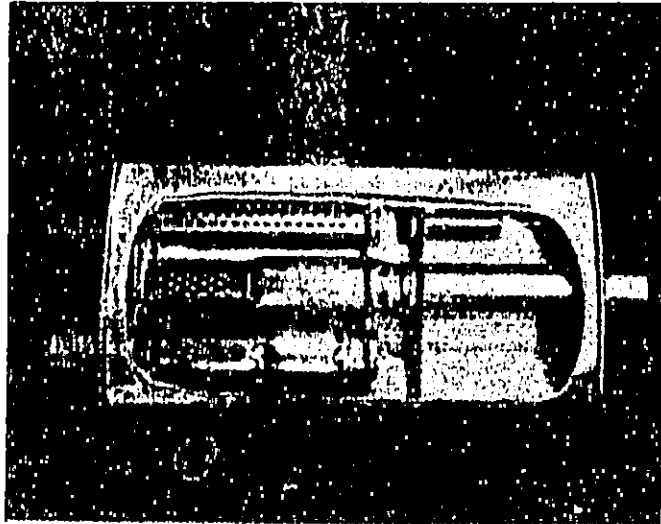

Cut-away View - WACO Muffler
Figure 6
427

BLACK COPY

BEST AVAILABLE COPY

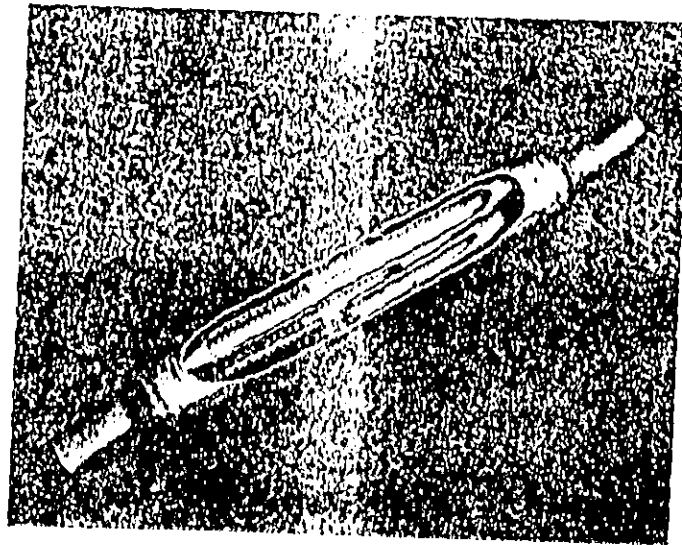

Cut-away View - Unitized Muffler
Figure 7

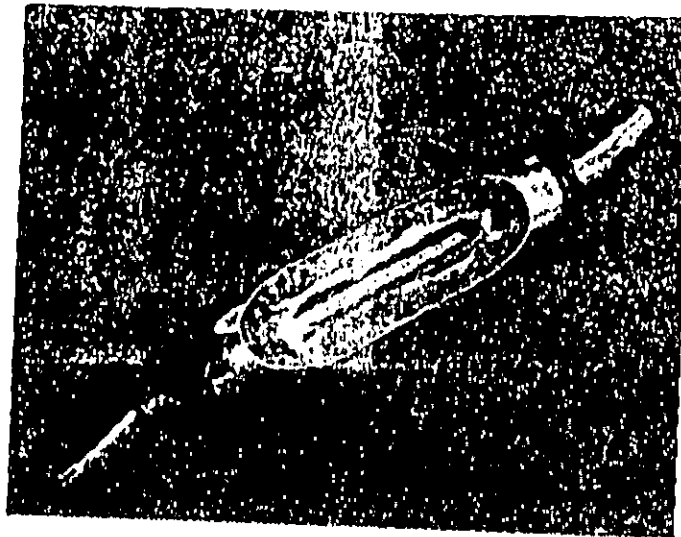

Cutaway View - Glass Pack Muffler
Figure 8
426

BLACK COPY

BEST AVAILABLE COPY

Walker Regular Mufflers

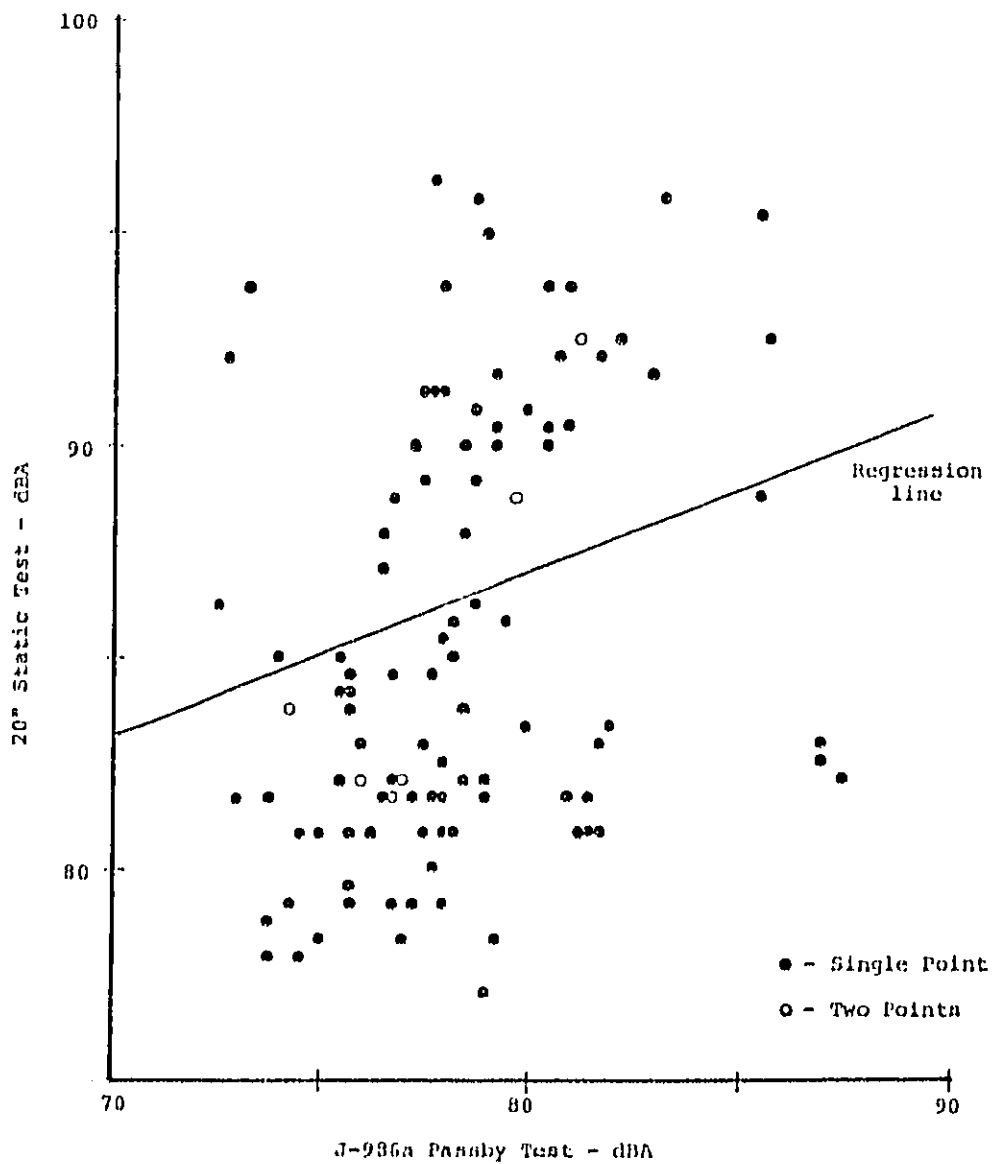

Figure 10

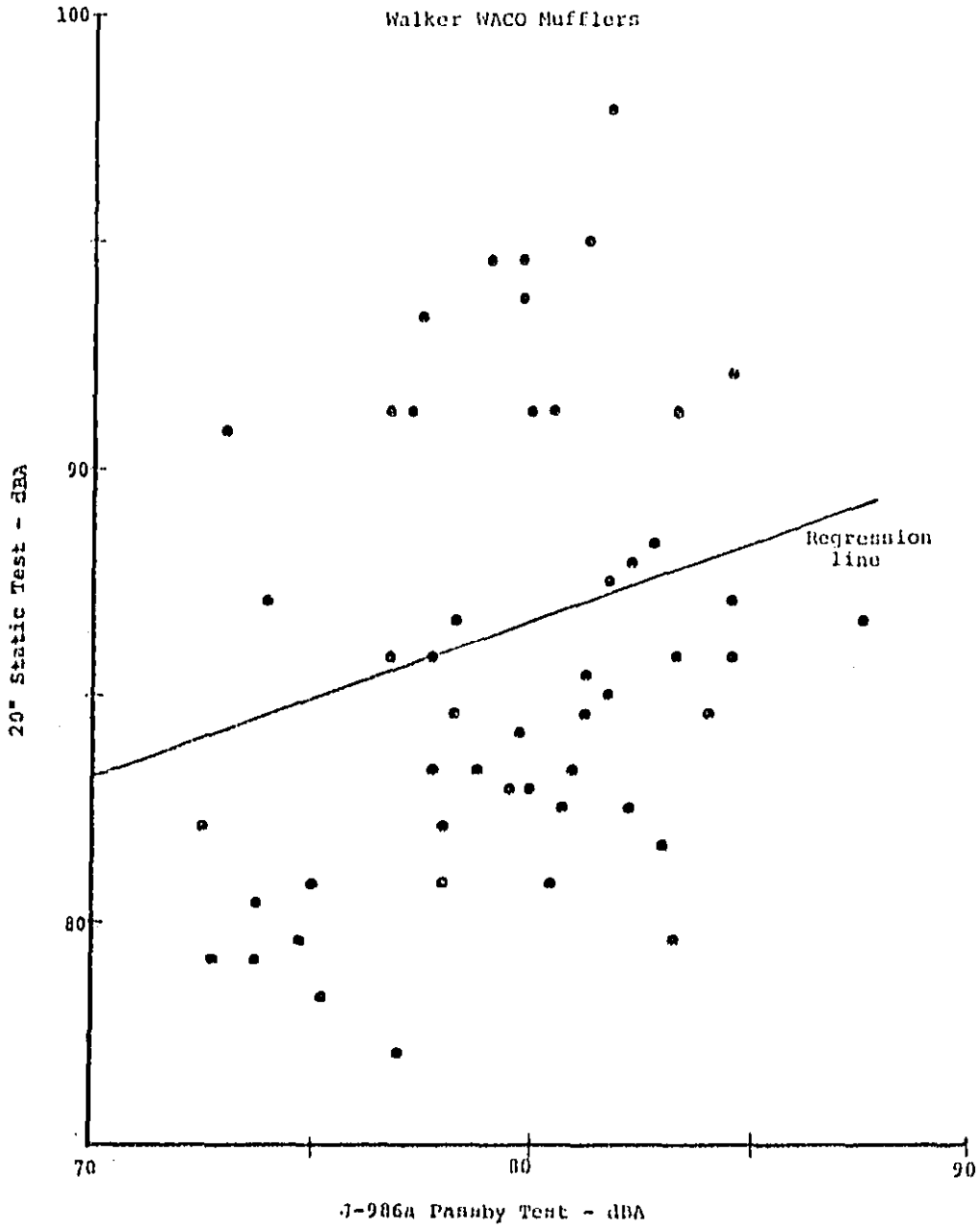

Figure 11

Walker Unitized & Glass Pack Mufflers

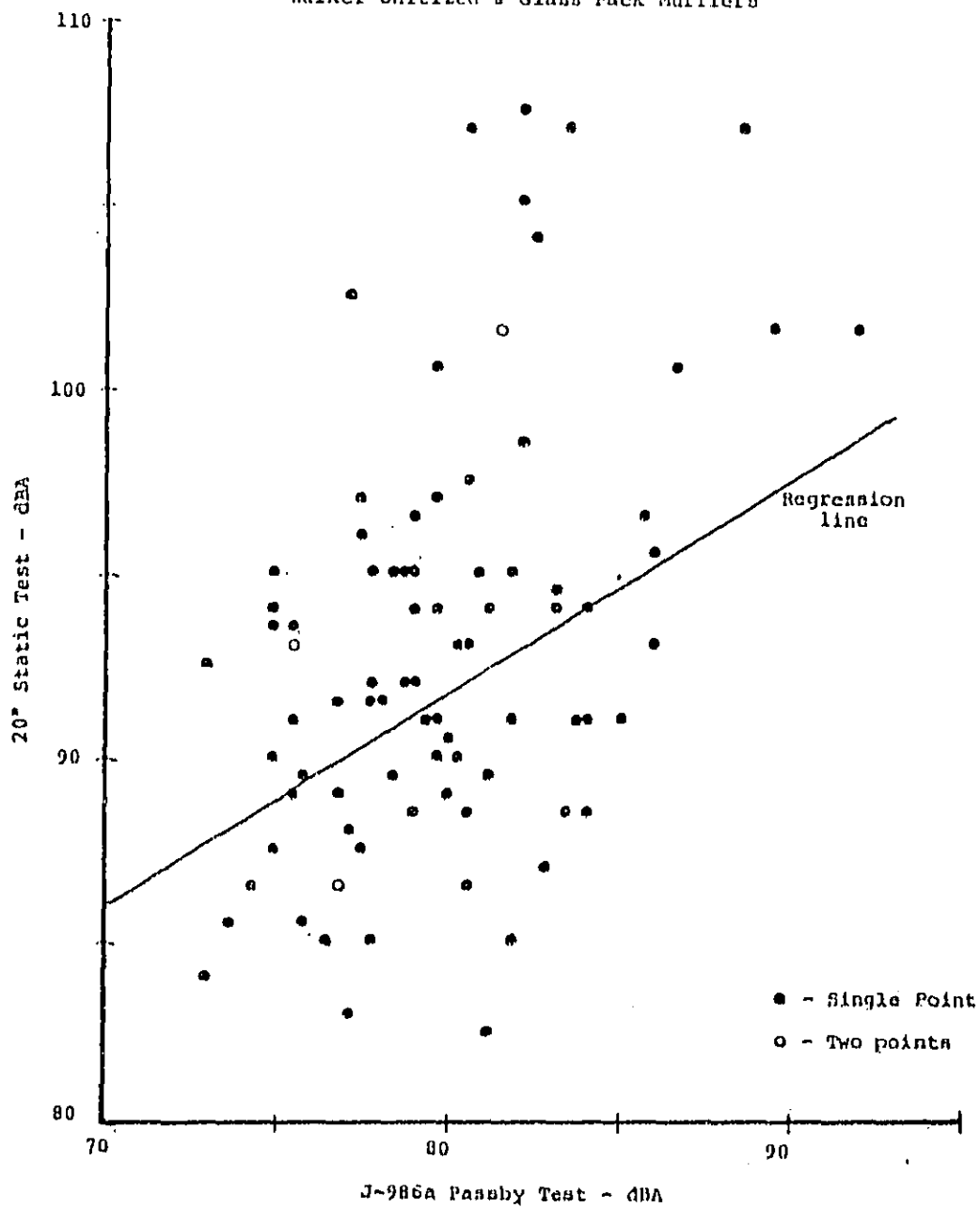

Figure 12

All Mufflers

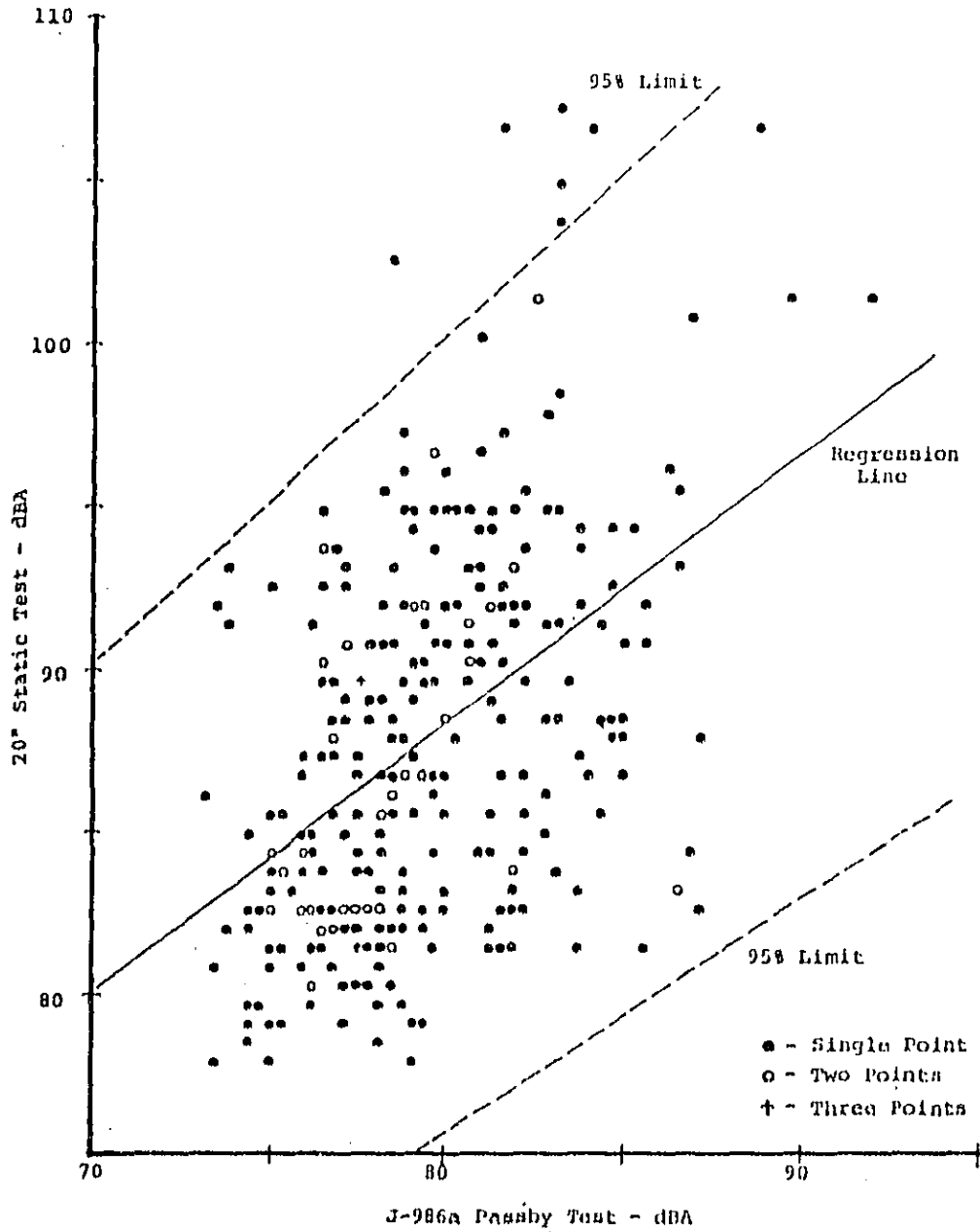

Figure 13
433

DISCUSSION OF PROPOSED SAE RECOMMENDED PRACTICE
XJ1207, MEASUREMENT PROCEDURE FOR DETERMINATION OF
SILENCER EFFECTIVENESS IN REDUCING ENGINE INTAKE OR EXHAUST SOUND LEVEL

by

Larry J. Eriksson
Nelson Industries, Inc.
Stoughton, WI 53589

Presented at the
United States Environmental Protection Agency
Surface Transportation Exhaust Noise Symposium
Chicago, Illinois
October 11-13, 1977

Discussion of Proposed SAE Recommended Practice
XJ1207, Measurement Procedure for Determination of
Silencer Effectiveness in Reducing Engine Intake or Exhaust Sound Level

by
Larry J. Eriksson
Nelson Industries, Inc.
Stoughton, Wisconsin

ABSTRACT

The development of Proposed SAE Recommended Practice XJ1207, Measurement Procedure for Determination of Silencer Effectiveness in Reducing Engine Intake or Exhaust Sound Level is reviewed. This Recommended Practice describes a procedure for a measurement of the actual sound level produced. Successive measurement may be performed to obtain relative performance values or insertion loss. Various considerations in the writing of the procedure are discussed and limitations reviewed.

IN RESPONSE to a need for a standardized test procedure for exhaust and intake silencers, the SAE Vehicle Sound Level Committee (VSLC) formed the Exhaust and Induction Silencer Subcommittee in December of 1974. The objective of this subcommittee was to develop "insertion loss measurement methods in order to provide a rating for the respective devices." Since it was felt that a single procedure was feasible for exhaust and intake silencers, the standard was to be developed in close liaison with the Air Cleaner Test Code Subcommittee of the SAE Engine Committee.

BACKGROUND

Membership was sought for the Exhaust and Induction Silencer Subcommittee (EISSC) from a broad spectrum of technical personnel including those involved with exhaust silencers, intake silencers, engines, and vehicle applications. An organizational meeting was held in March of 1975 to review possible directions for the Subcommittee's work. Numerous existing test procedures were reviewed at this meeting as well as subsequent meetings. These included SAE Recommended Practice J1074, Engine Sound Level Measurement Procedure, and the SAE Recommended Practice J1096, Measurement of Exterior Sound Levels for Heavy Trucks Under Stationary Conditions, as well as procedures developed by such organizations as

the Industrial Silencer Manufacturers Association (ISMA) and Department of Transportation (DOT). Although useful ideas were obtained from many of these sources, no procedure was found to meet the requirements for a standard test procedure for exhaust and intake silencers as specified by the VSLC charge to the Subcommittee.

MAJOR CONSIDERATIONS

Two major areas of concern were discussed in detail. The first was the type of noise source to be used in the evaluation of the silencer. Among those considered were a speaker, a blower, and a standardized engine. Finally, it was concluded that in order to obtain sufficient accuracy, compatible with other SAE Recommended Practices, it would be necessary to use the actual engine and silencer system for which the silencer was to be applied. This approach was thought to have the potential of providing the most accurate engineering data for these types of units.

The second major area discussed was the type of measurement that should be made on the silencers. Again, a broad range of possibilities were considered. These included insertion loss, transmission loss, transfer function, and actual sound level. It was concluded in this case that in order to meet the dual goals of a test procedure that could be widely used as well as provide usable data that could be related to other measurements, the actual sound level produced with the silencer system installed on a given engine should be the measured quantity. It was further noted that the option remained for the test procedure in this form, to be applied successively to different silencers to obtain relative performance values or to silenced and unsilenced cases to obtain insertion loss (IL).

ADDITIONAL CONSIDERATIONS

Other areas discussed included the wide range of sizes of silencers, engines, and test facilities that would be involved in using the desired test procedure. While the subcommittee felt that measurements at 15 metres (50 feet) from the silencer were most desirable to be consistent with other test methods, it was thought that other distances should be allowed in order to make the procedure practical for use with small engines and light duty applications where the available measurement distances are often considerably less than 15 metres (50 feet).

It was also concluded that the procedure should allow for measurements in a free field above a reflecting plane. This may be obtained either in a flat open space or semi-anechoic chamber. The former offers the advantage of a potentially better free-field condition, but also the disadvantage of potentially more problems with ambient noise, wind, temperature gradients, and other weather variables. The latter approach, the semi-anechoic chamber requires extensive wall treatment to obtain adequate free-field behavior, but offers better control over weather conditions and ambient noise. In view of these tradeoffs, the subcommittee decided to include both approaches with specific requirements for both. This decision also resulted in data that were more widely obtainable as well as comparable to those obtained using other test procedures usually performed outdoors.

INITIAL DRAFT

Following these discussions, the first draft of the test procedure was completed in September of 1975. It included the above factors and required an isolated test cell containing the specific engine to be used in the measurement with an adjacent free field above a reflecting plane. The exhaust or intake system was to be piped to this open space and placed in an orientation to the ground as similar as possible to the actual end application. The piping

from the engine to the silencer was to be acoustically treated to eliminate all contributions to the measured level from this pipe. This was done since some pipe had to be excluded in order to connect to the isolated engine and thus, excluding all of this noise was the only practical method to standardize various test facilities that might be used. However, all noise from the surface of the silencer as well as the tailpipe must be included in the measurement along with noise from the acoustical outlet.

This first draft was subsequently extensively modified until finally reaching its final form as approved by the VSLC in June of 1977 and balloted to the SAE Motor Vehicle Council (MVC) in August of 1977.

COMMENTS ON FINAL DRAFT

Among the areas receiving considerable attention during the various revisions was instrumentation. The primary concern was to obtain sufficient information to determine that the engine was functioning properly. The modes of engine operation were also reviewed in detail. It was determined by the subcommittee that the peak sound level could occur under a fairly wide variety of conditions depending upon the specific silencer-engine combination being tested. Thus, a steady state and varying speed mode are required along with an acceleration test for governed engines. Fast dynamic response of the sound level meter was selected for all modes as providing adequate results with minimum potential for error.

The final version of the test procedure does not include any measurement of the restriction of the silencer system. While this is acknowledged to often be an important parameter along with many other specifications, it was not felt to be directly related to the sound level measurement and as such was excluded.

Because of the wide variety of test set-ups this procedure applies to, it is recommended that a photo or diagram of the test set-up be included with the test results.

LIMITATIONS

Among the limitations of this test procedure are the lack of a direct correlation to other overall vehicle pass-by tests as well as the lack of specification of the subjective quality of the exhaust or intake noise. This aspect can be quite important for many applications in which the overall A-weighted sound level is not an adequate description of the acoustic acceptability of a silencer.

APPENDIX A

Members of Subcommittee During Development

<u>Name</u>	<u>Affiliation</u>
*J. Cahill (Secretary)	Stemco Manufacturing Co.
*P. Cheng	Stemco Manufacturing Co.
W. Dreyer	Walker Manufacturing Co.
*J. Dreznes	United Air Cleaner
*F. Egbert	International Harvester Co.
*L. Eriksson (Chairman)	Nelson Industries, Inc.
R. Heath	Walker Manufacturing Co.
R. Hunt	Stemco Manufacturing Co.
S. Koehler	Donaldson Co.
*K. Ligot	Walker Manufacturing Co.
*K. Nowak	Cosmocon, Ltd.
*W. O'Neill	Fram Corporation
*R. Palmer	AP Parts Co.
C. Reinhart	Donaldson Co.
*D. Rowley	Donaldson Co.
G. Shaltz	United Air Cleaner
*D. Thomas	

. . . with contributions from many others

* Current Members

APPENDIX B

MEASUREMENT PROCEDURE FOR DETERMINATION OF SILENCER EFFECTIVENESS IN REDUCING ENGINE INTAKE OR EXHAUST SOUND LEVEL

XJ1207

1.0 Scope - This SAE Recommended Practice sets forth the instrumentation, environment, and test procedures to be used in measuring the silencer system effectiveness in reducing intake or exhaust sound level of internal combustion engines. The system shall include the intake or exhaust silencer, related piping and components. This procedure is intended for engine-dynamometer testing and is not necessarily applicable to vehicle testing (see Appendix A). The effect of the exhaust or intake system on the sound level of the overall machine must be determined using other procedures. This procedure may be successively applied to various silencer configurations to determine relative effectiveness. Insertion loss for individual silencers may be calculated through measurement of the silenced and unsilenced system.

2.0 Instrumentation - The following instrumentation shall be used for the measurement required:

- 2.1 A sound level meter which meets the Type 1 or S1A requirements of American National Standard Specification for Sound Level Meters, S1.4-1971 (R1976).
- 2.2 As an alternative to making direct measurements using a sound level meter, a microphone or sound level meter may be used with a magnetic tape recorder and/or a graphic level recorder or indicating instrument, providing the system meets the requirements of SAE Recommended Practice, Qualifying A Sound Data Acquisition System - J184.
- 2.3 A sound level calibrator having an accuracy within ± 0.5 dB. (See paragraph 6.2.4.)
- 2.4 A windscreen may be used. The windscreen must not affect the microphone response more than $+1$ dB for frequencies of 20 - 4,000 Hz or ± 1.5 dB for frequencies of 4,000 - 10,000 Hz. (See paragraph 6.3.)

- 2.5 If outside tests are being performed, an anemometer or other means for determination of ambient wind speed having an accuracy within $\pm 10\%$ at 19 km/h (12 mph).
- 2.6 A thermometer or other means for determination of ambient and engine intake air temperature, having an accuracy within $\pm 1^{\circ}\text{C}$ ($\pm 2^{\circ}\text{F}$).
- 2.7 A thermometer or other means for determination of fuel temperature at the fuel pump inlet having an accuracy within $\pm 1^{\circ}\text{C}$ ($\pm 2^{\circ}\text{F}$).
- 2.8 A barometer or other means for determination of ambient and engine intake air barometric pressure, having an accuracy within $\pm 0.5\%$ of the actual value.
- 2.9 A psychrometer or other means for determination of ambient and engine intake air relative humidity, having an accuracy within $\pm 5\%$ of the actual value.
- 2.10 An engine dynamometer with engine speed and torque (or power) indicators having an accuracy within $\pm 2\%$ of the rated engine speed and torque (or power).
- 2.11 A flowmeter or other means for determination of engine fuel rate having an accuracy within $\pm 1\%$ of the rated fuel flow.

3.0 Environment - The silencer shall be measured in an environment such that results are equivalent to those obtained in a free field above a reflecting plane. Measurements may be made at a flat open space or in an acoustically equivalent test site as described in Appendix B.

- 3.1 The flat open space or equivalent test site shall be free from the effect of a large reflecting surface, such as a building or hillside located within 30 m (100 ft) of either the silencer opening or microphone. The area directly between the silencer opening and the microphone shall be concrete or sealed asphalt with a total deviation of $\pm 0.05\text{m}$ (± 2 in.) from a plane extending at least 3.0 m (10 ft.) in all directions from all points on the line segment between the silencer outlet and the microphone.
- 3.2 The ambient A-weighted sound level (including wind effects and other noise sources such as the engine) shall be at least 10 dB lower than the level being measured.
- 3.3 Not more than one person other than the observer reading the meter shall be within 15 m (50 ft) of the silencer opening or microphone, and that person shall be directly behind the observer who is reading the meter, on a line through the microphone and the observer, or behind the silencer under test.

4.0 Procedure

- 4.1 The silencer shall be tested on the engine and silencer system for which data will be reported.
- 4.2 The specified silencer system configuration shall provide for measurement of the acoustical radiation from the surface of the silencer or silencers, connecting pipes, and the acoustical outlet of the system. This does not include piping from the engine to the silencer. The silencer system should be oriented in the same relative position to the ground as for the actual application. Any deviation must be reported with the test data. All system connections are to be free from leaks. For determining the insertion loss, the unsilenced system shall include a pipe of physical length equal to the silencer.
- 4.3 The engine and fuel rate shall be measured at full load from 2/3 of rated speed to governed speed, or to rated speed on ungoverned engines, to determine whether the engine is within the engine manufacturer's performance specifications prior to proceeding with this test procedure.
- 4.4 The engine shall be operated in the following modes after reaching normal operating conditions:
 - (a) Steady state mode - rated engine speed and full load.
 - (b) Varying speed full load mode - engine speed to be slowly varied from rated speed to 2/3 of rated speed at wide open throttle.For governed engines only:
 - (c) Acceleration mode - accelerate the engine from idle to governed speed until the engine speed stabilizes and return to idle by rapidly opening and closing the throttle under no load conditions.

5.0 Measurements

- 5.1 The microphone shall be located at a height of 1.2 m (4 ft) above the ground plane and at a horizontal distance of 15 m (50 ft) from the centerline of the silencer system. Other optional distances such as 7.5 m (25 ft) may be used and must be reported. The angular location of the microphone relative to the silencer system opening shall be recorded.
- 5.2 The sound level meter shall be set for fast dynamic response and for the A-weighted network.
- 5.3 For the procedure specified in Paragraphs 4.3 and 4.4, report:

- (a) Engine power and fuel rate as determined in Paragraph 4.3.
- (b) Ambient wind speed, ambient temperature, ambient barometric pressure, ambient relative humidity, and ambient A-weighted sound levels for the test site.
- (c) Maximum A-weighted sound level measured for each test mode in Paragraph 4.4.
- (d) Torque (or power), engine speed, engine intake air temperature, barometric pressure, and relative humidity at which the maximum sound level was obtained.
- (e) Any deviations from recommended test procedure as described in Section 4.2.
- (f) The angular location and distance of the microphone relative to the silencer opening.
- (g) Description of the test configuration, including all pertinent lengths.

6.0 General Comments

- 6.1 It is essential that persons technically trained and experienced in the current techniques of sound measurement select the equipment and conduct the tests.
- 6.2 Proper use of all test instrumentation is essential to obtain valid measurements. Operating manuals or other literature furnished by the instrument and manufacturer should be referred to for both recommended operation of the instrument and precautions to be observed. Specific items to be considered are:
 - 6.2.1 The type of microphone, its directional response characteristics, and its orientation relative to the ground plane and source of noise.
 - 6.2.2 The effects of ambient weather conditions on the performance of all instruments (for example, temperature, humidity, and barometric pressure). Instrumentation can be influenced by low temperature and caution should be exercised.
 - 6.2.3 Proper signal levels, terminating impedances, and cable lengths on multi-instrument measurement systems.
 - 6.2.4 Proper acoustical calibration procedure, to include the influence of extension cables, etc. Field calibration shall be made immediately before and after each test sequence. Internal calibration means is acceptable for field use, provided that external calibration is accomplished immediately before and after field use.

- 6.3 It is recommended that measurements be made only when wind speed is below 19 km/h (12 mph).
- 6.4 It is recommended that a drawing or photograph of the test configuration be included in the reported results.

7.0 References - Documents referenced in this Recommended Practice are:

- 7.1 ANSI S1.4-1971 (R1976), Specification for Sound Level Meters.
- 7.2 SAE J184, Qualifying a Sound Data Acquisition System.
- 7.3 ANSI S1.13-1971 (R1976), Methods for Measurement of Sound Pressure Levels.

ANSI documents available from American National Stds. Inst., 1430 Broadway, New York, NY 10018.

APPENDIX A

A typical test layout may include an engine-dynamometer located in an acoustically isolated test cell adjacent to the test site. The piping from the engine to the silencer should extend from the isolated test cell to the test site. The silencer system should be oriented in the same relative position to the ground as for the actual application. All piping between the engine and silencer should be acoustically treated to meet the requirements of Paragraph 3.2. The sound level measured during the test should include outlet sound as well as shell sound from the silencer and connecting pipes, but not including the piping from the engine to the silencer. The test site may consist of a flat open space or acoustically equivalent indoor or outdoor test site.

APPENDIX B

If a facility other than a flat open space (Paragraph 3.1) is used, the A-weighted sound level from a broad band sound source must not deviate over the test distance from the response in a free field above a reflecting plane more than ± 1 dB. Measurement considerations in American National Standard Methods for Measurement of Sound Pressure Levels, ANSI S1.13 - 1971 (R1976), shall be used.

A Theoretical Examination of the Relevant Parameters
for Dynamometer Testing of 2-Cycle Engine Mufflers

by

Professor G. P. Blair

Department of Mechanical and Industrial Engineering,
The Queen's University of Belfast

Abstract

A powerful design tool has been developed for the prediction of noise and performance characteristics for two-stroke cycle engines of the type used for motorcycles, chainsaws, outboard marine units, or snowmobiles. Here it is used to assess the various parameters involved in dynamometer testing of an engine when fitted with an exhaust muffler by comparison with the normal utilization of the product. A motorcycle example is used to illustrate the several problems inherent in such a technique and the effectiveness of the computer program in providing solutions to them. The precise usage of the computer program is presented in an appendix.

1.1 Introduction

The history of the internal combustion engine is peppered with theoreticians whose dream it is to predict the performance of some particular unit, or type. The history of i.c. engine silencers, or mufflers as they are referred to in the United States, is equally laced with theoreticians with absolute design pretensions. It has always amazed this author that the former group rarely include the detailed geometry of an exhaust (or intake) silencer as part and parcel of their design for engine power or efficiency and that the latter section will cheerfully design a muffler in acoustic, pseudo-acoustic, or in electrically analogous terms as if the engine barely existed. Yet the interrelation of these components is all too obvious.

The blunt truth is that designers of either type have, with some notable exceptions, failed to attempt their theoretical design procedures based on reality, namely the mathematical tracing of the thermodynamic state, position and velocity for every particle of gas from the time it enters the "system" until it leaves it. The "system" is of course the engine and its intake and exhaust silencers. Should such a calculation be carried out then in engine terms its performance characteristics can be deduced as power, torque, fuel and air consumption and thermal efficiency at some particular rotational speed and in noise terms the separated intake and exhaust noise spectra and levels can be determined at any desired location in space from their sources at the "system". That is a design procedure, for then the effect of changing the most detailed of geometry on both noise and performance can be evaluated.

It will be noted in the foregoing that no mention has been made of two-stroke or four-stroke cycle, Diesel or spark-ignition, rotary or reciprocating piston, super/turbo-charged or naturally aspirated engine; nor is there need to for the theories of unsteady gas dynamics are as

catholic in application as the particles of air are non-sectarian on the topic of into which engine type they should be ingested.

2.1 Theory

Computer programs can, and have, been assembled for the derivation of performance characteristics for most of the engine types listed in 1.1, but not many of these solutions have been extended to deriving the intake and exhaust noise spectra created. In the appendix to this paper there is a report issued from the Queen's University of Belfast, report No.1096, describing the input and output data from such a calculation for a single-cylinder, naturally aspirated, spark-ignition, gasoline burning, crankcase compression, two-stroke cycle engine; several species of intake valving can be entered for as can the most complex geometry for the "system" for this common type of i.c. engine. The references in that appendix describe the background experimental and theoretical work over the last thirteen years and the level of correlation between measurement and calculation which now justifies the computational method as a working design tool. Further discussion here would be verbiage.

One of the computer programs, type GPB2, will be used here to illustrate the various problems associated with testing mufflers on a dynamometer as a means of evaluating their performance in their natural environment. As can be seen in the appendix, program GPB2 describes a typical single-cylinder engine with piston controlled inlet porting and having a performance tuned exhaust system but with exhaust silencer consisting of four expansion boxes in series and with a single expansion box type of induction silencer. The actual data used is for an existing 250 cm³ machine sold in the United States for 'enduro' or 'desert' racing. A listing of the 'standard' data is shown in Fig.1 with certain of the values covered, for the data and the engine form part of a design developed

at QUB for a particular manufacturer and are consequently of some confidentiality. Also shown on Fig.1 is the output for the peak horsepower speed of 8000 rev/min and the description of the symbols and the data nomenclature is given in the appendix.

2.2 Theoretical solutions to some problem areas

2.2.1 When a motorcycle engine is being tested on a dynamometer, either without or within its production chassis, and a microphone is placed in the dynamometer test area, unless some acoustic cover is provided for it then it will record the summation of the various noise sources, namely intake, exhaust and mechanical noise. In the nomenclature for program GPB2 the microphone is positioned at distance RPATHI and RPATHE from the intake and exhaust noise sources. The program provides no information as to mechanical noise levels.

The possible experimental solution to the dynamometer assessment of the effectiveness or otherwise of an exhaust muffler would be to acoustically shield the entire test area but have the exhaust orifice appear outside that shield and the positioning of the microphone at RPATHE from that orifice becomes a less critical factor.

A theoretical examination of these possibilities appears in section 3.2.1 by comparison with the noise made jointly by intake and exhaust noise sources under the test conditions imposed by typical acceleration test procedures at 7.5 or 15.0 m employed by several legislative authorities.

2.2.2 One of the simplest methods of silencing any engine device is to throttle the intake or exhaust systems; this has the distinct commercial and ecological disadvantage in that, almost certainly, engine performance and efficiency deteriorate respectively. An examination of the effectiveness or otherwise of this approach is discussed in section 3.2.2.

2.2.3 Under acceleration test conditions on a track the vehicle passes through a torque and power speed range as well as a noise-speed related spectrum. The theoretical program allows one to examine in detail the performance and noise-speed spectrum in detail and permits the redesign of the silencer so as to eliminate the worst noise case at a particular speed point without reducing the overall engine performance; for it is that 'worst' noise point which will register on an acceleration test. Some riders of motorcycles have demonstrated their ability to record lower (by 1 or 2 dB) noise values under acceleration test conditions and this is managed by their instinctive ability to hold that 'worst' noise-speed point to be either well before or well after the minimum microphone to machine distance point. Further discussion of this is contained in section 3.2.1 where actual values are quoted.

2.2.4 One of the difficult assessment problems as to the effectiveness or otherwise of an exhaust muffler, and it applies equally to dynamometer and acceleration track testing, is when an exhaust muffler is being employed in the presence of an intake noise level which is either equal to, or is in excess of, that emanating from the exhaust source. The same comments apply equally to mechanical noise but that is outside the scope of the theoretical examination here. Discussion of this problem with predictions from program GPB2 to assist in its illumination are presented in section 3.2.3.

REST AVAM ASI E COPY

Discussion

- 3.1 The information presented here is but a minor fraction of the total available from the several computer runs involved in numerically highlighting the general nature of potential problems in sections 2.2.1 to 2.2.4.
- 3.2.1 A summary of the main performance characteristics of the engine are shown in Fig.2 over the speed range between 5000 - 8000 rev/min which would be that employed for a typical acceleration test, irrespective of microphone positioning and test conditions. Presented on Fig.2 are both experimental and theoretical values at each speed point for power (bhp), delivery ratio and brake specific fuel consumption (lb/hp.hr). The theoretical values are predicted by the program GPB2 for the listed data in Fig.1 and the experimental or measured values were provided by the engine manufacturer; thus not all theoretical values predicted here have a measured equivalent. The engine is running at full throttle both theoretically and on the measured dyno test data, and as it would be for an acceleration noise test. The theoretical/experimental correlation is quite good.

"Acceleration Test"

The contribution of the intake and exhaust noise sources to the overall noise levels at each speed point on the 'acceleration' test are shown in Fig.3, as predicted theoretically for microphone positions of 15.0 m for both sources. The noise levels on Fig.3 are computed as dBA while the equivalent data for the same situation but with total noise levels calculated are plotted as dBLIN on Fig.4. It can be seen that the intake noise is lower than the exhaust noise in general, but has two quite distinct peaks at 5500 and 7000 rev/min. It will be noted that the peak exhaust noise occurs at 6500 rev/min. The

RSPT AVIATION ASI E 1980

7000 rev/min, irrespective of whether the noise recording occurs by dBA or DBLIN criteria. The overall noise/speed spectrum is quite flat, produced mainly by a noisier and "flat" exhaust noise/speed characteristic. Should the intake noise have been at a higher level a totally different situation would have occurred.

A Test Muffler Problem

The kernel of a potential problem for muffler assessment appears here; let us assume for a moment that the above defined system passed the "test", just. Let us suppose that a new exhaust muffler is to be assessed and it is found that this alternative device has a noise/speed characteristic no higher in peak value than the standard unit, at 75.9 dBA, but the peak occurs at 7000 rev/min and not at the 6500 rev/min for the initial silencer. The nett effect would be that the peak intake and exhaust noise/speed points would coincide and produce a peak noise at 6500 rev/min perhaps 2dB higher than the current highest value. Does this silencer then fail the "acceleration" test; almost certainly for the peaks tend to get recorded!

Typical Noise Spectra

The program predicts the intake, exhaust and overall noise spectra at whatever independent microphone position is selected. Present in Fig.5 is the noise spectra from the 7000 rev/min positions in the calculations discussed above. It can be seen that the principal source of noise is the peak in the exhaust noise spectrum between 450 and 700 Hz, whereas the intake noise spectrum has a dip at that position, otherwise the overall noise peak would have been even higher. It can be seen that the exhaust noise spectrum falls off rapidly after 1000 Hz whereas the intake spectrum stays very flat until 2000 Hz. The combination of these two characteristics results in a sustained noise source with a relatively flat overall residual spectrum, influences the overall sound level and should be the frequency to be tackled by (say) a suitable side resonator element in any redesign of the unit.

Microphone Positioning

In a dynamometer test situation where the intake (and mechanical) noise is not shielded from the microphone which is being used to record (or attempt to record) the exhaust noise then the microphone positioning becomes critical. The relatively obvious conclusion is to place it as close to the exhaust noise outlet as is practical. An attempt to illustrate this point is made in Figs. 6 and 7 in the form of tabular data and in Fig.8 as a graphical representation.

In Fig.6 is shown the intake, exhaust and overall sound pressure levels (dBA) for several combinations of microphone positioning relative to the intake source point (RPATHI) and the exhaust outlet (RPATHE), with the relative positioning being mostly 0.5 m nearer to the inlet in most cases for dyno work and 7.5/7.5 or 15.0/15.0 m to represent the acceleration equivalent. The reverse situation is shown in Fig.6 where the microphone is more logically placed closer to the exhaust outlet.

At equal/equal microphone positioning it will be remembered that the exhaust noise is some 2dB greater overall than the intake level. A close examination of the figures reveals the relatively obvious, namely, the closer one approaches the exhaust outlet with the microphone the more nearly does the exhaust noise level and the overall noise level coincide. Thus any careless positioning of the microphone, such as positioning (b) or (c) in Fig.6, would mitigate against any clear assessment of a 1 or 2dB difference in the performance of any particular exhaust muffler. The curves of noise levels for intake and exhaust noise at various independent microphone positions are shown together on Fig.8. While equal/equal microphone positioning produces an approximately constant 2dB differential, the differential microphone positioning for equal noise levels from both sources increases with

distance. In other words at 100dB noise level from both sources the differential microphone positioning is 0.2 m at about 0.75 m median value but for 76dB equality the differential spacing is 3.2 m on a 12.3 m median point.

Close positioning of the microphone to the exhaust outlet would not necessarily require the acoustic shielding of other noise sources for dynamometer test purposes.

3.2.2 Throttling the Exhaust Outlet

The four-box silencer used in the relatively simple silencer design discussed in the previous sections has basically four elements of different volumes connected by 24 mm diameter tubes. The calculation at 7000 rev/min was repeated for a microphone positioning of 7.5/7.5 m equality of distance from intake and exhaust inlet/outlets respectively. It will be remembered that 7000 rev/min was the highest noise point on the noise/speed characteristic. In each of five calculations the diameters DD1, DD1R, DD2 and DD2R were changed successively from 16.0 to 18.0 to 20.0 to 22.0 and to 24.0 mm; the latter value being the original standard calculation. In other words the final outlet tube diameter was changed from 16.0 mm to the standard 24.0 mm value in several steps. The results for power, delivery ratio, brake specific fuel consumption and exhaust, intake and overall noise are shown on Fig.9.

There is no doubt that throttling the exhaust outlet down to 16.0 mm from 24.0 mm diameter certainly reduces the overall noise by some 4dB, but more significantly to below the levels for the intake noise which now becomes the predominant source. The equality of noise level occurs at an outlet diameter of 22 mm; here the overall noise level is reduced by just 1.5 dB for 0.5 hp penalty in power and none in fuel consumption. Significantly, although the air flow was reduced by some 2% the intake noise slightly increased.

Further throttling to 16.0 mm produces a considerable drop in power (6 hp), a deterioration in engine efficiency (the bafc increased by some 10%); while the air flow rate decreased by some 15% the intake noise barely altered, indeed it actually increased by 1dB at the point where the outlet diameter was 20 mm.

It can be seen that in any muffler assessment program, a device which is overly restrictive on the entire system reduces both engine power and efficiency, and must be recognised and categorized as such a device. The test methods should be capable of differentiating between the silencer which is allowing the engine to produce its rated power and efficiency within the noise limits and the badly designed or produced device which derates the power unit so as to fit within the legislative framework. In these ecologically-conscious days retention of high engine thermal efficiency is as important as excessive noise.

3.2.3 In section 3.2.1 the importance of the design of the intake silencer was pointed out; particularly emphasized was the necessity to ensure that the noise peak in the intake spectrum did not coincide with that from the exhaust system.

On the "standard" engine the intake box, Box 1, had a volume of 7200 cm³ with a 40 mm outlet tube diameter (all diameters DS1 - DS2R). This was replaced by a smaller box, Box 2, of 2500 cm³ volume and a tube of 44 mm diameter of the same length. This was so arranged as to produce the same total air flow at 7000 rev/min and therefore the same power from the engine with a common "standard" exhaust system for each "paper-engine computer-dynamometer test" situation. The exhaust noise is unaltered in consequence.

The overall noise (intake) levels and their frequency spectrum are shown in Fig.10 and the first point to be observed is greatly increased overall sound pressure level peak (dBLIN) at the first

harmonic (116.7 Hz). It is at this point that one must observe that one has grave doubts about the legitimacy of the A-weighting factor at this frequency; for be assured that should one ride a motorcycle with such a replacement (Box 2) intake silencer box than this low frequency noise peak would be obtrusive and unpleasant. As the facts stand the application of the A-weighting characteristic produces an overall sound level for Box 2 only 0.6dB higher than the original design. Perhaps it is time to reconsider the application of a total sound pressure level (dB(LIN)) criteria for legislative purposes.

Conclusions

The theoretical procedures illustrated here show the usefulness of a design tool which is that in a true sense; it has the capability to reveal the separate intake and exhaust noise production at independent distance assessment points as well as the interaction of the intake and exhaust mufflers on the engine and its performance parameters.

The program here is oriented towards the two-cycle motorcycle, outboard, snowmobile, chainsaw, or industrial engine type; there is no theoretical barrier to its application to any internal combustion engine which inhales or exhales in the commonly unsteady manner.

Acknowledgements

The author would like to acknowledge the efforts of past research students at The Queen's University of Belfast who laid the groundbase for this computer program series and who carried out the experimental work to verify the accuracy of their theoretical premises; Dr. J. A. Spechko (at Warner Electric), Dr. S. W. Coates (at Mercury Marine) on the noise programs; Dr. W. L. Cahoon (at Mercury Marine) and Dr. H. C. Ashe (at Kohler) on the engine gas flow studies.

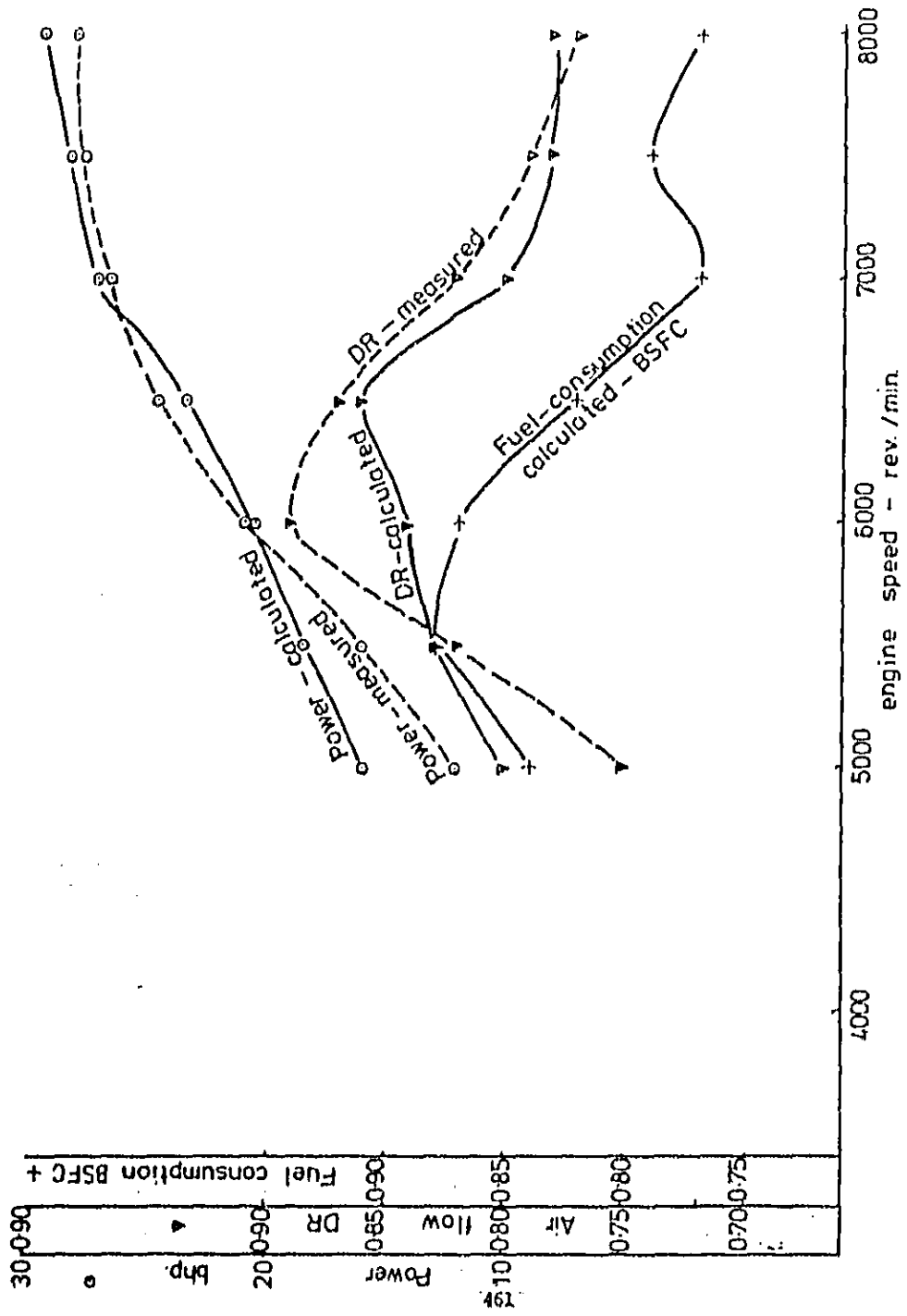

Fig. 2

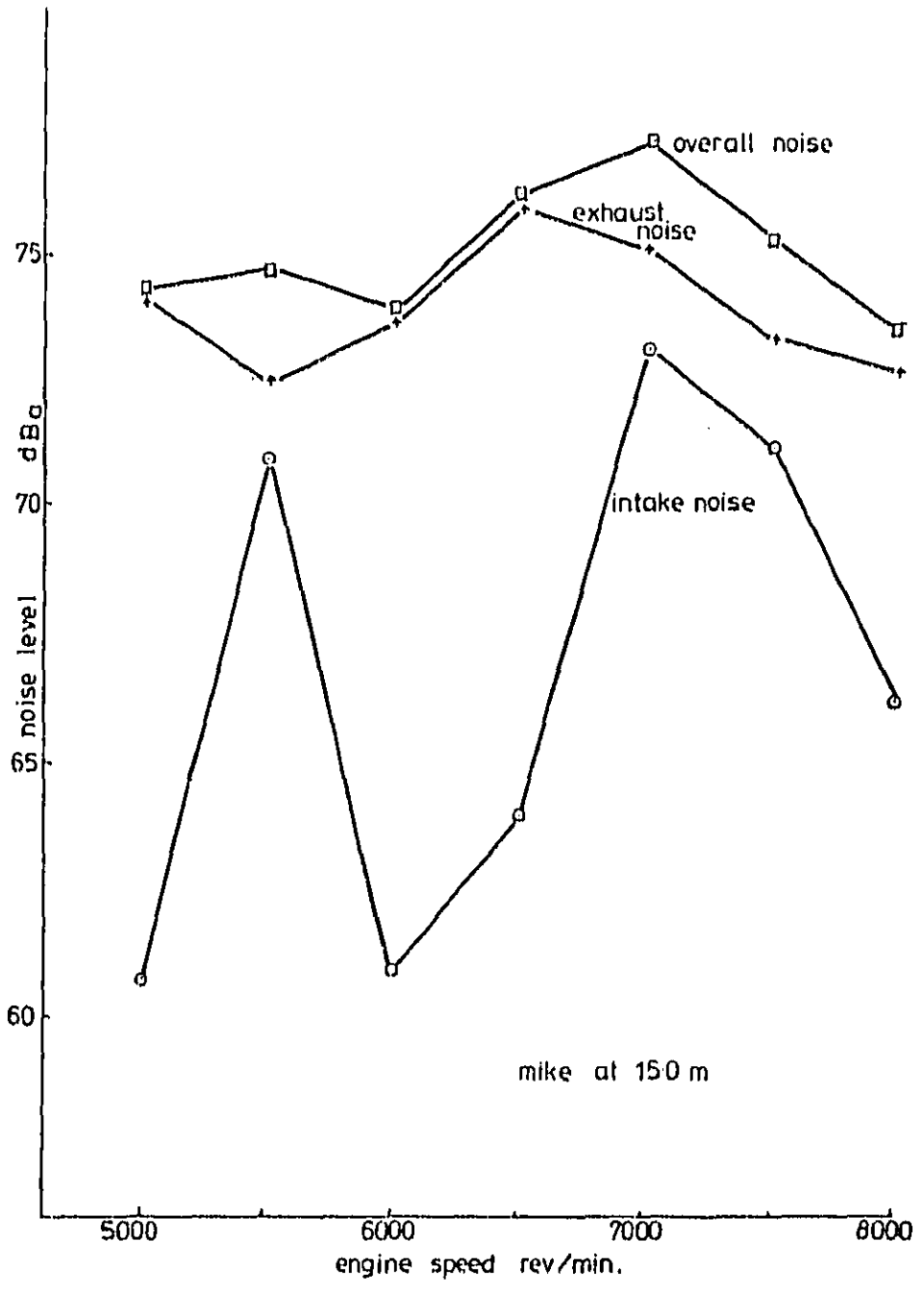

Fig. 3.

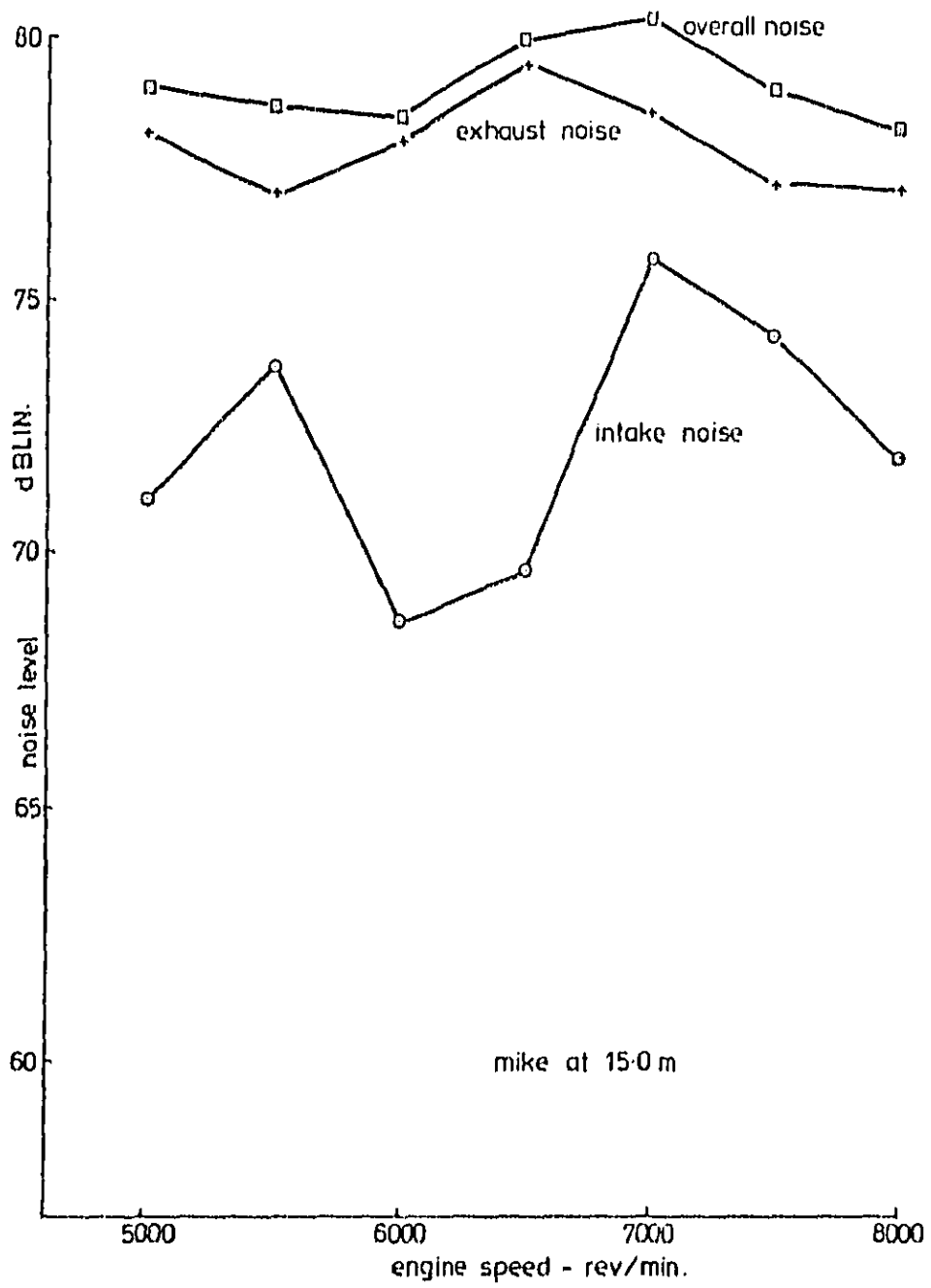

Fig. 4.

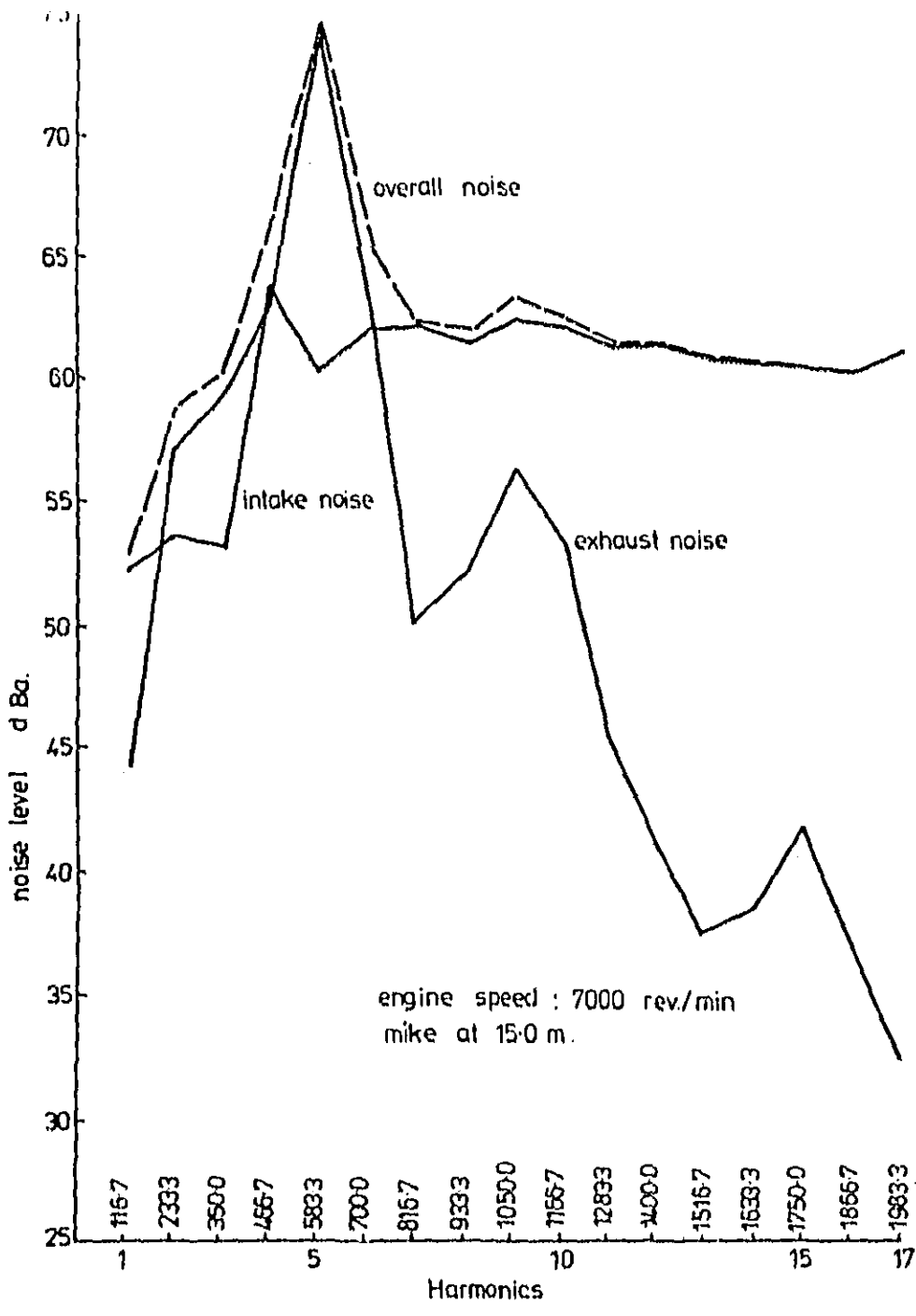

Fig. 5.

MICROPHONE POSITIONS

	<u>RPATHI</u>	<u>RPATH E</u>	<u>INTAKE dBA</u>	<u>EXHAUST dBA</u>	<u>OVERALL NOISE dBA</u>
(a)	0.25	0.75	108.6	101.1	109.3
(b)	0.5	1.0	102.6	98.6	104.1
(c)	1.0	1.5	96.6	95.1	98.9
(d)	2.0	2.5	90.6	90.6	93.6
(e)	7.5	7.5	79.1	81.1	83.2
(f)	15.0	15.0	73.1	75.1	77.2

FIG. 6 - MICROPHONE PLACED NEARER TO INTAKE SOURCE

MICROPHONE POSITIONS

	<u>RPATHI</u>	<u>RPATH E</u>	<u>INTAKE dBA</u>	<u>EXHAUST dBA</u>	<u>OVERALL NOISE dBA</u>
(a)	0.75	0.25	99.1	110.6	110.9
(b)	1.0	0.5	96.6	104.6	105.3
(c)	1.5	1.0	93.1	98.6	99.7
(d)	2.5	2.0	88.6	92.6	94.1
(e)	7.5	7.5	79.1	81.1	83.2
(f)	15.0	15.0	73.1	75.1	77.2

FIG. 7 - MICROPHONE PLACED NEARER TO EXHAUST SOURCE

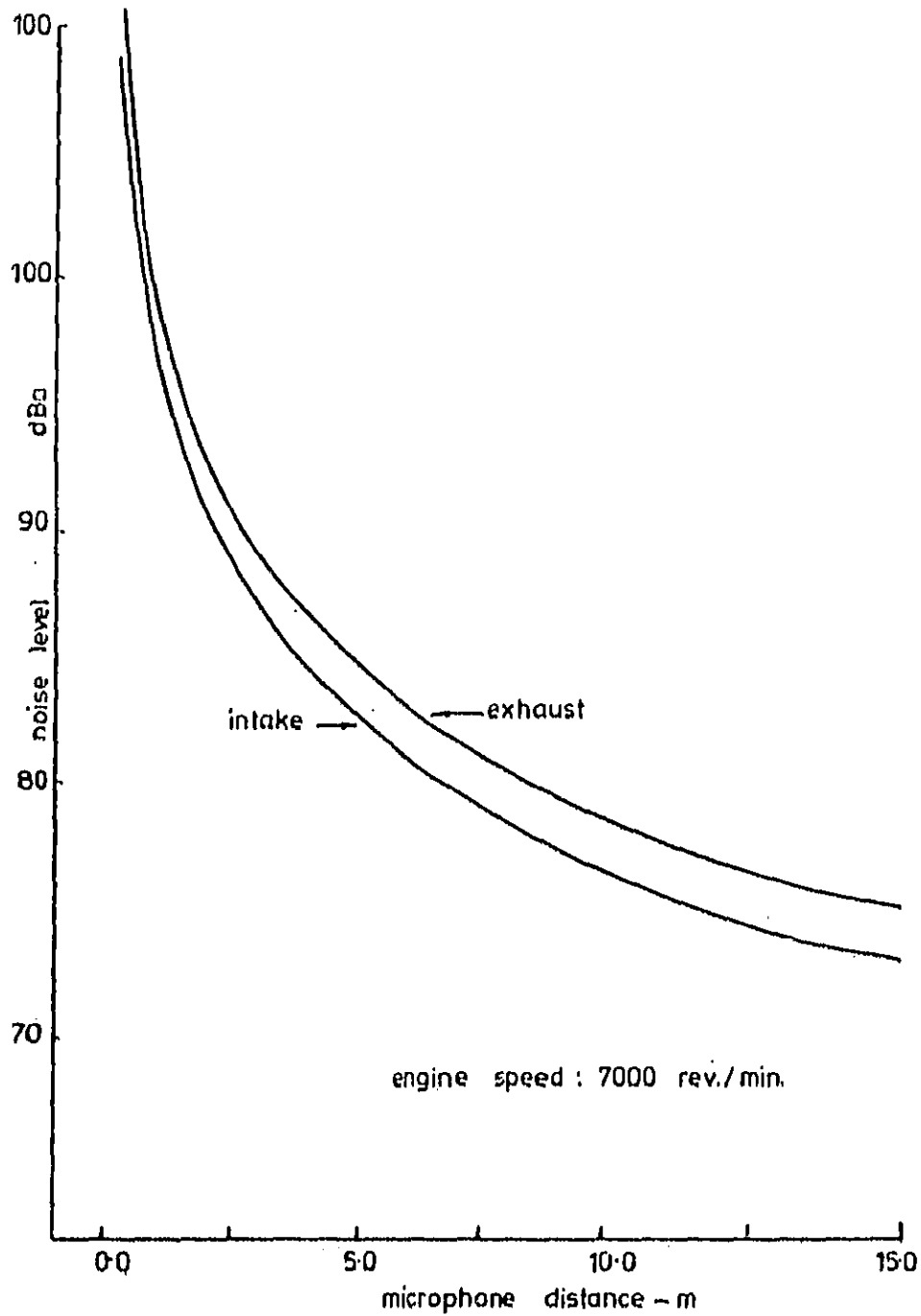

Fig. 8.

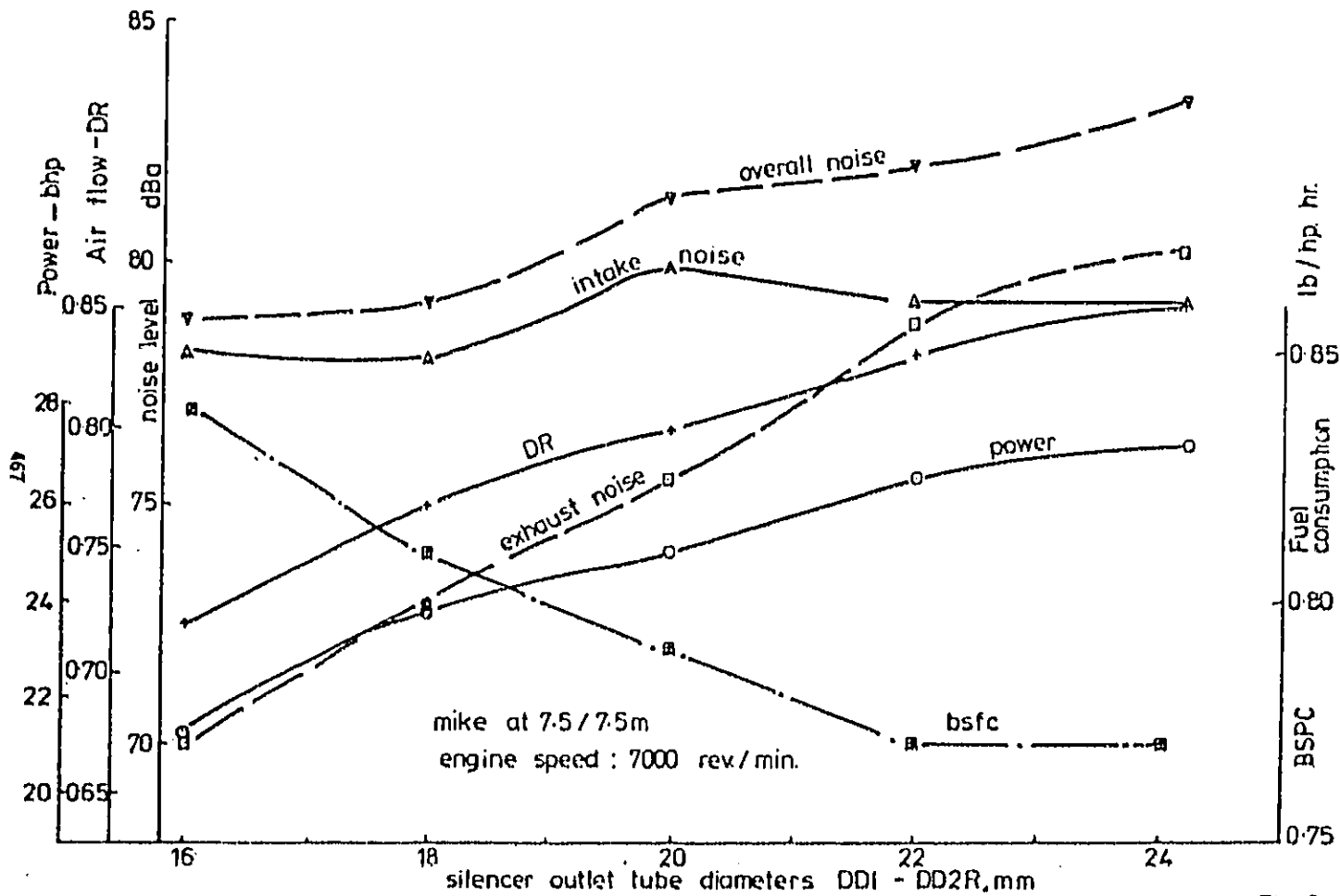
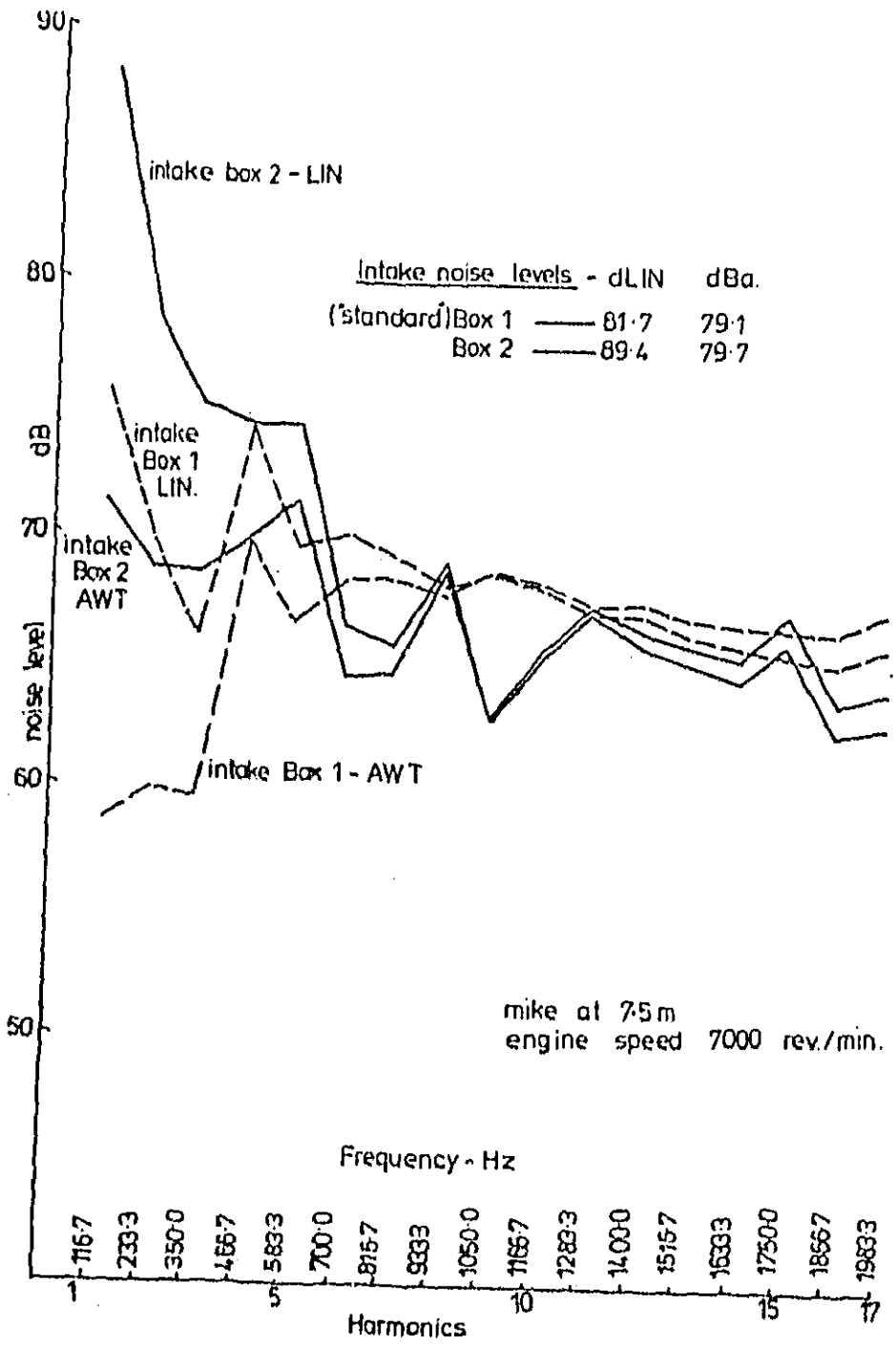

Fig. 9.



REPRODUCED FROM THE ORIGINAL DOCUMENT

A P P E N D I X

Report No.1096 of The Queen's University of Belfast
on a Computer Program for the Prediction of Noise and
Performance Characteristics of a Two-Cycle Engine

by

Professor G. P. Blair

A Computer Program for the
Prediction of Noise and Performance
Characteristics of a Two-Cycle Engine

by

Professor G. P. Blair

Report No.1096

Summary

This report contains a description of the data sheets for the use of a computer program called "THROUGHFLOW" which predicts the performance characteristics of power, torque, fuel consumption, air flow, etc., as well as the separate intake and exhaust noise spectra and their overall separate and combined noise levels. A brief description of the input and output data is included, as is reference material for further study and as background material and as experimental proof of the accuracy of the prediction method.

Ashby Institute, Stranmillis Road, Belfast BT9 5AH Telephone ~~48433~~ 74487
661111

'THROUGHFLOW' - a computer program to predict the performance and noise characteristics of a crankcase compression two-stroke cycle engine

Research work at The Queen's University of Belfast over the period 1964 to the present day has been aimed at understanding the unsteady gas flow behaviour of all types of engines, two and four-stroke cycle, Diesel or spark ignition, supercharged or naturally aspirated, with reciprocating or rotary piston mechanisms.

Recent work published by Blair and Cahoon (1), Blair and Ashe (2) and Blair (3) shows how this research work has moved with a natural progression from prediction of gas flow through the engine to direct evaluation of the engine's performance characteristics of power, torque and specific fuel consumption. Related work by Blair and Coates (4) and (5) described the method of evaluating gas-borne noise created by pulsating pipe systems and this has now been incorporated with the above-mentioned prediction computer program to give noise characteristics for the intake and exhaust systems or their combined effect.

The data sheets which follow this section detail the geometrical details of the naturally aspirated, gasoline burning, crankcase compression, spark ignition two-stroke cycle engines which can be analysed with this program. There are several variations of intake and exhaust systems which can be handled, and for the several types of induction system such as piston, reed and disc valve control.

The main types of engine handled are

- (a) exhaust tuned units (motorcycles and snowmobiles)
- (b) non-exhaust tuned engines (industrial, chainsaws, lawnmowers)
- (c) the 'in-between' units or part exhaust tuned (outboards)

The signature of the programs applying mainly to units typified in

(a) are:-

GPB2 and GPB6

The signature of the programs applying mainly to units typified in (b) and (c) are:-

GPB1, GPB3 and GPB5

The middle initial P refers to the program indexing a "piston-ported" induction process, with the data oriented in sequence to suit that program. Middle initials R and D refer to "reed-valve" and "disc-valve" induction characteristics. In other words program GPB1 refers to a piston-ported industrial engine with a single exhaust and a single intake box silencer (see data sheet later) and programs GRB1 and DRB1 would calculate the alternate noise and performance characteristics for the same systems but for 'reed' and 'disc' valved units.

The numeric symbol 1 - 6 defines the type of exhaust system attached to the engine, all units having a single "box and tube" intake silencer. To illustrate this, apart from examining the sketches in the data sheets which follow -

Program GPB1 has a single box/tube exhaust silencer, without a tuned exhaust system.

Program GPB2 has a set of four box/tube exhaust silencers, with a tuned system.

Program GPB3 has two box/tube silencers, without a tuned exhaust system.

Program GPB5 has two box/tube silencers with one tube perforated, and without a tuned exhaust system.

Program GPB6 has a single perforated tube silencer and a tuned exhaust pipe system.

The following page, Fig.A, is a reproduction of an actual computer output for program GPB1 - a piston-ported induction unit, actually of the chainsaw type.

The first half of the 'output' from the program is the "input" data as specified in the data sheets which follow and in the exact order of the data listed in that section. In other words from BORE to ATOF (cylinder bore, rpm to air to fuel ratio) is the data listing for the engine. The units are metric

(SI) and linear dimensions are mm, with exhaust temperature (T_{WAL}) listed as °C.

The second half of the output is the result of the calculations for the first six cycles of the engine running on the computer as a 'paper engine', with the fifth and sixth cycle calculations printed out for power BHP, brake specific fuel consumption BSFC, etc., at the input value of engine speed, RPM. The noise calculations, spectrum or overall values are for the last (sixth) cycle only.

The pressure-crankshaft angle pictures are also drawn by the computer graph plotter for the last (sixth) cycle calculation, see Fig.B, and an explanation of the relevance of the particular graphs is written on that figure.

The output contains symbols defined below:

RPM: engine speed rev/min (also an input data value)

POWER: engine power as
BHP - based on brake horsepower (746W)
or KW - kilowatts, kW

BSFC: brake specific fuel consumption as
LB - lb/hp hr
or KG - kg/kW h

BMEP: brake mean effective pressure as
PSI - lb/in²
or KPA - kPa

IMEP: indicated mean effective pressure as
PSI - lb/in²
or KPA - kPa

PUMPMEP: crankcase pumping mean effective pressure as
PSI - lb/in²
or KPA - kPa

FMEP: friction mean effective pressure as
 PSI - lb/in²
 or KPA - kPa

DR: delivery ratio defined as

$$\frac{\text{mass air flow induced per cycle}}{\text{mass of engine's swept volume at STP}}$$
 where STP is "standard temperature (20°C) and pressure
 (760 mm Hg or 101.326 kPa)"

CE: charging efficiency defined as

$$\frac{\text{mass of air trapped per cycle}}{\text{mass of engine's swept volume at STP}}$$

TE: trapping efficiency defined as

$$\frac{\text{mass of air trapped per cycle}}{\text{mass of air induced per cycle}}$$

SE: scavenging efficiency defined as

$$\frac{\text{mass of air trapped per cycle}}{\text{total mass trapped per cycle}}$$
 (also can be seen as 'trapped charge purity')

PTRAP: trapping pressure, or pressure at exhaust port closure in
 units of atm.

PREL: release pressure, or pressure at exhaust port opening in
 units of atm.

PMAX: maximum cylinder pressure during combustion in units of atm.

TWAL: also an input value, exhaust temperature, °C.

SCAV: SCAVDEG, the number of degrees of 'perfect' scavenging after
 transfer port opening. For a fuller explanation see reference (2).

The next section of output deals with the noise output analysed over
 the last (sixth) cycle of calculation. The first part shows the noise spectrum
 for the first to the nth harmonic up to a maximum of frequency of 2000 Hz
 applied to the intake system and the exhaust system at their respective
 distance (RPATHI and RPATHE) from the 'microphone'. Also shown is the total
 or overall noise spectra, the combined noise spectra of the intake and exhaust

R50T AVIAN ASE R 000V

system. The values are in dB and are analysed as LIN (overall sound pressure level in dB) or as AWT (weighted according to the A-weighting scale factors in dBA).

The last line of the output shows the summation of all of these spectra to give the total intake noise (LIN and AWT), the total exhaust noise (LIN and AWT), and the combined noise for both noise sources (LIN and AWT).

The graphical output in Fig.8 shows the pressure-time histories in two sets, for reasons of clarity.

Set I: at the top of the picture are the crankcase and inlet port pressures (in atm.) with the horizontal line being atmospheric pressure (1.0 atm.).

Set II: at the bottom of the picture are the cylinder, exhaust port and the (middle of) transfer duct pressures (in atm.) with the horizontal line being atmospheric pressure (1.0 atm.).

The x-axis of the pictures run from TDC to TDC (on the sixth cycle) or 360° crankshaft where BDC at 180° is the centre of the picture. TDC and BDC refer to top-dead-centre and bottom-dead-centre piston positions respectively. The vertical lines drawn on the diagram; apart from TDC, BDC and TDC are IO and IC (inlet port opening and closing), TO and TC (transfer port opening and closing), and EO and EC (exhaust port opening and closing).

REFERENCES

1. G. P. Blair and W. L. Cahoon, "A More Complete Analysis of Unsteady Gas Flow Through a High-Specific-Output Two-Cycle Engine", SAE Transactions Vol.81, 1972, SAE 720156.
2. G. P. Blair and M. C. Ashe, "The Unsteady Gas Exchange Characteristics of a Two-Cycle Engine", SAE Off-Highway Vehicle Meeting, Milwaukee, Sept. 1976, SAE 760644.
3. G. P. Blair, "Prediction of Two-Cycle Engine Performance Characteristics", SAE Off-Highway Vehicle Meeting, Milwaukee, Sept. 1976, SAE 760645
4. G. P. Blair and S. W. Coates, "Noise Produced by Unsteady Exhaust Efflux from an Internal Combustion Engine", SAE Transactions Vol.82, 1973, SAE 730160.
5. S. W. Coates and G. P. Blair, "Further Studies of Noise Characteristics of Internal Combustion Engine Exhaust Systems", SAE FCIM Meeting, Milwaukee, Sept. 1974, SAE 740713.

Data Sheet for "Throughflow" - a complete scavenging,
induction and exhaust analysis of a crankcase
compression two-stroke cycle engine.

Professor G. P. Blair

ENGINE NAME _____

ENGINE TYPE _____

NO. OF CYLINDERS _____

INDUCTION SYSTEM: (a) Piston ported _____

(b) Disc Valve _____

(c) Reed Valve _____

Dimension	Symbol	Units	Data Value
1. Cylinder Bore, diameter	BORE	mm	_____
2. Cylinder Stroke, length	STROKE	mm	_____
3. Connecting rod centres, length	CRL	mm	_____
4. Crankshaft speed	RPM	Rev/min	_____
5. Exhaust port timing, at opening, degrees ATDC	EXHSOPEN	degrees	_____
6. Transfer port timing at opening, degrees ATDC	TRANSOPEN	degrees	_____
7. Inlet port opening, degrees BTDC	ENOPEN	degrees	_____
8. Cylinder trapped compression ratio	TRAPCR		_____
9. Crankcase geometric compression ratio, including transfer duct volume	CRANKCR		_____
<u>OR</u> Crankcase clearance volume including volume of all transfer ducts	CRANKVOL	cm ³	_____

TABLE I

See Figs.1 and 2, for further details

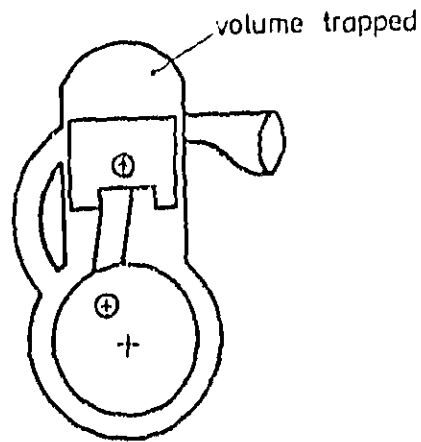

Fig.1 Crankshaft position shown at exhaust closing position, the trapping position, usually EXHOPEN deg BTDC.

$$\text{TRAPCR} = \frac{\text{VOLUME TRAPPED}}{\text{CLEARANCE VOLUME of COMBUSTION CHAMBER WITH PISTON at TDC}}$$

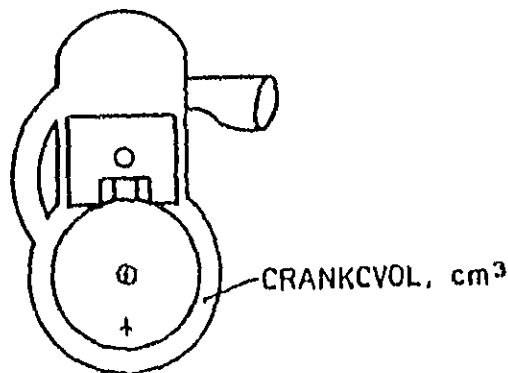

Fig.2 Crankshaft position shown at bottom dead centre, B.D.C. - note all transfer ducts are open, and the volume under the piston is then the crankcase clearance volume, measured in cm^3 . If SV is the swept volume per cylinder, cm^3 then -

$$\text{CRANKCR} = \frac{\text{SV} + \text{CRANKCVOL}}{\text{CRANKCVOL}}$$

TABLE 2

Dimension	Symbol	Units	Data Values
10. number of exhaust ports	EXPNO		---
11. maximum effective width of each exhaust port	EXHSPRTWID	mm	--- --
12. corner radius on top edge of each exhaust port	EXTRAD	mm	--- --
13. corner radius on bottom edge of each exhaust port	EXBRAD	mm	--- --
14. maximum height of exhaust port i.e. not extended to piston BDC position	EXHSPRTHMAX	mm	--- --

Note: A data value for EXHSPRTHMAX of 0.0 in the program indicates that the exhaust port height extends to BDC.

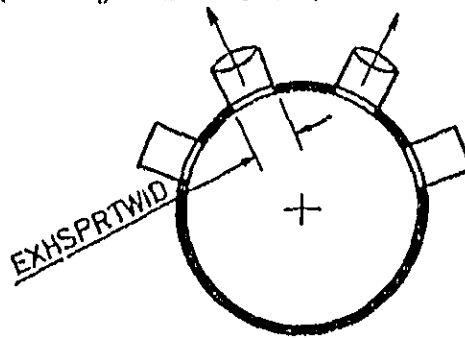

Fig.3 Plan section on exhaust ports

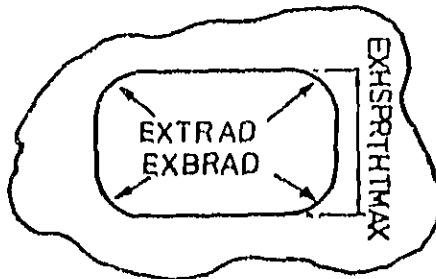

Fig.4 Elevation on an exhaust port

TABLE 2

Dimension	Symbol	Units	Data Values
15. Number of transfer ports	TRANSPNO		_____
16. Total effective transfer port width (usually $2(a + b + c)$)	TRANSPWID	mm	_____
OR WIDTH (a)	a	mm	_____
WIDTH (b)	b	mm	_____
WIDTH (c)	c	mm	_____
16a. Port elevation angles	θ_A	degrees	_____
	θ_B	degrees	_____
	θ_C	degrees	_____
17. Corner radius on upper edge of transfer port	TRTRAD	mm	_____
18. Corner radius on lower edge of transfer port	TRBRAD	mm	_____

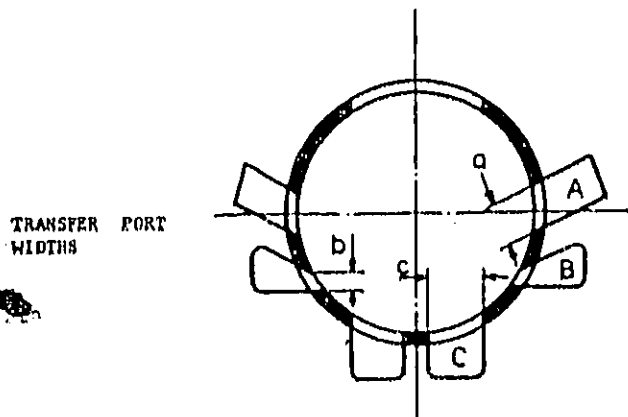
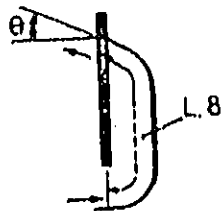

Fig.6 Plan Section through transfer ports

PORT ELEVATION ANGLES



- θ_A , port type A _____ deg
- θ_B , port type B _____ deg
- θ_C , port type C _____ deg

Fig.6 section, elevation, through port A, B, or C.

BEST AVAILABLE COPY

TABLE 4

Dimension	Symbol	Units	Data Values
19. number of inlet ports	ENPRO		_____
20. maximum effective width of each inlet port	ENPRTWID	mm	_____
21. corner radius on top edge of each inlet port	ENTRAD	mm	_____
22. corner radius on bottom edge of end inlet port	ENBRAD	mm	_____
23. maximum possible inlet port height	ENPRTHMAX	mm	_____
24. carburettor flow diameter	DIP	mm	_____
25. inlet port down draught angle wrt cylinder centre-line	DOWNDRAFT	degrees	_____
26. length from piston face to the position where tract area equals carburettor flow area	L6	mm	_____
27. length inlet tract where trace area essentially equals carburettor flow area	L7	mm	_____

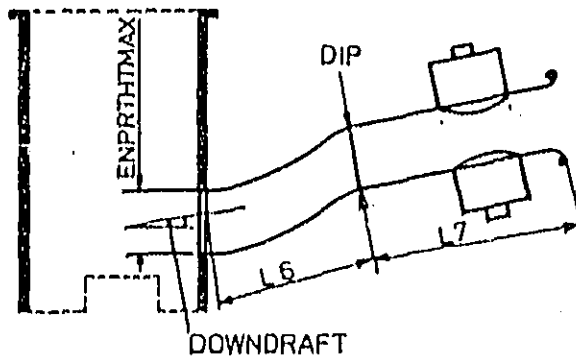

Fig.7 Section through inlet tract for piston-port induction system.

FOR PROGRAMS GD ____, INDICATING THAT THE PROGRAM REFERS TO A TWO-STROKE DISC VALVE (D) ENGINE.

Disc valve, or Rotary Valve Induction

data values indicating the following: ENPRTHMAX, ENTRAD, ENBRAD, ENPRTWID on R MEAN should be entered on Table 4 as the equivalent named data values numbered 23, 21, 22, 20 and also data number 28 below.

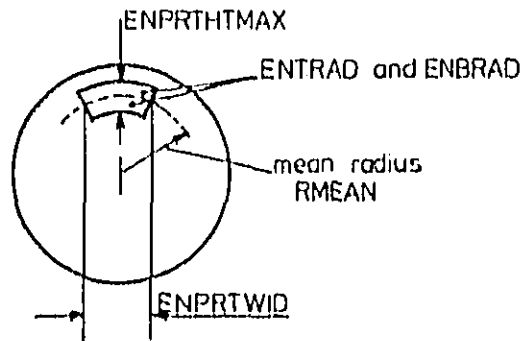

Fig. 8 elevation on face covered by rotary disc

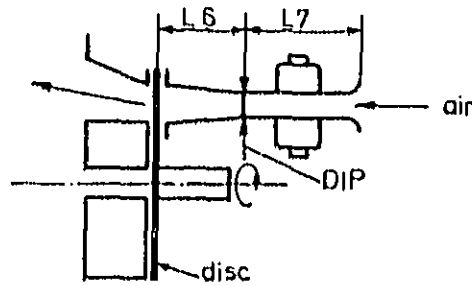

Fig. 9 induction tract length/diameter characteristics for disc valve engines.

Dimension	Symbol	Units
28 Mean radius of inlet port for disc valve induction	R MEAN	mm

Transfer Duct, length and entry areas

TABLE 5

Dimension	Symbol	Units	Data Values
28. effective area to each transfer duct at entry from crankcase (see Fig.5) individual area _A , area _B , area _C , and (usually 2A + 2B + 2C) <u>total area</u>	FTRDUCT	mm ² mm ²	_____ _____
29. centre line length of transfer duct from crankcase entry to cylinder exit (see Fig.6)	LU	mm	_____

Often individual transfer port and duct designs do not conform to the form or type indicated here. Please sketch below if this is not the case:

EXHAUST GAS TEMPERATURE, TWAL _____ °C

SHOULD INFORMATION BE AVAILABLE AS TO THE EXHAUST GAS TEMPERATURE, °C, (OR °F) TAKEN PREFERABLY IN BOX A FOR PROGRAMS GPB1, GPB3 AND GPB5, OR TAKEN BETWEEN D50 AND D60 FOR PROGRAMS GPB2 AND GPB6 THEN IT WOULD BE HELPFUL TO THE PROGRAMMER TO LIST THEM FOR EACH POTENTIAL CALCULATION SPEED (RPM) OR OTHER OPERATING VARIABLE.

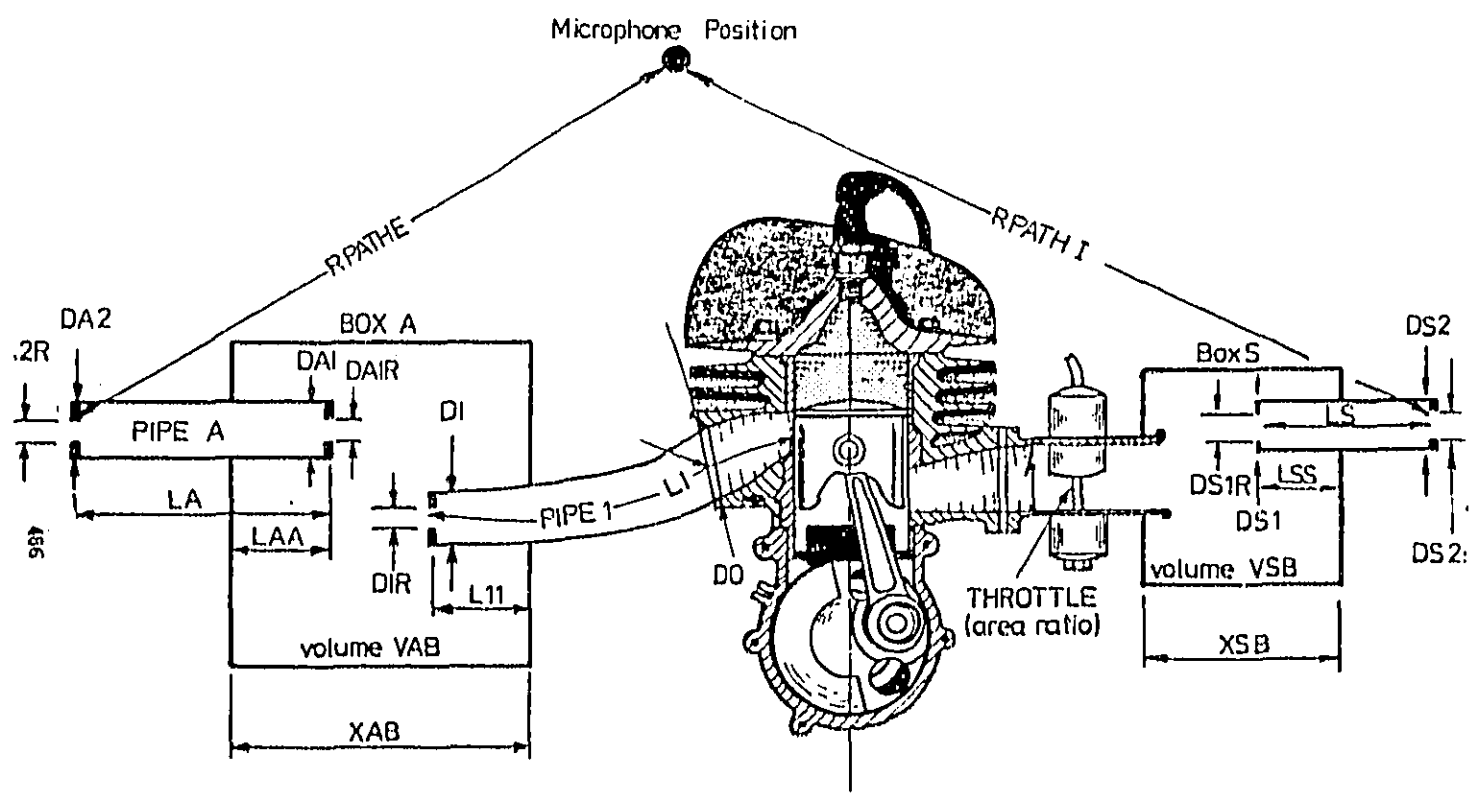

Program: G.P.B1 EXHAUST AND INTAKE SILENCING BOX PARAMETERS REQUIRED FOR PROGRAM

EXHAUST AND INTAKE SILENCER BOX DATA FOR PROGRAM GPB1

EXHAUST PIPE:

<u>LENGTHS</u>		<u>DIAMETERS</u>	
		DO	mm
LI	mm	DI	mm
		D1R	mm

BOX A DATA:

<u>LA</u>	<u>DA1</u>	<u>DA1R</u>	<u>DA2</u>	<u>DA2R</u>	<u>VAD</u>	<u>XAD</u>
mm	mm	mm	mm	mm	cm ³	mm

INTAKE BOX S DATA:

<u>Throttle</u>	<u>LS</u>	<u>DS1</u>	<u>DS1R</u>	<u>DS2</u>	<u>DS2R</u>	<u>VSD</u>	<u>XSD</u>
	mm	mm	mm	mm	mm	cm ³	mm

(area ratio)

MICROPHONE POSITIONS:

<u>RPA1H</u>	<u>RPA1R</u>
m	m

(SPARK) IGNITION TIMING: _____ °BTDC

(A/F) AIR TO FUEL RATIO: _____

REENTRANT TUBE LENGTHS

<u>L11</u>	<u>LAA</u>	<u>LSS</u>
mm	mm	mm

EXHAUST AND INTAKE SILENCER BOX DATA FOR PROGRAM GP02

EXHAUST PIPE:

<u>LENGTHS</u>		<u>DIAMETERS</u>	
		D0	_____ mm
L10	_____ mm	D10	_____ mm
L20	_____ mm	D20	_____ mm
L30	_____ mm	D30	_____ mm
L40	_____ mm	D40	_____ mm
L50	_____ mm	D50	_____ mm
L60	_____ mm	D60	_____ mm
L70	_____ mm	D70	_____ mm
		D7R	_____ mm

BOX A DATA:

<u>LA</u>	<u>DA1</u>	<u>DA1R</u>	<u>DA2</u>	<u>DA2R</u>	<u>VAB</u>	<u>XAB</u>
_____ mm	_____ mm	_____ mm	_____ mm	_____ mm	_____ cm ³	_____ mm

BOX B DATA:

<u>LB</u>	<u>DB1</u>	<u>DB1R</u>	<u>DB2</u>	<u>DB2R</u>	<u>VBB</u>	<u>XBB</u>
_____ mm	_____ mm	_____ mm	_____ mm	_____ mm	_____ cm ³	_____ mm

BOX C DATA:

<u>LC</u>	<u>DC1</u>	<u>DC1R</u>	<u>DC2</u>	<u>DC2R</u>	<u>VCB</u>	<u>XCB</u>
_____ mm	_____ mm	_____ mm	_____ mm	_____ mm	_____ cm ³	_____ mm

BOX D DATA:

<u>LD</u>	<u>DD1</u>	<u>DD1R</u>	<u>DD2</u>	<u>DD2R</u>	<u>VDB</u>	<u>XDB</u>
_____ mm	_____ mm	_____ mm	_____ mm	_____ mm	_____ cm ³	_____ mm

INTAKE BOX A DATA:

<u>Theoret(a)</u>	<u>LS</u>	<u>DS1</u>	<u>DS1R</u>	<u>DS2</u>	<u>DS2R</u>	<u>VSB</u>	<u>XSB</u>
_____	_____ mm	_____ mm	_____ mm	_____ mm	_____ mm	_____ cm ³	_____ mm

(area ratio)

MICROPHONE POSITIONS:

<u>MPATH1</u>	<u>MPATH2</u>
_____ mm	_____ mm

(SPARK) IGNITION TIMING: _____
 (A/F) AIR TO FUEL RATIO: _____

RESONANT TUBE LENGTHS

<u>L11</u>	<u>LAA</u>	<u>LBB</u>	<u>LCC</u>	<u>LDD</u>	<u>LEB</u>
_____ mm	_____ mm	_____ mm	_____ mm	_____ mm	_____ mm

FORM 10-64 (REV. 1-65)

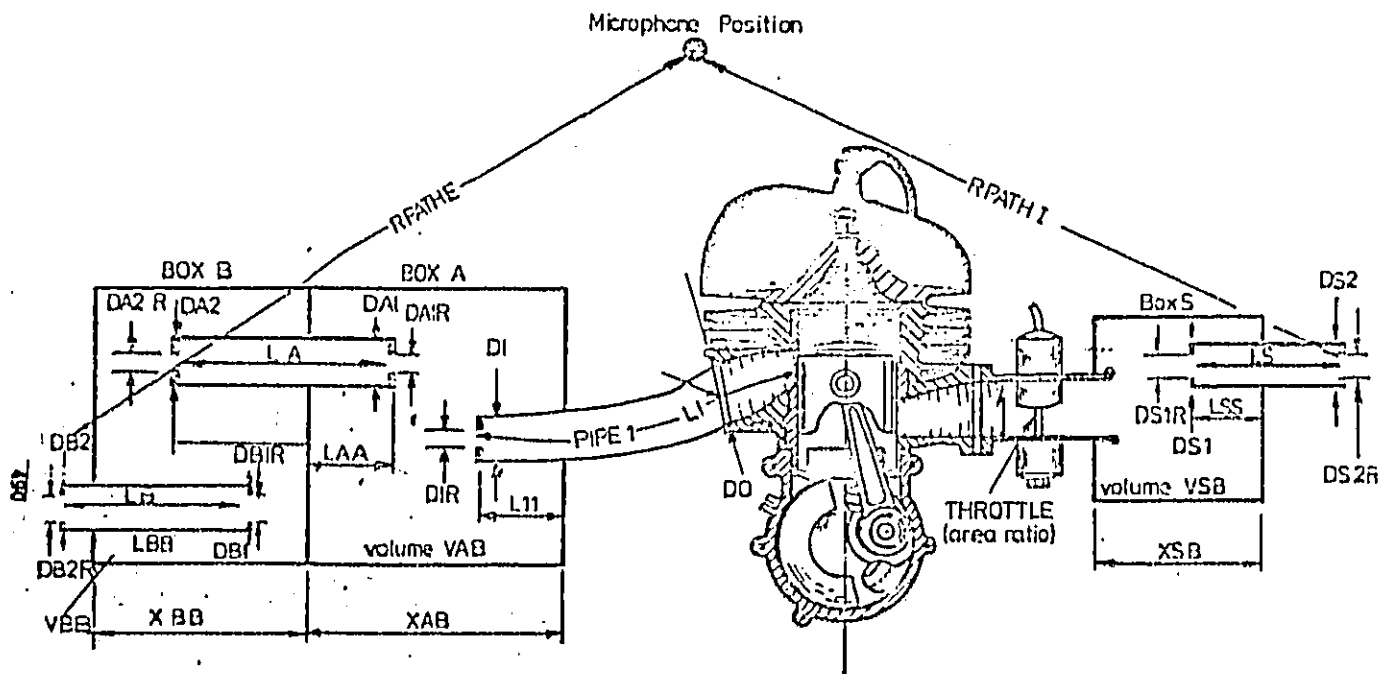

Program: G.P.B. 3 EXHAUST AND INTAKE SILENCING BOX PARAMETERS REQUIRED FOR PROGRAM

RECT 11/18 1011 P. 0000

EXHAUST AND INTAKE SILENCER BOX DATA FOR PROGRAM GPH3

EXHAUST PIPE:

<u>LENGTHS</u>	<u>DIAMETERS</u>
L1 _____ mm	D0 _____ mm
	D1 _____ mm
	D1R _____ mm

BOX A DATA:

<u>LA</u>	<u>DA1</u>	<u>DA1R</u>	<u>DA2</u>	<u>DA2R</u>	<u>VAB</u>	<u>XAB</u>
_____ mm	_____ mm	_____ mm	_____ mm	_____ mm	_____ cm ³	_____ mm

BOX B DATA:

<u>LB</u>	<u>DB1</u>	<u>DB1R</u>	<u>DB2</u>	<u>DB2R</u>	<u>VBB</u>	<u>XBB</u>
_____ mm	_____ mm	_____ mm	_____ mm	_____ mm	_____ cm ³	_____ mm

INTAKE BOX S DATA:

<u>Throttle</u>	<u>LS</u>	<u>DS1</u>	<u>DS1R</u>	<u>DS2</u>	<u>DS2R</u>	<u>VSB</u>	<u>XSB</u>
_____	_____ mm	_____ mm	_____ mm	_____ mm	_____ mm	_____ cm ³	_____ mm

(area ratio)

MICROPHONE POSITIONS:

<u>RPATH1</u>	<u>RPATH2</u>
_____ m	_____ m

(SPARK) IGNITION TIMING: _____ ° BTDC

(AOP) AIR TO FUEL RATIO: _____

REENTRANT TUBE LENGTHS

<u>L11</u>	<u>LAA</u>	<u>LBB</u>	<u>LSS</u>
_____ mm	_____ mm	_____ mm	_____ mm

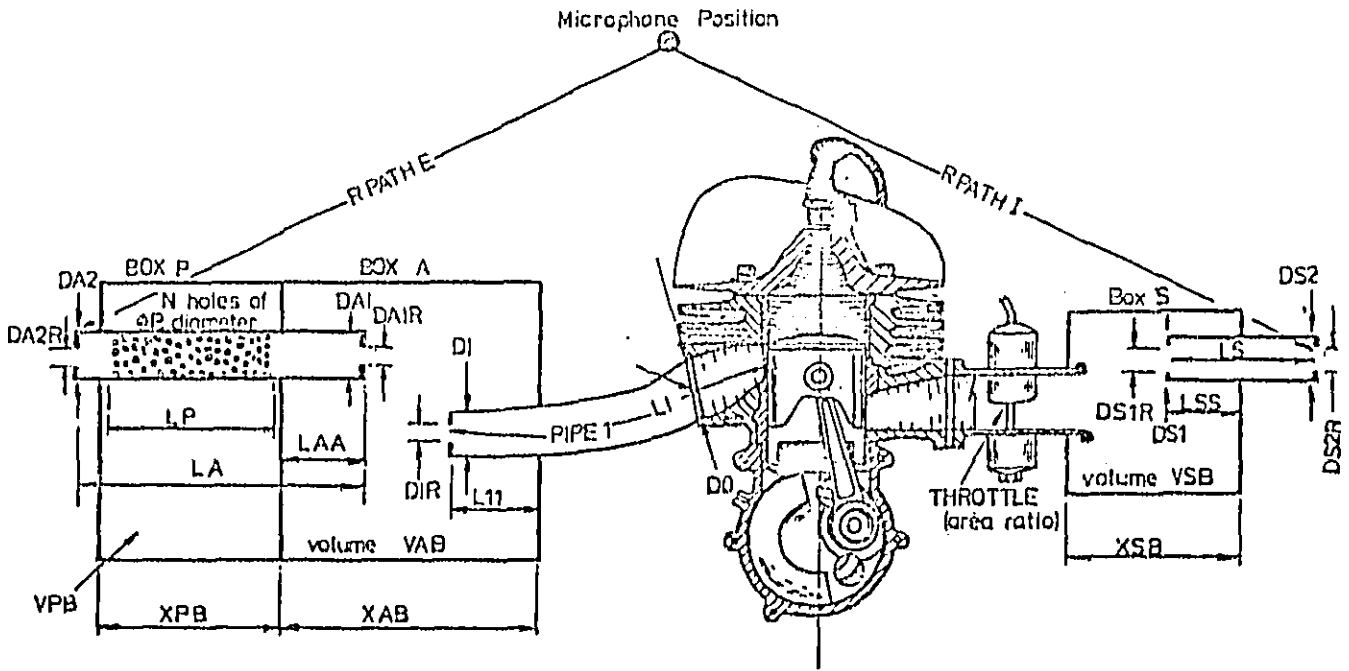

EXHAUST AND INTAKE SILENCING BOX PARAMETERS REQUIRED FOR PROGRAM GPB 5.

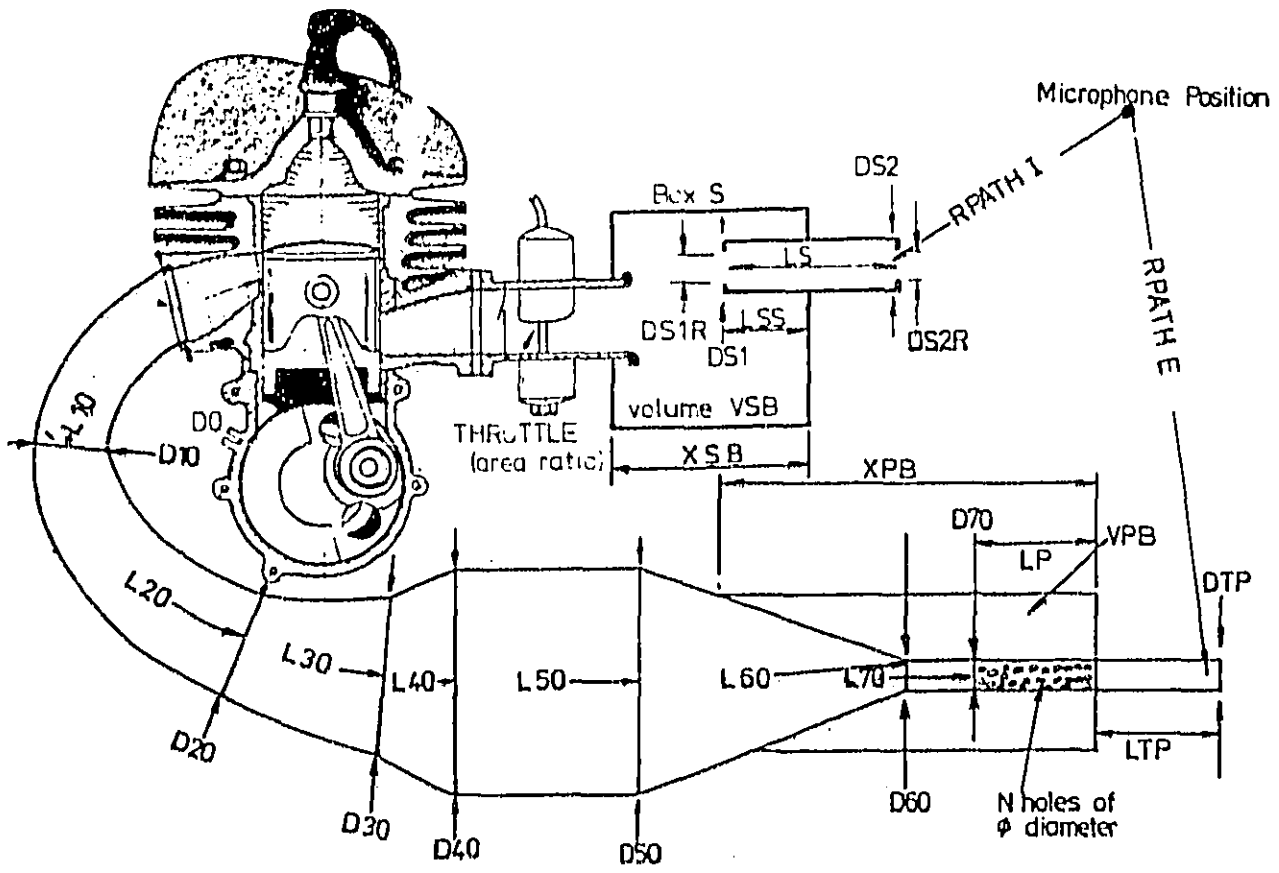

EXHAUST AND INTAKE SILENCING BOX PARAMETERS REQUIRED FOR PROGRAM FILE GPB 6 (moto-cross motorcycle). FOR PROGRAM FILE GPB 7 (for road racing no intake silencer S)

SECRET AVIAN ADI E OVER

EXHAUST AND INTAKE SILENCER DATA FOR PROGRAMS

GPB6 AND GPB7

EXHAUST PIPE:

<u>LENGTHS</u>		<u>DIAMETERS</u>	
		D0	_____ mm
L10	_____ mm	D10	_____ mm
L20	_____ mm	D20	_____ mm
L30	_____ mm	D30	_____ mm
L40	_____ mm	D40	_____ mm
L50	_____ mm	D50	_____ mm
L60	_____ mm	D60	_____ mm
L70	_____ mm	D70	_____ mm

PERFORATED PIPE AND BOX DATA:

<u>LP</u>	<u>VPB</u>	<u>XPB</u>	<u>No. Holes</u>	<u>PHI</u>
_____ mm	_____ cm ³	_____ mm	_____	_____ mm

INTAKE BOX S DATA:

<u>Throttle</u>	<u>LS</u>	<u>DS1</u>	<u>DS1R</u>	<u>PHI</u>	<u>VPB</u>	<u>XPB</u>
_____	_____ mm	_____ mm	_____ mm	_____ mm	_____ cm ³	_____ mm

TAIL PIPE DATA:

<u>LTP</u>	<u>DTP</u>
_____ mm	_____ mm

MICROPHONE POSITIONS

<u>RPATHI</u>	<u>RPATHR</u>
_____ m	_____ m

(SPARK) IGNITION TIMING _____ ° BTDC

(A/F) AIR TO FUEL RATIO _____

PANEL DISCUSSION

Thursday Afternoon - October 13, 1977

The panel discussion was conducted in two parts as follows:

Part I: Panel members were asked to discuss specific issues presented to them.

Panel Members

Dr. R. J. Alfredson - Monash Univ., Australia
Dwight Blaser - General Motors Tech. Center
Dr. A. Bramer - Nat'l Research Council, Canada
Peter Cheng - Stemco Mfg. Co.
Prof. P.O.A.L. Davies - Univ. of Southampton
Larry Eriksson - Nelson Industries Inc.
Doug Rowley - Donaldson Co.
Dr. Andy Seybert - Univ. of Kentucky
Cecil Sparks - Southwest Research Instit.

Part II: EPA representatives from the office of noise control and abatement and from enforcement, answered questions from the floor

EPA Personnel

Dr. William Roper - Branch Chief, ONAC
Scott Edwards - ONAC
Charles Malloy - ONAC
John Thomas - ONAC
Jim Kerr - Enforcement
Vic Petrolotti - Enforcement

PART I - PANEL DISCUSSION

Ernie Oddo

For the past two and half days we've listened to experts in industry and universities tell us about their work on various methodologies being studied, developed and employed to predict the performance of mufflers on various surface transportation vehicles. I believe it's fair to say that most of this work has been done to aid in the design of effective mufflers. All of us present, at this symposium I am sure, have a real appreciation for the complexities involved in dealing with the significant parameters which must be considered in any muffler performance prediction technique. Bearing in mind these complexities then, we would like to address the objectives of the EPA muffler labeling contract and the specific areas in which we need assistance from panel members and members of the audience. To open these discussions I'd like to call upon Dr. Bill Roper from the EPA Office of Noise Abatement and Control who will elaborate on these objectives.

Dr. Bill Roper

I would like to go back and read over the four objectives that I mentioned in my opening statement to this meeting which outlines the specific objectives of the EPA general labeling program, which I think is very applicable here this afternoon and applicable to this entire symposium. The first objective is the provision for accurate and understandable information to be provided to product purchasers and users regarding the acoustical performance of designated products so that a meaningful comparison could be made concerning the acoustical performance of the product as part of the purchaser's use decision. This objective I think, is a particularly important one with regard to the subject of this symposium. The second objective is to provide

accurate and understandable information on product noise emission performance to consumers with minimal federal involvement. The third objective is the promotion of public awareness and understanding of environmental noise and associated terms and concept. And the fourth objective is the encouragement of effective voluntary noise reduction and noise labeling efforts on the part of product manufacturers and suppliers. With that quick review of the principal objectives of the EPA general labeling program I would like to go back and focus on objective one which dealt with providing the consumer with information at the point of purchase-decision relative to the acoustical performance of a product. Now, that doesn't necessarily mean that a product would have to be quote "physically labeled". Information could be provided to the consumer in a number of different ways. It is essential to provide him with information on the acoustical performance of a product at the time he makes the purchase decision. We think this is an important concept. As consumers utilized the acoustical information in their purchase decision it is felt that such selective decisions will have an impact on the noisiness of products used in this country. It's a way of potentially getting noise reduction resolved without any required federal regulatory standards on the manufacturer of new products or aftermarket part replacement manufacturers. In looking at the problem from the aspect of a voluntary standard, consider that the consumer, given the right information, can make a voluntary decision on whether they want to buy a noisy product or a quieter product. Without the acoustical performance information however, he really can't make that decision. In a general sense, that's one of the principal reasons that EPA is interested in labeling vehicle exhaust systems and is collecting information at this time for use as background data to eventually put into a format for decision making within the agency.

I'd like to look back at what I consider two separate parts of the labeling background study that would have to be developed in order to have the necessary information to implement such a program. One deals with the technical performance data relative to, in this case,

MATRIX

Categories of engines vs. current best muffler assessment approaches

Muffler Assessment Approach	Lt. Truck	Heavy Truck	Auto-mobile	Buses	Motor-cycles	Snow-mobiles
Parametric Analysis	-	-	-	-	-	-
Acoustic Modeling	-	-	-	-	-	-
Engine Simulation	-	-	-	-	-	-
Standard Engine	-	-	-	-	-	-
Actual Engine	-	-	-	-	-	-
Other	-	-	-	-	-	-

INSTRUCTIONS TO THE PANEL

Please consider the following two questions for application across all surface transportation vehicles or to a logical grouping of these vehicles. (Light and heavy trucks, autos, busses, motorcycles, snowmobiles, motorboats)

Also consider approaches that:

1. Do not use the engine, such as
 - A. Parametric approaches
 - B. Analytical techniques
 - C. Engine simulation

2. Use an engine, either
 - A. Standard engine
 - B. Actual engine

QUESTIONS

1. Is there an existing bench test methodology that could be used to test mufflers, which would give values that:
 - A. Could be added to the noise contribution of other predominant sources on a vehicle, to accurately predict the total vehicle noise level, or
 - B. Would characterize the performance of a replacement muffler, compared to a vehicle's OEM muffler.

2. If not, can the panel make recommendations on the most promising bench test candidates that would meet the objectives of question one, and the stage of development of these tests.

the exhaust system; the other deals with communication of that information to the lay purchaser or user. I'd like to separate the latter one from the discussion today and concentrate on the technical performance aspect. A major part of that consideration is of course the measurement methodology procedure through which you can collect the required data. Selection of a methodology must be based on a whole series of considerations. There are many trade-offs. To name a few there's the accuracy of the procedures, the repeatability, the simplicity, the cost involved in both the operation, and the equipment instrumentation. These trade-offs will directly impact whoever is using the measurement procedures, as part of his design or production process. For the past 3 days this symposium has focused on one type of measurement methodology the bench test, to determine what was available, problems that might be involved in utilizing what is available or more basically, if such a measurement methodology was even available. This methodology referred to is the use of bench testing for determining exhaust system performance. I think from a labeling standpoint we would be looking at the muffler particularly, although I recognize that many, or perhaps all of the people that have participated in the symposium have stressed the importance of looking at the total system. I think from a labeling standpoint the most important part of the exhaust system is the muffler, although you'd have to consider the total system in developing the information base to properly identify or characterize the muffler. I think another element here is the fact that in carrying out this program, conducting this symposium and investigating what procedures are available for measuring exhaust system noise we at EPA recognize that the industry and the people such as yourselves, who have done research in this area over the years are the experts in the field. You are the ones that know what can and can't be done both from a theoretical and a practical standpoint and we would like to benefit from the knowledge that you have and receive recommendations from you based on the best information that's available on what you would recommend to EPA as far as any measurement methodology for vehicle exhaust systems is concerned. Now, we get down to the real

practical aspect of the task we at EPA have to accomplish, which is to look at specific exhaust systems and to determine the most practical, available test procedures to use, to obtain representative acoustical data. I have broken out here on the viewgraph the 7 major categories of products that we are looking at at this time. I would like to focus the attention of all those on the panel and the audience on these 7 categories and based on the information and reports that we've had in the last three days I would like to challenge you to come up with your best recommendation on how we might measure and characterize muffler performance on these 7 categories of vehicles. Now, I recognize that none of the presentations have specifically broken the products out this way although I think there are possibilities here for combining certain categories. I would be very interested in the comments that might come forth on these particular applications. Now, I have gone ahead and taken the liberty of using some of Larry Eriksson's breakout of a general approach to muffler assessment and listed some of those down the vertical axis here and I guess the question comes down to how much of that matrix can we fill out? What's available today? And perhaps if there are two or three procedures available for testing in one category here, maybe we should talk about a ranking of which of those three are best for use in that particular application. I think as we move into that discussion, since you are the experts in the field, you can also interject your concerns for the other elements of measurement methodology that have to be considered at some point such as simplicity, cost, accuracy and similar things. The EPA program, from a time standpoint calls for our contractor McDonnell Douglas Astronautics to pull together and present to us in approximately one month, the recommendations from this symposium, along with their own views on this question. These recommendations will be used by the EPA to make decisions on a procedure or procedures to be used in our testing program for measuring exhaust system muffler performance; a procedure other than for measuring total vehicle sound level. Our contractor will be conducting tests using both total vehicle and whatever other bench test procedure we have selected, starting the first part of next year. I have briefly summarized the program schedule that we're working under and the purpose and objectives of this symposium.

Our primary objective in this symposium is to come up with the best available test procedures to be used in assessing a muffler exhaust system performance, other than by using total vehicle sound measurement procedures. So with that challenge to the audience and the panel I'd like to turn the session back over to Ernie Oddo.

Ernie Oddo

I'd like to amplify on one of Bill's statements. Currently in our contract we are going to test vehicles in each one of these categories that are on the board. We will also test, a minimum of three after-market mufflers on each one of these vehicles, using the currently most applicable total vehicle noise measuring procedure, such as the SAE J-336 for trucks, for instance. Then we will take those mufflers off the vehicle and test them using a "candidate" bench test methodology. This is part of the test plan that is in the current contract. Continuing then with the panel discussion I'd like to flash on the board the questions that we gave to the panel at lunch time to review. We'll give the audience a chance to read the questions. Then we will flash a viewgraph on the screen showing a matrix of transportation vehicles versus various muffler assessment approaches we would like considered by the panel.

Cecil Sparks

Looks to me like it addresses itself to the evolution of the bench test facility which will be used for actual predicted purposes, that is to predict the sound level coming out of the thing which in essence means we can then put a label on this muffler that will define the muffler, the exhaust system, the engine, the whole thing. In such cases, it appears to me that your label's going to be bigger than your muffler in the sense that if you consider all the possible parametric variations involved you're going to include in the label, including the testing facility, the wide variations and engine operating conditions and the exhaust system, etc.. The approach inferred then is one of predictive rather than just a bench test facility that will say that this is a reasonable quality muffler and as such will have to be a label of the system rather than the muffler itself and while this kind of thing it seems to me is theoretically possible

in that you can build a source simulator for any given engine to cover a wide range of conditions put simulated exhaust systems, etc. on it, seems like it would be much simpler just to test it on the vehicle.

Ernie Oddo

I want to clarify one point there, by labeling we don't necessarily mean physically sticking a label on a muffler. We have a much broader description of labeling. Labeling could be just some identifying numbers on the muffler similar to what is done today. The numbers or letters would identify the manufacturer of a muffler which then could be traced back to the manufacturer's catalog. The catalog which most manufacturers currently issue would have all of the information that you have discussed. This is just one alternative.

Cecil Sparks

The other alternative would be to categorize it in terms of the inherent passive response characteristics of that particular configuration but again you would need the same kind of information we're talking about if your intent is merely to be able to predict what the ultimate noise level at a given application will be rather than say, okay this is a hospital type (stationary) muffler or something like that.

Ernie Oddo

As an example, I would like to reiterate that which Doug Ralley from Donaldson presented. That approach is similar to what we are talking about, for trucks. In other words, Donaldson has all kinds of information computerized on tab runs and in catalogs, which take into account back pressure and all the other parameters that we discussed. Their program considers the specific parameters such as engine back pressure, pipe length, etc., and then indicates candidate mufflers, for that application.

Cecil Sparks

That was the point I was trying to make, do you do this with a bench test facility or do you use the actual installation?

Ernie Oddo

Okay, well that's the question we're posing here to the panel and to the audience today, considering the broader definition of bench testing which could be any of the categories up on the board.

Dr. Davies

I wanted to step back two steps first - I know Bill Roper said that he wanted us to concentrate on technical performance data and that communication of information concerned was of secondary importance, well already we've seen you can't separate the two, they're a combined exercise. You can't really decide about the technical performance data you're going to produce without taking the communication problem with it so you can't divorce these. They're part of the same process in the first place. The second point I'd like to make is that when you come to a labeling procedure and we've heard the difficulties of labeling muffler units on their own you really must look at the system and all these other complications and that there isn't such a thing as a good or a bad muffler, it just depends on how you use it. The consumer and if you think of the consumer in a simple level, and that's the housewife in her house, she has the same problem, she has to buy a cooker and a dishwasher and various other things, and operate these and get them to perform certain tasks, she makes a distinction, she knows what she wants, and so I think that what you've really got to do is to think of the two together, you've got to provide technical information that's understandable. It can be complicated, I mean you are going to look at the sales feature on some of this equipment, I don't understand it. The housewife does. You don't get bugged up on the technical problems too much, but you put the others on the consumer to say, all right we've given you this information and it's

up to you to make proper use; what he's got to be sure is that the information isn't deliberately misleading. I think that's the first, and secondly the information is sufficient for him to make a qualified judgement. Well now, that's one part of the problem, the second part of the problem ... that I'm horrified by this here table or matrix, because it's quite clear, and I'd like to add another category to the list, why we've got recreational vehicles there because they really cause a lot of problems.

Ernie Oddo

They are not in our contract.

Dr. Davies

They are not in your contract? Then let's exclude these explicitly. The second thing is that we have a very wide range of engine types and I don't see how we can come to a simple and meaningful way, consumer oriented way of describing the characteristics of these systems over this big range. For two reasons, the guy is not going to be interested if it isn't tailored to his requirements. He's not going to go through five pages of data just to get the two lines he's interested in. So what you've got to do is to come up first with a clearly defined classification system. It's not difficult, it's here, heavy trucks, you might put light trucks and autos together, buses are a special problem because buses are operated on the whole by corporations and the corporations have the technical expertise to make decisions. And then you've got the other problem, the snowmobile, the motorboat, the motorcycle, the semi-recreational vehicle and also you've got the ordinary driving car and also our washer or our cooker or whatever we have at home, in our house. I think we have to produce a different labeling system to suit the application and I think if you start in that direction you might make some progress.

Ernie Oddo

First of all we do have recreational vehicles in our contract, motorcycles and motorboats are recreational but on your point I agree with everything you said Professor Davies, concerning this matrix, we don't in any way intend for muffler labeling information to be collected in this format to be passed on to the consumer. We just present this information in a matrix format for the panel's consideration; as an easy way to keep in front of you all the various possibilities that we would like you to consider. We realize, of course, that for light trucks one or more assessment approaches could be used. For heavy trucks or automobiles, the same thing holds true. The question is, can we group the engine categories above and then use one of these particular approaches to handle two or three or four of these vehicle categories?

Prof. Davies

What I should have been clear in saying is that I think that as well as this categorization you really ought to categorize the consumer or the purchaser or whatever you'd like to call him. That after all the fleet operator represents one category and he wants a different sort of information than the individual operator or the private individual. You might think again that you really have a different labeling procedure for these three categories, because they are different.

Ernie Oddo

That's true and that's why we try to separate the two issues - one being the technical. We feel that once we have good technical information obtained from a good bench test methodology, the transmission then of that data or information to the consumer, is another problem, we recognize that. We are also open for suggestions on the best way to transmit information to consumers, but I think the first step has to be the technical question, do we have a bench test methodology that would give us good, valid, accurate data to do with it what we want to do?

Prof. Davies - It's this question of accuracy that bothers me. If you'd left out that word I'd go along with everything you say. I think you have to define what you mean by accurate. I think it's got to be convincing. Convincing is a different overtone. The consumer, the guy that's going to fit this to his car or fit this to his truck has to convince himself that what he does has to comply with regulations and he needs information that will convince him that what he does is a sensible approach to solving the problem that he's up against - regulations. That's what he wants. Accuracy really doesn't come into it. He's going to depend on the certification provided by the manufacturer.

Ernie Oddo

That's where we want to apply the word accuracy. Not really to the consumer, we're really interested in the manufacturer guaranteeing that his product when used on a certain vehicle is going to do what he says it is going to do.

Dr. Brammer

I believe that the sort of question the consumer is probably going to ask is something very simple such as, is this replacement muffler equal to the one I have on my car or better, or is it worse, and if these are the type of questions one wants to obtain answers for then we're really talking about a relative measure of muffler performance; we're not talking about an absolute measure and in terms of questions that are posed here, this moves us more towards B than A perhaps and also it enables us to, if we think about it, we can now start running some form of test as yet undefined, in which we can replace single components, compared with the original existing components, and see the effect of them relative to the original muffler. I think we have to think a little bit about the type of labeling that will be used and the sort of questions that we

want to answer otherwise I don't see how we're going to get started on this particular problem but here's a notion that I think we could usefully pursue. If one tries to answer questions of this type but it does get away from a lot of these problems of predicting the noise of the vehicle and things like this and the accuracy of the measurement that was giving a lot of concern and rightfully so. If I had to rank order one A or B of which I think is most important to the consumer I think in terms of questions he's asking from a replacement piece of equipment, I'd rank B above A at this point in time and let that influence the choice of measurement technique that I would go for.

Ernie Oddo

Any comments?

Doug Rowley

Bill Roper laid down quite a stiff guideline for us and I think I'd like to get them a little bit stiffer. Talk about this accuracy thing and I'd like to ask, accuracy to do what? What are we really trying to do? By that I mean what level are we trying to control overall truck noise too? Then we can talk about whatever the exhaust system has to do. Can you comment on that Bill? Can you follow the question. In other words, somewhere along the line I'm trying to get someone from EPA to tell me that you'd like to control the noise of the new 1978 trucks once they get in use, to some level. Then, when a fellow starts looking for a replacement product he's got some guide lines.

Bill Roper

Okay, in response to your last question, you're right, the new medium heavy truck standard is one that applies to the date of manufacture and we have an in-use standard for interstate motor carriers which is 86 dBA for speed zones less than 35 mph, there is a gap so to speak in the Federal program although not in some state programs, I understand, as to the in-use level that would be applicable to the medium and heavy truck, say that's manufactured at 83 dBA level beginning 1 January 78; there is no Federal standards other than the 86 dBA pass by, now we have under way right now a program at EPA developing the background

information that will be necessary for revising the interstate motor-carrier regulation with the intended purpose at this time of setting that interstate motor carrier standard at a lower level which would be equivalent for an in-use truck to the new truck standards. In other words a truck that is manufactured to meet an 83 dBA newly manufactured standard would then be required if operated by an interstate carrier to meet some equivalent standard while in use. Now, it may be the same level, it may be slightly different because there's a different measurement methodology involved. But yes, we are addressing that now. In regard to the labeling aspect I think we're talking about more than just a label that identifies how close or how a product complies with an existing standard because in some of the areas there may never be Federal standards for those products. We're again focusing on the information that describes the acoustical performance of that product to the consumer so that he can consider noise as one of the elements he thinks about in making that purchase decision. I guess I would also want to talk about two different ways that you could look at two different types of information that could be used for a basis for labeling. One would be if you're comparing system A with system B or system A with the original equipment, and that's such as you were mentioning, a comparative type of information. The other would be how does it compare with the total system or total vehicle performance; in other words, given this exhaust system, how is it going to affect total vehicle acoustic performance. There's really two different approaches there from the EPA standpoint we are not locked into either approach. We're looking for the one that makes the most sense. There may be implications, depending on which kind of approach you take as to what's available from a measurement standpoint, to provide the tool to develop the data for labeling. That's one element that I'd like to hear more comment on. Considering these two general types of approach, to collect the necessary information for labeling, which one has the necessary measurement tools commensurate with it to provide the data, at this time?

Cecil Sparks

You could go a couple of ways in that regard, again I think that if you're trying to use a bench test facility or evolve one whereby you can predict what this particular muffler will do on trucks X, Y and Z, etc. you've got a pretty tough row to hoe. On the other hand if you can evolve the system of labeling where you label the truck and the muffler that this truck has, then, when a replacement muffler is used, class G31 and 4XB2 or something like this then in essence qualify your mufflers for those various applications. Now that is something that seems to me would be a practical approach. But again, perhaps you don't need a bench test facility to do this you could qualify the muffler then as being original equipment or better. And then you put in your owner's manual which mufflers you can use, as possibilities.

Ernie Oddo

That would lock it into OEM only and how would the replacement manufacturer, for instance, comply.

Cecil Sparks

They'd just have to qualify their muffler for that application.

Ernie Oddo

Right, and that's what we're talking about. Qualify it how?

Cecil Sparks

On the vehicle.

Ernie Oddo

Okay, that's true, that is definitely one methodology that can be employed and we know it will work if you test every one on the vehicle, but we are looking for methodologies other than vehicle testing, to supply performance data on mufflers.

Cecil Sparks

The point is though, if you build a bench test facility whereby you're able to predict this muffler's performance on this whole broad spectrum of truck configurations you've got a horrendous job.

Ernie Oddo

That may be the case.

Peter Cheng

I agree that while the best thing is to put a muffler on each truck model. We've got two problems here. First, even OEM truck manufacturers cannot test the mufflers on every truck model. Say one particular truck model, they may have 80 to 90 different combinations. Some of them have a fan clutch some of them have different fans, some of them have transmission boxes, etc. As to the second question, if we are going to test the muffler on the truck who is going to do it? Who's going to pick up the vehicle? There are so many aftermarket truck muffler manufacturers. Do each one of them have the right to ask OEM manufacturers to test mufflers on every one of the OEM truck models?

Cecil Sparks

More people would have access to the trucks than they would have the facility, I would think.

Peter Cheng

Well, from our experience it's very difficult to get a truck. Most likely, we would like to test the muffler on the new truck because the other noise sources were controlled when the truck is relatively new. And usually, the dealers would not allow us to get the new truck to test and another thing is that talking with some of the OEM truck manufacturers when they want us to test some truck, especially on back pressure, they would specify the truck must have gross vehicle weight. We have to put say, a few thousand pounds at least on the

truck and no local dealer or whoever would like to loan us a truck by putting a few concrete blocks on it. I am looking at this problem from the other aftermarket companies' point of view. We are also in the OEM business and first of all, our experience again is limited to heavy duty trucks. I don't know anything on snowmobiles, etc. The heavy duty truck is different from the passenger car in one sense in that the customer is more knowledgeable than the general consumer. It is a different type object. Second of all I am not saying that they understand exactly what dBA is, etc. but at least everyone of our distributors has a noise level meter they can somehow crank up an engine and run some tests. And then, let me view the problem from OEM market experience. I don't think there is 100% satisfactory bench test method. Because of the pipe length, etc., but the SAE test procedure mentioned by Mr. Larry Erickson this morning, I think that's a good compromise between practicality and 100% accuracy. And, we also have a lot of experience on judgement of whether the muffler we sent out to our OEM customer will pass the drive-by test or not. We have a very good idea if it will. We're just like Mr. Doug Rowley said when he got 95% accuracy. I don't know whether I would have 95% accuracy or 80% accuracy but I tend to agree with him that there is some correlation between a bench test and drive-by test. If we cannot get some kind of ball park feeling from our bench test then the OEM truck muffler manufacturers simply would not be in the business. We cannot send five mufflers for our customers to test and for them to pick one. They are not going to do that. We send him one sometimes at most two and we make our best judgement whether he will test it or not, also, we do not send one muffler to one manufacturer. We send a muffler to possibly a lot of manufacturers. And from our experience if the muffler which we judge is a good muffler probably will pass the test with a lot of our customers. On the other hand, a bad muffler probably will not pass the test.

Ernie Oddo

Thank you very much, Peter

Larry Eriksson

Well, I had a few general observations, a little bit over what Peter said and what Cecil said, looking at these vehicle categories one observation I'd like to make most, is that many of these categories are products that either have been or will shortly be governed by some new product noise regulation by EPA. And I'd like to focus on that a little bit. One of the observations I'd like to make is that for those products I personally don't see the need for muffler labeling for the new products and I think this is an important point. We're talking about a truck or whatever that is already subject to a new product regulation. I for one feel it would just add complexity to also ask for a label on the particular muffler used on this piece of OEM equipment. It's already meeting specification for the overall vehicle. Accepting that point then what that leaves is the aftermarket. And, in terms of the aftermarket the only observation I can make is if we are setting levels for overall vehicles, new products that are as stringent and as accurately measured, etc. as we are for trucks, buses, or what have you, it seems to me that any aftermarket evaluation procedure measure ought to be at least comparable in accuracy. We shouldn't give away an awful lot in terms of the aftermarket measurement procedure. Essentially what we ought to be shooting for is something that is more or less equivalent to OEM and the OEM unit that the OEM equipment has. In the sense that we don't want to allow any degradation of that product, that the EPA's proposed regs already have included some aspects of not allowing any degradation. I frankly see the requirement in the aftermarket ending up one way or another. Saying in so many words it's going to be about like the OEM unit was. Accepting that fact and the fact that you want an accurate test it seems to me that you're going to be looking at an actual engine test of one sort or another. Now, I agree with Peter, I think the SAE procedure that we have worked up is probably not too bad a compromise, but whatever you come up with I think it's going to have to be something very similar to that in order to obtain the kind of accuracies to be

consistent with the rest of the program. And, I have not seen in any other presentations including my own that the other four techniques listed here really provide accuracy that is at all comparable to the rest of the noise program, that is at all comparable to the type of thing we can achieve in the SAE type procedure, with the type of engine dynamometer and real engine close to real system type of test. Now, if you're still with me on that where that leaves me, is saying that okay, we're going to do real engine testing, we're going to test on something like and SAE test, but what about the multitude of combinations. It's been stated, it seems to me if my observation is correct, that there is no practical way to measure all combinations that exist and so it strikes me that we're going to be in a situation where some kind of certification that it meets is a preferable route and then a test program would have to back up that certification. The burden would be on the man who certifies it, to the muffler supplier to have his engineering house in order sufficiently so he can certify it and be reasonably confident that when he gets around to testing it on an engine or when somebody else gets around to testing that particular situation on an engine that within some tolerance it does in fact follow what he said it would. So those are a bunch of observations which are connected.

Ernie Oddo

With reference to Doug's comment before on the SAE procedure, on the accuracy of that procedure, would you still consider the new SAE procedure accurate enough for this purpose?

Larry Eriksson

I didn't really disagree that much with Doug, maybe it came out that way I don't know. The procedure is a very good procedure. It's an accurate procedure in a sense that certainly I think all of us in the muffler end of things at least in this panel, are using, something very similar to that procedure today in our muffler testing and it certainly does correlate in an indirect sort of way with the kind of measurements the vehicle manufacturer might be making. I guess I'm

like Peter, I don't know what percent is exactly, the correlation, but certainly we do supply units to our customers, and often times there are no problems in terms of correlating our numbers with their numbers. Occasionally, of course, there are, but there is certainly room for improvement in that particular area. However, it seems to me it's far-and-away, from a technical point of view, the best way to do it, that we've found and usually, the correlation is quite satisfactory.

Ernie Oddo

Thank you, are there any comments?

Dr. Robin Alfredson

It seems to me that a fairly easy measurement to make in the laboratory anyway is the measurement of transmission loss. And the question we really have to work out is how good is transmission loss a measure of performance on an actual vehicle. My guess is, and it's really only a guess, that transmission loss is probably not too bad for the large multi-cylinder engine situation. That's only an intuitive guess.

I believe in the single cylinder or two cylinder case transmission loss is very unreliable. I suppose on the average if you're measuring transmission loss for a large multi-cylinder type of vehicle that might give you an indication of the performance. A little bit like having your feet in two buckets of water. Have one foot in a bucket of water that's freezing cold and the other is boiling hot, you can say on the average it's warm but it's hurting quite a bit. I don't have any strong feelings, perhaps some of the manufacturers might have. If you do have a good muffler, and I imagine that means good in terms of transmission loss perhaps, can you be reasonably certain on a large number of vehicles that on the whole it performs well. My feeling is that probably with a larger multi-cylinder engine that would be the case but certainly not with the smaller configurations.

Doug Rowley

I'm not going to try to answer that question. I don't happen to agree with that. I'd like to go back to Larry, Peter and Bill, obviously one of the reasons I wanted to know what your goals are is to establish a point that we will be faced with replacing a product that is equivalent to the original equipment and yesterday Bill Roper mentioned something about replacing the exhaust pipe with an equivalent to the original equipment. I think one thing we as part of the industry do not wish to get into is placing a standard on the exhaust system. Really, what we're trying to do is control overall truck noise, which, perhaps exhaust noise is a very significant part. The question is, and it could be a little bit ridiculous, are you going to put a standard on the mechanical noise in the engine, intake noise, fan noise and etc. Well, this is pretty much what I'm driving at, I do feel that if our catalogs should say, as a guide to the user, that this is equivalent to the original equipment, really to carry that on further, is there a need for a specific type of evaluation method. Perhaps there is, but you're coming up with an assessment. I could perhaps look at a product and say well, yes based on a lot of experience that's going to be equivalent to original equipment. Do you get what I'm driving at here Bill? For instance, to meet the 83 dBA requirement we may have an exhaust system that controls the exhaust noise to 80 dBA or in another case we have to control the exhaust noise to 70 dBA. A vast difference probably in the size, shape, weight and the cost of the exhaust system. And really, when you get right down into the trucking business, this is the name of the game. They just get by with as little as they can possibly use.

Bill Roper

I think in your comments you brought out one of the points I think important. That is, knowing what the exhaust system will do on a particular truck is vitally important to the person who is using that truck. You mentioned the one case you cited. The one case might be an 80 dBA muffler and the other case was a 70 dBA muffler to meet a

particular desired level of total vehicle noise. So it's vital to the user of those two trucks to know which muffler or which exhaust system to apply. And I think that the general thrust of a labeling program is just that. To provide to the purchaser of the product, information that will allow him to evaluate the acoustical performance of the product he is buying along with the other things; cost, or whatever. I don't know, I guess it's not true that in a general sense the quieter muffler is always the most expensive, sometimes it isn't. So he would have the acoustical performance available along with other information when he makes a decision. The other point you raised there, is other components of the vehicle are important. As I recall, my opening remarks pointed out a couple of things that are particular to the exhaust system. That is, one, it's an important source of noise. Two, is that it is replaced on a cyclic basis throughout the useful life of the product so that it is something that a user later on in the life of that vehicle will be replacing and if it is replaced with a system that is acoustically louder it's just a louder source of noise in the environment. Being in the noise control business we're concerned about that, so it's for that reason too we are interested in coming up with a way of defining the performance of replacement parts. Exhaust systems fall into that particular category of a product that is in fact a replacement part, to a total vehicle system.

Dwight Blaser

I think the one thing that baffles me a little bit on what seems to be charged here of this three day symposium is that maybe it's the next to the last line there on the screen, everything seems to be pointed toward characterizing the performance and we all seem to be charged with which technique is the best to do that. In order to decide which technique it seems to me, that first you have to define which performance parameter are we going to use to characterize it. Let's even limit it to the acoustic performance. I feel certain that of all the bench tests, analytical techniques, all the on-vehicle tests, they've all been carried out in a very systematic careful manner, they're all relatively accurate for developing data which

refers to a particular performance parameter. It looks to me like what we really have to do is to define or decide which performance parameter first then maybe we can back off and look at which technique, if you wish, is the most accurate, to measure that parameter.

Ernie Oddo

Respectfully, I am asking you the question back again as a panel. Taking into account that you've done a lot of research, a lot of work in this area, and you're familiar with the important parameters, which should or should not be included in any bench test methodology. Can you eliminate as maybe less significant some of these parameters to come up with a simpler bench test and still meet the objectives here.

Dr. Davies

I don't really feel it's helpful to repeat what one's said but I think a lot of things said in between on a remark I made earlier and a remark I make now is along the same lines. The point is, if we're going to get anywhere, that we've got to state some objectives very clearly and this is what Doug Howley said. We've heard about heavy trucks mostly, in this discussion. That's only one part of the problem. Now we know what the objectives are there. The operator has got a tough job. To meet the noise requirement legislation. Because we know the engine noise that's the carcass noise is so dominant, that's one particular problem, and the methodology you want and the problem that the muffler designer is facing is in one category. Now if you talk in terms of total environmental pollution, the private automobile, the problem is quite different, that is an exhaust noise dominated area, as far as the environment is concerned in general. That's very much more difficult I think, the replacement problem, because there are more replacements, that are going to happen in the life of the auto. Secondly, the replacement's going to be made in a much more arbitrary way. A private individual's going to put a replacement part

on, that he can get cheapest and quickest to getting by, I mean that's the answer for the average user. That's a different problem and if you're going to try to come up with a methodology or a test procedure I think you've got to look at each of these categories on the list and in the matrix and say allright let's pick the parameter for that one and place the methodology on that one and let's go on to the next one and look at that and then you make progress.

Ernie Oddo

Good observation and if you'd like to continue that discussion --

Larry Eriksson

To carry on a little bit on what Dwight's comment was, which I think I heartily agree with. It's very difficult I think to separate the technical questions from questions of the objectives and what the EPA's trying to accomplish, why they're undertaking this program in the first place. I think you've got to get very specific about why this program is being done. Specifically, what it's trying to respond to, what it hopes to accomplish. I know with our own company there's one excellent way to waste a lot of time and get a lot of wrong information and that is one of the personnel in our company, whoever it might be, someone from our sales group or engineering group walks over to some guy in our research department and he asks some question of our research guy, how do you do this? And unless he gets very specific about what he's really going to do with that information and why he wants it in the first place, chances are they're not going to talk the same language at all, they're going to get a very strange answer. And the research guy may be operating from a totally different point of view. I think the only way we can work is you've got to have a person who's asking the questions to give you all the background. What is he really looking for? What is he trying to accomplish? And this has been lacking. I have felt this is needed for us to have a better idea of exactly why we're trying to do all this. Now, that's kind of a cop-out. Now part 2 is the SAE subcommittee to a certain extent answered that from their

point of view. Their answer from their point of view was, we want the sound pressure level produced by that exhaust system. Our subcommittee had to deal with that, not from a government regulatory point of view but from the point of view of a group of engineers trying to provide some reasonable characterizations of exhaust systems so we had to answer questions from that point of view. Regulatory agencies are something else again. I have not heard that, from the EPA. We were looking forward to the question session with EPA, because that was to be my question.

Peter Cheng

I'm not trying to answer Larry's question to EPA for EPA but I imagine one of the objectives in the muffler labeling proposal probably is because there are many mufflers on the streets which are basically tin cans. We can label mufflers in a very strict sense, put an A, B, C, D on it or we can label the mufflers in a rather general in a broad sense. That is, in the very first step the EPA would require each aftermarket muffler manufacturer have a good test facility they would have to know what they are doing. The EPA can somehow certify their test or their test methodology. In addition, EPA would have to require the aftermarket muffler companies to report the test results to their consumer. I personally believe that EPA should adopt these two steps and then wait for awhile and then see whether there is indeed a need to label the mufflers in a strict sense.

Dr. Seybert

We talked a lot about non technical things and perhaps I'm not quite as familiar with the rest of the people in regard to some of these questions. Robin Alfredson touched on something I don't think that we have received a satisfactory answer for and that is, how can we use a basic muffler descriptor such as transmission loss. Maybe not on its own, but modified according to some particular configuration with

exhaust pipe or tail pipe lengths and engine configuration, as a descriptor. I don't think anybody has really demonstrated that this cannot be done. If we do have a proper descriptor for each of the subsystems of the overall exhaust systems. Certainly transmission loss and insertion loss have a lack of correlation. Transmission loss with more definitive information on the rest of the system may be an adequate descriptor. We haven't proved that it isn't. That's one thing I would like to see pursued.

Prof. Davies

I've disagreed with Robin before so I'll disagree again. Can I refer back on the three days past, to my original presentation in which I pointed out that an outstanding problem, and this affects the issue on technical accuracy, is that we don't really know how to categorize the source and so we're really in the dark. You categorize the source and you can then categorize the rest of the system. Fine, if transmission loss is it. That's quite satisfactory, that's nice as Charlie pointed out, it's invariable for a particular unit, that's nice too, you can label it, as he said gold plate the label and shove it on there. That's grand, vastly, but we're not in that position. In fact I don't know that we ever will be because if you take the top line operator it keeps these vehicles on the top line and all that jazz then you're talking turkey. If you're taking the average user and particularly, and we haven't talked about cars much in this discussion, the average driver of a family car, he's not going to keep that in the shape that all the accurate measurements and everything else are made in. And so, talking about one or 2 dB or high accuracy or whatever is meaningless, it doesn't mean anything. Because the source is not going to be anything like the OEII source the vehicle was when the vehicle was categorized. It's going to be different. I think you've got to go back to something that will provide the consumer with the data rather like the truck operators are provided with data by the equipment manufacturers and they make the decision which muffler to buy and to put on their particular truck. It's their decision, in

the long run. You provide the legal authority, the police or whatever, with a test procedure like the 20 inch procedure for deciding whether the individuals are complying with the law. And, we've heard about the difficulties of providing a simple bench test procedure for that. So that's what you've got to do and I think you've got to be specific. But there's no way of stamping a label on a particular product and say that's going to always be satisfactory. It's been said several times and I agree, there's no such thing as a good muffler or a bad muffler excluding the tin cans. Without saying where and how and why you're using it.

Cecil Sparks

I just want to second that and the way your first question is worded it says that the prediction has to be in a form of an actual noise level so it can be added to the other noise levels from the other vehicle sources so we agree that some of these more erudite definitions of the inherent muffler characteristics much more adequately characterize muffler performance than something like insertion loss. My wife isn't going to be able to use something like that and very few people will. So it's more of an evaluation process of what you do with the data after you get it more so than how you get the data.

Ernie Oddo

That's true, that's an important part of the contract. Would any of the panel members like to comment on those two questions relative to any other vehicles other than autos and trucks which is more or less what we have dwelled on here.

Dr. Alfredson

I thought I'd just make a point here which really isn't very relevant but the manner in which a vehicle is driven, can make quite a difference to the amount of noise. This is particularly important for the recreation vehicles.

Dr. Brammer

A comment on the small engine vehicles, I think the technique employing some form of engines is highly preferable to those that don't, so if you want a constant measure I would use one of those. I don't know whether the panel agrees, but we've really wandered around and I don't think we've got anywhere. I think if one simplifies the question perhaps in the way I suggested right in the beginning we might lead off to some direction, that is of course assuming there is a need in some way to control the production of mufflers which is what it boils down to. Control the performance of mufflers I should say. This can be either by some form of self certification that this muffler is better or worse, backed up with some test procedure which could be used as a method of arbitrating between a manufacturer perhaps that claims it is equivalent to the existing one and perhaps a consumer or in this case the regulation agency that claims the muffler is in fact superior or inferior. All of the qualitative descriptions that I have used will be turned into quantitative terms such as equivalent could be for example ± 5 dB of original equipment for example, and I think that if we're going to make progress on these questions I'd like to see us sort of direct the discussion a little bit, somewhere along these lines.

Ernie Oddo

I don't know if panel members are familiar with the two testing Institutes in France and Germany. The one in Germany I'm referring to is the TÜV. We've been in correspondence with Heinrich Gillet Company one of the German manufacturers who makes mufflers for various vehicles. They sent us a lot of information and data on these two Institutes that do testing for the respective governments.

I believe they're not government institutes or testing agencies but they are certified by the governments in each one of the countries. They do have a scheme and a process whereby if a company wants to sell an aftermarket muffler, in either country he must submit that product

to the appropriate testing Institute and that testing Institute uses a standard bench test methodology to evaluate the mufflers. The test is an A, B type comparison in which they compare the OEM muffler to the replacement muffler as part of the methodology. We haven't interpreted the articles fully yet, since we haven't had them fully translated. We just have selected paragraphs that have been translated. There is an indication that they use a standard engine as part of the test methodology. We will follow up on this information after this symposium.

Cecil Sparks

But they're not taking that to predict noise level on any arbitrary configuration that you have in mind thereafter. So I agree, that's a reasonable approach. To qualify your muffler.

Ernie Oddo

Well, that's what we have to find out, what qualify means. We don't have the articles fully translated but if any of the panel members are familiar with those testing methodologies and what they mean we'd really appreciate hearing.

Prof. Davies

I don't know about these two but in England it's the Motor Industries Research Assoc. and they do perform this function. And I can state quite categorically they don't use a standard engine because I know it doesn't work. They are certifying a product or a range of products for a specific vehicle and that's the way they work. They provide the certificate. I think also that from what I've heard in this meeting, from all the manufacturers including the replacement manufacturers, they do provide some sort of certificate. And I think we're getting hung up on technology. Can I get back to what I said in the beginning, if you go to buy a washer or cooker or whatever that's certified when you buy it. If you're going to buy a recreational device like a high-fi system that's really certified, I really can't understand what they put on the documentation but that's certified all right. The manufacturer puts so much dope there, if he didn't

comply you'd get him. You know for non-compliance, at least he's responsible. Well, there's one point. After and secondly you go and buy whatever junk you like and put it in your house but if that doesn't meet city regulations that's your responsibility and it's not the supplier's fault. So I'm saying, the route to follow is the supplier, provides the certificate, and I think they're willing to do this, and the user is responsible to seeing the compliance is agreeable. Now, if the user's worried it's up to him to approach the supplier and say, look, if I use that product am I going to get bombed. And he'll get an answer.

Peter Cheng

I would like to agree with Professor Davies and I would like to amplify that point showing our extremes. In the State of Florida our aftermarket customers would like to buy high performance mufflers more so than many other states for the simple fact the State of Florida has a rather strict enforcement.

Larry Eriksson

You mentioned other products and I think it's probably obvious but I think you should say for the record that there are a couple of other things on these other products that are extremely important to consider, the obvious one, particularly for motorcycles and snowmobiles is the extremely strong connection between the sound level of the exhaust system and the horsepower. Certainly the exhaust system is connected with the power produced by the engine for all of these products but snowmobiles and motorcycles is of such a different order of magnitude consideration in my mind that that truly has to be considered separately. The other one would be in the automobile area although we're not involved in automobile mufflers it's certainly the case that as I've been told by my friends in the industry there that subjective considerations, and I think we're all aware of this in terms of automobile mufflers, are at least as important as objective measurements and I think that's fairly unique to automobiles and perhaps it does carry over to some of the others but particularly so in automobiles that

in terms of what's good or bad for the consumer a subjective characterization does play a pretty important role in terms of whether the consumer finds this to be a satisfactory muffler and I assume this is the kind of thing we're shooting at in terms of regulatory activities as to somehow satisfy the consumer in terms of what he buys. So I think the subjective aspect is going to have to be looked at if you're out to do that for cars.

Ernie Oddo

At this point I believe we'll open up questions from the floor.

Don Whitney

I think I'd like to bring up a point that I don't think anybody at this conference has said. Namely, that we already have labels on our mufflers. We all have part numbers on them, those part numbers refer back to catalogs, those catalogs go to the individual manufacturers, the muffler manufacturers already know the performance of those mufflers in relation to the performance of other mufflers that they themselves have and they have a pretty darn good idea of what those mufflers do already. I would like to add one other part with respect to the SAE test, as I understand it in terms of an insertion loss test I really don't agree particularly that insertion loss is the thing that we want to measure. However, in terms of comparison of one muffler with respect to another, I think it can do a pretty good job of telling us equivalence on a system that truly duplicates whatever the vehicle with its exhaust pipe lengths, tail pipe lengths, etc. do manage to do. I think that we can ask a question here relative to the accuracy point that's come up many times and I would like to turn the question around instead of saying how good is the accuracy I'm more concerned with how bad is the accuracy from the standpoint that it's fine to say that a muffler is approximately equivalent to the muffler that might have been on the equipment in the first place but I worry when we say it's approximately equivalent. Is that accuracy good, do I have to put in a standard deviation of 2 dB and then in order to manufacture a replacement muffler and satisfy myself with some reasonable confidence that my new muffler will be below or equivalent to, do I have to design the new one to 5 dB below, or whatever. How bad is

the correlation is of more concern than how good is the correlation. I'd like to reiterate again it's been mentioned several times that the performance of a muffler on a particular engine does in fact affect the power but I'd like to also say that it does affect emissions also since the pressure pulse is back on the engine will affect the instantaneous pressure at the valves, etc. and as a result will affect the emission characteristics. We're getting into a dual regulatory situation where we've got a lot more than just sound levels to consider. I think that's an extremely important thing. Just the fact of possibly putting double testing in terms of requiring an original manufacturer for the full vehicle which is what I'm involved in, a double test, I would say that whenever double testing is involved it ineffectively decreases the level to which we have to manufacture trucks. Using trucks as an example simply because you have to meet both standards therefore the total truck noise is lower. That might be a desirable objective but I don't think that's the way to go about it. I would like to say that while I don't necessarily endorse the precise California procedure the J1169 SAE procedure for passenger cars is a coarse filter, it's difficult to get down to precise levels in terms of enforcement, however, it can do a job, it can do a real job more than I think new truck or new passenger car regulations will do, in the sense that those vehicles aren't really bad right now the ones that are really causing the problem in the community are the ones that don't have any mufflers, they have straight pipes, they have modified systems, that type of thing is the thing that we really need to get rid of and while the J1169 for passenger cars is a coarse affair and we all agree it's coarse it's not a fine test it can do a very effective job.

Nick Miller

I think we need to focus on the fact that as it's been mentioned, there are two areas here of concern, I think, first those pieces of equipment that are now subject to regulation as new equipment and those that aren't. We're more familiar with those that are, so we'll address those.

I think we need to remember that during the promulgation of the truck regulation and all of the other new vehicle regulations both EPA and the Industry were extremely careful to avoid any restrictions upon the componentry that's used to meet the standards. The truck regulation and the other regulations are overall performance standards and this was the philosophy taken so that each manufacturer based on his understanding of his market, could comply with those regulations most economically. Now, the concept of labeling a component is somewhat akin to wearing suspenders with a belt. The vehicle regulation, the truck regulations, and the others that are patterned after that, has tampering provisions which obligate the user to use equipment that will not degrade his noise level. In addition, the proposed revisions to in-use regulations will also provide some assurance that won't get out of hand. I think what was going to happen is that obviously the manufacturers are not going to provide equipment that will raise noise levels and the aftermarket suppliers are going to be forced into that position just to stay in business. I think this is a situation where we can depend on the free enterprise system and along with the in-use regulations to provide all the necessary policing that we need. So, I think we have to look at the objectives that we had when we first started looking at regulations for new products and stick with that philosophy because I think it is a well formed one and I think it's been fairly successful.

Ross Little

I have a comment more than a question. In sitting through this whole program, many of the speakers appear to me really aren't addressing what we need or what's needed out in the field. We need as I see it, to identify the aftermarket exhaust system which when installed degrades the noise level of the vehicle. We don't have problems as a general rule, with new vehicles. So in the rating system we need a relative noise level which correlates to a sound level ascribed

to the vehicle when the vehicle is first delivered to the first user. That can be the same test procedure or some other way of arriving at it. Then these are the main things, there is a standard being proposed here for labeling but someone eventually has to enforce it and if the numbers aren't correlatable or something that can be used, then the enforcement goes down the drain, and there is no enforcement and the whole program is lost.

Wayne Marcus - Motorcycle Industry Council

First off, in the regulations that are under consideration now labeling regulations are naturally directly from the noise control act and I'll read you one relative clause from that. Section 8, which says, "the administrator shall by regulation require that notice be given to the perspective user of the effectiveness, of the products effectiveness in reducing noise." So this is what at least the Congress and the President of the United States were looking for when this act was passed. Now, in determining what the effectiveness in reducing noise is, in my mind, we're looking not for a comparative number relative to an OEM number. What we want is to know what is the reduction in noise from a muffler, any muffler because certainly the OEM produces replacement mufflers as well as aftermarket companies. Secondly, earlier in the program today we learned that even OEM produced composite or universal mufflers for older vehicles. The replacement muffler industry including OEM replacement mufflers, is as far as motorcycles industry is concerned, is from a labeling standpoint, this labeling regulation 204, should be aimed at pre-effective date motorcycles, that is, motorcycles which are produced prior to the effective date of the upcoming new motorcycle and replacement exhaust regulations because I don't know if you're familiar with it, if all of you are familiar with it, but as far as motorcycles are concerned there are two such regulations which include labeling provisions and which include noise provisions. The ones that are coming up, very shortly will set noise level standards for motorcycles such as other types of vehicles already have on the books. This one, that we're considering here is purely for the consumer's information. Therefore, motorcycles which are produced after the

effective date of this, soon-to-be-announced noise reduction regulation, will be controlled. They will be controlled to a certain level of noise emissions. It's the pre-effective date, the ones that are out on the streets right now, those that have deteriorating mufflers on them at present and those which have engines which have gone through an extensive break-in period and have different source characteristics than when they were originally produced. So what I'm interested in is knowing how to look into and how to discover what the reduction characteristics of an exhaust system are on these broken-in, presently-on-the-street vehicles, not necessarily the vehicles that are going to be regulated.

Martin Burke - John Deere

I have both questions of the panel as well as comments. In the area of snowmobiles, snowmobiles have been regulated by States for a number of years now, have a 78 dBA drive-by level per SAE J192.

As a result of this fairly stringent regulation snowmobile manufacturers have had to put in unitized exhaust systems on the column in which there is only a single connection between the engine and the exhaust system that is a single flexible type connection. Earlier years we used to see systems that had two or three joints in it and which you could perhaps replace with various components. Since snowmobiles are basically different between manufacturers, I guess I'm not currently aware of an outside replacement market on snowmobiles other than the OEM supplying exact replacement parts. Which would I guess in the case of our company, be identical to or better than the original ones, and I say better than, it could be a case where we carried a model through several years and because of the increase or reduction of noise we've had to improve the exhaust system in those cases we have replaced the older systems for repairs with the newer systems. How what decision does a customer have to make if he can only get one system from one source for that machine.

Unknown

I'd like to clarify one point, and that is that it's impractical to put a noise level on an exhaust system. Where vehicles that are manufactured to meet an overall vehicle regulation one manufacturer may require more of the exhaust system than another does. And so the only thing that makes any sense is to require equivalence to the original system. And that's much easier to get than a number to begin with and it's the only one that's going to make any sense to the consumer.

Frank Savage - Donaldson

I look at this thing and there are three parts to this whole question here. One is the government which is responsible for setting the standards and enforcing the standards and the manufacturer who makes the particular product and has to and must stand behind that product as far as performance is concerned. And then the consumer, and it seems like what we're doing here is putting the entire load or the responsibility for meeting noise regulations on the manufacturer or the government. I think the consumer has an equal share in this whole business here. I think that the muffler manufacturers can provide a bench mark and I say bench mark because that eliminates the accuracy type of question but at least it's a bench mark which he will certify, that says that this product will work on these machines. You've got to make sure that the consumer has not taken this good quality muffler off and replaced it with a tin can or a straight pipe. You've defeated the purpose of course, of the silencer supplier or the program or in the case of the heavy truck user, where the shell is still in good condition but all of the internal parts are ignored, but you still run it down the road. The second test that has been used widely is the total vehicle noise test. Now, I'm not suggesting that all these tests be run simultaneously by any one person but the total vehicle noise test allows the final supplier of either the whole snowmobile or the whole truck or the whole motorboat, integrate all its noise sources to qualify through some procedure in his own facility. I think it's been demonstrated a number of times that if you want to get a sound

pressure level at some distance in trying to use a bench type test, that you have to use the actual engine with the actual system or a system that is qualified to predict some sound pressure level at some distances. There were at least two procedures given today by Larry Peters, by a John Deere man where they had correlation with their own bench testing to get them to fifty feet. Of course, these facilities individually could be certified by EPA and then with published sound levels a certificate could go out that certifies that the silencer was tested in a facility certified by EPA. We already have a mechanism that takes care of not relating accurate information and that's called a guarantee. A man simply has to ask for a guarantee and if it doesn't meet it let's say a truck muffler, if he buys one and takes it out to Mr. Ross's test station and it doesn't pass the test he carries it back and gets his money back. So, that allows all the test facilities to date to go ahead and operate. We have dealt with the problem of muffler labeling only in ISMA, Industrial Silencer Manufacturing Association, we have to deal with that because of the stationary source, seldom do you know what the exhaust pipe length is or what the tail pipe length is and in many cases the silencer is purchased and you really don't know what the engine is. From my own experience, and I'm going to go back to some of the things that Larry indicated and Mr. Blaser from General Motors, if you want to talk apples to apples, a simple comparison of mufflers, not relating it the in-use sound pressure levels, because you cannot unless it's on the actual engine on the same source but if you want something like the absorption coefficient, or transmission loss class, what is it? - ASTM70 they give a laboratory test procedure and clearly state that you'll get different numbers when you apply this to the field. If you have to have some comparison, then you need to look at broad-band noise. I prefer insertion loss with no tail pipe and then an exhaust system, exhaust pipe that minimizes the effect on any silencer that would be tested. And it would have to be tested at an average flow rate for the mean end use, i.e. automobile exhaust typically has much higher exhaust velocities than in the stationary engine and it would have to be tested at some average or mean temperature for the end use, this is particularly true for an engine exhaust versus an engine intake.

Ken

I'd like to make a comment on these procedures that, if they don't include shell noise or pipe noise or leaks due to clamps or anything like that, they aren't going to be accurate and we have to ask EPA what accuracy we're looking for.

Ernie Oddo

Thank you. This is the last call for questions for the panel while we have them up here. He will next go into the third part of our program in which the EPA members will replace the panel members on stage and we will open the session with questions from the floor.

Panel members, we thank you very much for your participation in this symposium.

A reminder to everyone that we will be publishing proceedings of this symposium in the very near future. Everyone who attended this symposium certainly will receive a copy of the proceedings. A word to those people who gave papers at the symposium, please send copies of your paper, with art work to me at McDonnell Douglas in California. We are assembling the proceedings for the EPA.

At this time, we will open this session for questions for the EPA from the audience.

Bill Roper

Perhaps I should pick up on some of the questions that were asked earlier. The one from Larry Erickson about what is the objective of the EPA labeling program? I think that at least the general objective remains the same as it was spelled out in the Federal Register notice, the four points that we've put on the board, or the viewgraph a little earlier, but I think specifically relating to exhaust systems, there's

two specific areas where we were looking for information at this meeting and that was information on development of a statistic for a comparison between two exhaust system or two mufflers; an A-B comparison with OEM or whatever, a relative comparison between two systems. The other is a statistic or approach for developing information, statistic information, on comparison between a total vehicle level and the exhaust system. Now those are two general categories of information that involve different methodologies and can be used in different ways. And we've had opinions expressed as which one is the better or the worse. I think to be quite frank, in a government study effort such as we have under way here that we may or may not lead to any type of regulation, whether it be labeling or eventually a standard, a noise performance standard, it would be in a sense dishonest on my part to say specifically what is going to happen or what's not going to happen. We're collecting information at this point, to define what the problem is and what the possible solutions are given the general objective providing information to the consumer or user, in this case, exhaust system muffler, that he can use in the purchase decision. I don't know if that's a satisfactory answer Larry, but that's what I have to give you. Another point that was raised by Nick Miller regarding the situation in the truck area. Implying that there really wasn't a need for this kind of information to be conveyed to the user, or purchaser of a muffler, I think he has raised some good points; that is a good point in the truck area.

I would limit it to that portion of the truck industry that involves vehicles that are operated by interstate carriers. I think that's fairly valid because in that area EPA does have the authority to set in-use standards. There's only two areas where EPA has that authority and that's for interstate motor carriers, or vehicles operated by interstate motor carriers, and for interstate equipment and facilities operated by interstate rail carriers, Section 17 and 18 in the Noise Control Act. So in those two areas and the railroad area we have not set Section 6 new product standards that apply to those vehicles when they are newly manufactured. We also have authority in the in-use area and we have such standards. So there is a follow-through so-to-speak on total vehicle, at least compliance requirements. Out of course

that would not hold true in every other product category that was listed in the matrix. But again, I think I would go back and say that it still remains important for the user to have the information available to him that the muffler or the exhaust system that he's applying to his truck will allow the total vehicle to meet a particular sound level and quite frankly in looking at some of the material that has been presented by Donaldson for example, where they I think, to a large degree, are providing their customers with that type of information. Now, one of the principal objectives of the EPA is the encouragement of voluntary labeling which would describe the acoustical performance of a product. Now we're encouraging that and if that occurs without any Federal involvement, which is one of our other objectives that I mentioned, minimal Federal involvement, I think that's what we're after, which is a reduction in noise and if it can come about with voluntary programs, that's fine. So, I've attempted to respond I guess to some of your comments Nick and I think maybe this helps clarify for the others some of the ramifications that are applicable on trucks but not perhaps in other areas. With that I guess I'd open this session with a call for questions from the floor.

Ed Halter - Burgess

You do have promulgated regulations, proposed regulations for air compressors, that give a dB level that you have to check at four or five points around the compressor and that is an overall level including a prime mover which could be an engine, which undoubtedly would have some kind of a muffler on it. And you've also required the manufacturer of the air compressor to warranty it for the life of the unit, a service life be it four years, that the system would, noise wise, maintain that level. It's required when it's manufactured. I would assume then that the manufacturer is going to, if necessary replace those acoustic components with equivalent acoustic components of the same, I guess the same manufacturer, right? He would have to if he installed these OEM parts and he's warranted this, if they had any problems or the customer ran a truck or damaged one of these components they have to be replaced with the same item that was originally manufactured. Is that correct?

Bill Roper

It would have to be replaced with a comparable system component. Let me go back a minute now. On the portable air compressor, when that standard was promulgated it didn't include as I recall, what we call the acoustical assurance period of some period of time when that product would be required to continue to emit or meet the standard at which it was designed to meet the standard at the date of manufacture. In the later regulations that we recently imposed on wheel and crawler tractors that the acoustical assurance period concept was involved. But essentially, the maintenance instructions that are incorporated in the standards require that the manufacturer identify those components of the piece of equipment that are key noise control components that if something happens to one of those components unless it's replaced with an equivalent system it would not meet the standards. Essentially identifying to the user, hey look, here's a list of things you better keep track of and maintain properly or you're not going to meet the standard.

Ed Halter - Burgess

Isn't this essentially what you're addressing here with respect to ground transportation. In other words, if you had a muffler as part of a package and you have to replace that muffler with the same type muffler, right? The easiest way to do that is replace it with the same item, the same part number, the same manufacturer, you may have to qualify other suppliers if you have a monopoly problem to produce that same product.

Bill Roper

I think from our perspective we get into our general counsel informs us, a constraint of trade situation, if we specify that it must be OEM replacement. So we're looking at ways of identifying the performance so that anyone who produces a product that meets that performance could in fact sell it, have it applied to the piece of equipment and if that gets back to what we're talking about today, and that way can be used to characterize the performance, in this case of the exhaust system.

Ed Halter - Burgess

But wouldn't the ultimate be that you had to qualify that on that particular piece of equipment. In other words, if you're going to replace this on a crawler tractor and you had a certain procedure to checkout on a crawler tractor, you would then, any of the replacement mufflers or components would be tested on the crawler tractor and that same method.

Bill Roper

That's certainly one way it could be done. Probably the easiest way it could be done at this time.

Ernie Oddo

Another thing I'd like to add here. Concerning exact replacements to the OEM, we've met with the automobile manufacturers and other motor vehicle manufacturers and have discussed consolidation of design. A wide variation of many different designs result from continued consolidation. The end result is a raft of mufflers that are still so-called OEM equipment. You may find a wide tolerance there if you would actually measure the performance of those aftermarket mufflers and compare them with the OEM performance. There could be 3, 4 maybe 5 dB difference. That's the practical world.

Doug McBann - Ford Motor Co.

I'd like to clarify the statement that Ernie just made. From a regulatory standpoint the aftermarket mufflers that we produce and sell are equivalent to original equipment. The subjective levels have been compromised in many cases.

Bill Roper

Could I ask a question? It came up in the earlier session that in the automotive area, looking at subjective levels was important. Is that in regard to exterior, interior or both?

Doug McBann - Ford Motor Co.

Both.

Jim Moore - John Deere

The snowmobile industry currently has a voluntary total vehicle noise labeling program and Martin Burke brought out the fact that there currently exists no aftermarket in snowmobile exhaust systems. In view of this, do you think it's necessary to label snowmobile exhaust systems?

Bill Roper

I think the information we have been provided on snowmobiles certainly puts them in a unique situation. I think, compared with some of these other areas and that's certainly something we'll consider. Whether there is a need or not in the snowmobile area. Again, I think I want to go back to the point that we're really on a fact-finding mission at this point in this particular area of exhaust emission performance and this kind of information is very useful to us. I can't sit here and say what the agency is going to decide to do on that particular question because I don't know, but certainly that information would raise a question of whether or not it's necessary on snowmobiles.

Doug Rowley - Donaldson

I'd like to discuss this voluntary action a little bit Bill. I know that Ross Little spent about a year and a half getting voluntary action out in the State of California relative to controlling truck noise and I'd like to ask the EPA the question, how you intend to get voluntary action? Obviously, it must be through some enforcement program. Could you touch on that a bit?

Bill Roper

In response to that I think again of the EPA's standpoint we would be looking at what's happening out in the country now. For example, is there an effective voluntary compliance program now? As a result of say State regulations. An awareness on the part of the manufacturer that his product is noisy and is adversely affecting his sales and causing him a harrassing problem because it's against state regulations or whatever and that the industry say has gotten together and come up with a test procedure and is voluntarily certifying or labeling or whatever their product to meet a specific noise level. We would be looking at what's happening today, and how that relates to reducing noise from that particular product. I might go on further and site some examples. In the snowmobile area which was mentioned earlier today, there was a lot of concern in various snowbelt states for levels from snowmobiles and there were laws passed and then there was response by the snowmobile industry to do something about lowering their noise levels. They did establish or agree amongst the association a procedure that was acceptable to them to identify the noise performance of their product and they have gone ahead and labeled. That's just one example, there's perhaps others but from EPA's standpoint, I think as we move into any area where there was labeling or setting standards we would be assessing and looking at what's being done now with that product and what's possible to be done. Again, I guess we are going to a Section 6 regulatory study which many of you may be aware, the kind of three pronged approach we take there and that is to look at what technology is available, what's the cost of applying that technology and what kinds of health and welfare benefits you get from applying the various levels of technology. We in the standards and regulations division are responsible for putting together the facts and coming up with recommendations for the agency to make decisions on and so again, our job is fact finding and certainly what's going on in the industry as far as voluntary standards is an important factor that would go into the arraying of information and generation of recommendations.

Ernie Oddo

We have time for one or two more questions.

Ross Little - CHP

I have a comment on snowmobiles - To begin with, I don't know anything about snowmobiles. We regulate them but we don't have many out in California, fortunately. But I am hard pressed to believe that they're as innocent and pure as they are making out to be, I beg your pardon, but I know they race snowmobiles and if Hooker Industries think they can get another ounce of horsepower out of the snowmobile with an unsilenced expansion chamber, that's what you're going to find on it. And if they'll race with them, they'll also ride out in the woods with them. They do motorcycles.

Bill Roper

That's the other side of the coin. We're looking and we're sensitive to that side also. Although there appears to be some difference between the snowmobile user as a general group and motorcycle users as a general group based on the information we've seen so far.

Jim Moore

Just a slight rebuttal to what the gentlemen is saying. It is certainly true, there are expansion chambers and stuff available but I don't call those silenced exhaust systems, and in most states they are not allowed to run except on the race track in a sanctioned race and in today's racing rules, generally you could determine whether you're going to race stock or race modified. If you race stock you're going to have to have a system that meets the 78 dBA level. If you race modified, and they are allowed in some areas, the manufacturer has no control of that and nobody gives a dang about the sound level on those machines, especially the guy racing or the people at the race track.

Ernie Oddo

One last question.

Nick Miller - International Harvester

I think the point here is that whether the parts are labeled or whether they're not labeled, has nothing to do with whether someone will modify a vehicle no matter what it is. I think it's important as we address the EPA's concern for voluntary program. Could we have the matrix back up on the board for just a second.

I think it's important to bring up at this point the areas where we do have voluntary areas that have been successful. First of all, both the auto and light trucks have been very successfully controlled in California and some other localities on a voluntary basis by the manufacturers. It's not new vehicles and well maintained vehicles in any of those areas that are a problem, it's modified vehicles and only enforcement will solve that problem. The heavy truck you alluded to Bill is a matter there of the ICC regulation, motorcycles are just about to be regulated and in the hearings that I've attended in the various states and so on they have done a good job of bringing their vehicles and aftermarket parts into compliance where they are regulated. Snowmobiles we have noticed, have a special situation as you said, buses you now have your thumb on and so I guess all I can see that's there any major gain for is motorboats and I understand you're looking at those, Bill

Bill Roper

We just started this year looking at those. I might respond a little more to Nick's comment there. I'd add though, that in the early stages on all of those products that we have regulatory programs fairly downstream or have already set regulations that we did look at what was going on from a voluntary standpoint in the early stages of the study and I'd like to mention that in California and some

of these other places, automobiles and light trucks, they did have standards in effect in the late sixties or earlier seventies that set standards in a sense did have a lot to do in bringing some of the noise levels down. I also agree that it's the modified vehicles that are a problem. That varies from category of vehicle to other categories of vehicles on how big a problem it is. Particularly motorcycles seems to be a big problem.

Wayne Marcus, - HIC

I'd like a clarification, I got the impression from listening to you earlier that you're shooting for some form of comparative rating as opposed to an absolute rating. I'm speaking of comparing the level of an aftermarket exhaust system to an OEM exhaust system or comparing an exhaust system to a total vehicle noise. Is this a misconception, if not can you explain why you're shooting for comparative?

Bill Roper

I meant to convey the thought that we're looking at both of those. We have not decided at this point whether one from our standpoint is better than the other, but we did want to get comment and information on the kinds of things that would be available to us as tools in assessing the performance of an exhaust system by both approaches. Does that answer your question?

Wayne Marcus

Yes

Ernie Oddo

Thank you very much. Is there a final comment you would like to make, Bill, before we close the session?

Bill Roper

I guess from EPA's standpoint I would like to again thank all of you for participating in this symposium. This is, I think the first time the EPA in the noise office has conducted this type of meeting with the technical experts in an area this early in a study program and as I think has been shown, in this afternoon's session there really are no easy answers to some of the questions that we're faced with attempting to collect information on and make recommendations to the agency. There is difference of opinion and we're not surprised by that, but I think it's been very constructive the last three days to have the caliber of people that we've had at this meeting together in discussing, I think quite frankly and openly, their opinions on this subject and I heard a comment earlier this morning that even if there were no specific recommendations that came out of this meeting, but just the fact that a lot of ideas were thrown up, a lot of thoughts have been discussed that some of the manufacturers of these products may have picked up some ideas and we may get potentially some noise quieting coming out of the ideas that were exchanged at this meeting. After all, that's the business that we're really in is to make it a little quieter out there in the environment and I think that's great if we contributed toward doing that through this meeting; so again I'd like to thank you all and wish you a safe journey home with one thought too that I want to leave, and that is that this is in a sense the beginning of what I hope will be a continuing dialog between many of you and EPA as we move further along in this program, so thank you.

LIST OF ATTENDEES

ALFREDSON, R. J. DR.
Monash University, Dept. of Mechanical Eng., Clayton Victoria,
Australia 3168

ARBIZZANI, RON, Dir. Muff. Eng.
Maremont Corp., 250 E. Kehoe Blvd., Carol Stream, Ill. 60187

BASCOM ROGER, Chief Engineer
Harley-Davidson, 3700 W. Juneau, Milwaukee, Wisc. 53201

BAXA, DONALD E., Prof.
University of Wisconsin, 432 N. Lake St., Madison, Wisc. 53706

BECK, JIM, Manager
Sun Electric, 6323 N. Avondale, Chicago, Ill. 60631

BECKON, WEIR, Manager Sales
Donaldson Co., 1400 W. 94 St., Bloomington, Minnesota 55431

BELLINO, ROCKY, R&D Manager
Mr. Gasket Co., Div. W.R. Grace, 4566 Spring Rd., Cleveland, Ohio 44131

BERIL, MARTIN, Manager Acc. Prod.
John Deere, 220 E. Lake St., Horicon, Wisc. 53032

BLASER, DWIGHT A., Sr. Research Engineer
GM Research Labs, GM Technical Center, Warren, MI 48090

BLASS, JAROSLAV, Res. Mgr.
Kawasaki Motor Corp., Shakopee, Minn

BORTHWICK, JESSE O., Noise Section Administrator
F1 Dept. of Envir. Regulation, 2562 Executive Center Circle E.,
Tallahassee, FL 32301

BOTELER, KEN, V.P.
D&N Mufflers, 2415 S.W. 14th, Oklahoma City, Oklahoma

BRANMER, A. J., Dr.
National Research Council of Canada, Montreal Road, Ottawa, Ont. KIA0S1

BRENNAN, KENNETH, Engr.
Hendrickson Mfg., 8001 W. 47th St., Lyons, Ill. 60534

BURKE, MARTIN
John Deere, 220 E. Lake St., Horicon, Wisc. 53032

CAMILL, JOHN, Sales Manager
Stemco Mfg. Co., P.O. Box 1989, Longview, Texas 75601

CHENG, PETER, Sr. Engineer
Stemco, #9 Industrial Blvd., Longview, Texas 75601

CRAGGS, TONY, Dr.
University of Alberta, Edmonton, Alberta, Canada T6G 2E1

CROCKER, M. J., Dr.
Purdue University, Ray W. Herrick Labs, W. Lafayette, Indiana 47907

DANNER, T. A., V.P. Engineering
Arvin Auto Div., Arvin Ind., Columbus, Indiana 47201

DAVIES, PETER, Prof.
I.S.V.R., University of Southampton, Southampton, England SO95III

DIKA, ROBERT, Noise Engineer
Chrysler Corp., Proving Ground, Chelsea, MI

EARNSHAW, GINNY, Editor
Bureau of National Affairs, 1231 25th St., Washington, D.C. 20037

EDWARDS, SCOTT
EPA, Crystall Hall, #2, Room 1102, Mail Code AH-471,
Arlington, VA 20460

ERICKSON, LARRY, V.P.
Nelson Industries, P.O. Box 428, Stoughton, Wisc. 53589

GIRVAN, MICHAEL J., Asst. Exec. Dir.
Motorcycle & Moped Ind. Council, 802-45 Richmond St., W. Toronto,
Ontario Canada M5H 1Z2

GOPLEN, GARY, Devel. Engr.
Nelson Muffler, Box 420, Stoughton, Wisc. 53509

GROCK, RAY, President
Pipes Etc., 1632 W. 139th, Gardena, Calif.

HALL, JAMES R., V.P.
A P Parts Co., 1801 Spielbush Ave., Toledo, Ohio 43694

HAAS, THOMAS G, Noise Control Engr.
J.I. Case Co., 700 State St. CL 124, Racine, Wisc. 53404

HARTER, E. J., Chief R&D Engr.
Burgess Industries, Burgess Manning Div., 3101 Carpenter Fwy.,
Dallas, Texas 75247

HENDRIX, DAVID, R., Manager C. Engr.
Riley-Beaird Inc., P.O. Box 31115, Shreveport, LA 71130

HERBERT, MARK
University of Cincinnati, Mech. Eng., Mail Loc #72, Cincinnati,
Ohio 45221

HICKLING, ROBERT
General Motors Research, Warren, MI 48070

HORNETT, HARRY, Senior Engr.
McDonnell Douglas Astr. Co., 5301 Bolsa Ave., Huntington Beach, CA 92647

INAGAWA, MINEICHI
Mitsubishi Motors Co., 10-Onkuracho, Nakaharaku, Kawasaki, Japan

IRVINE, GERALD, Mgr. Engr.
Scorpion Inc., P.O. Box 300, Crosby Hill, 56441

JOHNSON, DUANE, Test Engr.
Caterpillar Tractor Co., 100 H.E. Adams, Peoria, ILL 61601

KERR, JAMES
USCPA, Washington, D.C. 20460

KICINSKI, KEN, Engr.
Helson Muffler, Rt. 51, Stoughton, Wisc., 53589

KILNER, ROGER D., Mech. Engr.
National Bureau of Standards, Bldg. 233, Room A149,
Washington, D.C. 20234

KONISHI, K., Director, Washington Office
JAWA 1050 17th St., N.W., Washington, D.C. 20036

KOPEC, JOHN, Acoustical Liaison Engr.
Riverbank Acoustical Labs, 1512 Batavia Ave., Geneva, ILL. 60134

KRALL, ERIC G.
A B Volvo Truck Div., Dept. 26435, A.D. 29, Gothenburg, Sweden

LAI, PATRICK K.
A.C.S. Ltd., 114 Rainside Road, Toronto, Ontario, Canada

LITTLE, ROSS A., Engr.
Calif. Highway Patrol, 255 1st Avenue., Sacramento, CA 95808

LOTZ, R. W.
Chrysler Corp., Detroit, Michigan

MC CORMICK, JAMES, St. Engr.
Walker Mfg. Co., 3901 Millis Rd., Grass Lake, Mich 49240

MC DONAGH, JAMES R.
Riker Mfg. Inc., 4901 Stickney Ave., Toledo, OH 43612

MANN, ROY L., Engr.
J.I. Case, 700 State St., Racine, Wisc. 53404

MARCUS, WAYNE, Technical Analyst
Motorcycle Industry Council, 4100 Birch St., Suite 101
Newport Beach, CA 92660

MARGOLIS, DONALD, Prof.
University of California, Dept. of M.E., Davis, CA 95616

MASON, BOB
US DOT/Transportation Systems Center, Kendall Sq., Cambridge MA 02142

MILOS, JOSEPH, Q.C. Manager
H.D.I., 5310 W. 66th St., Chicago, Ill.

MILLER, H.A., Staff Engr.
International Harvester, 2911 Meyer Road, Ft. Wayne, Ind. 46803

MOLLOY, CHARLES T., Dr.
USEPA, Washington, D.C.

MONDZYK, DARRYL J.
Muffler Dynamics Inc., 5310 W. 66th St., Chicago, Ill., 60638

MOON, CHAS. L., Mgr Test
White Motor Corp., 35129 Curtis Blvd., Eastlake, Ohio 44094

MOORE, JIM, Engr
John Deere Co., Horicon, Wisc. 53032

MORLEY, R. K., Supv.
Ford Motor Co., 21500 Oakwood, Dearborn, Mich 48124

MORSE, IVAN E., Prof.
University of Cincinnati, Mail Loc 72, Cincinnati, Ohio 45221

MUTH, ROY W.
International Snowmobile Industry Association, 1800 M. Street N.W.
Washington, D.C. 22036

MC BAIN, H.D., Dev. Engr.
Oakwood Blvd., Dearborn, MI 48120

NAVARRE, GEORGE, Sales Manager
Riker Hfg. Inc., 4901 Stickney, Toledo, Ohio 43612

NECHUATAL, MICHAEL
Illinois EPA, 2200 Churchill Rd., Springfield, Ill. 62706

REST AVAL ARIF NGRY

NEMECELL, JACK, Sales Mgr.
Donaldson Co., Minneapolis, Minn

NICHOLS, JEAN
Bombardier Research Center, Valcourt, Quebec, Canada

NIEMOELLER, DON, Lab Manager
Arvin Automotive, 2505 N. Salisbury St., W. Lafayette, Ind. 47906

NOLEN, ROBERT K., Manager
Haremont Corp., 250 E. Kehoe, Carol Stream, Ill. 60187

NORDIE, KENNETH D., Designer
Nelson Muffler, Box 428, Stoughton, Wisc. 53589

ODDO, ERNEST T.
McDonnell Douglas Astr., 5301 Bolsa Ave., Huntington Beach, CA 92647

OLSON, DAVID A., Sr. Research Engr.
Nelson Industries, P.O. Box 420, Stoughton, Wisc., 53589

PAGE, W.H., Res. Engr.
International Harvester, 75600 County Line Rd., Hinsdale, Ill. 60521

PALAZZOLO, JOSEPH A., Dev. Engr.
Ford Motor Co., 20500 Oakwood, Dearborn, MI 48124

PARKER, ROBERT, Ac. Engr.
A M F Harley Davidson, Milwaukee, Wisc.

PETRALATI, VIC, M.E.
USEPA, 401 M. St., S.W., Washington, D.C. 20057

PRAIDRA, NICK, ACCT. Mgr.
Donaldson, Co., Inc., P.O. Box 1299, Minneapolis, Minn 55440

REINHART, CHARLES, Test Engr.
Donaldson Co., Inc., P.O. Box 1299, Minneapolis, Minn, 55440

RENNEK, J. H.
Cipon Industries, Inc., 22 Ikon St., Keydale, Ontario

RENZ, WILLIAM, Ct. Mgr.
Nissan Motor Corp., 18501 S. Figueroa St., Carson, CA 90248

ROBERTS, PETER, MGR.
Gidon Ind., Inc., 22 Iron Street, Rexdale, Ont. MGLS 5E2

ROBLEY, ELROY, Proj. Engr.
FWD Corp., Clintonville, Wisc. 54929

ROMINGER, D., Engr.
818 Sylvan Ave., Englewood, Cliffs, N.J. 07632

ROPER, Wl. E., Chief STB
USEPA, AW471, Std. & Reg., Div., Washington, D.C. 20460

RONCI, W.L., Director Exch. Sys. Eng. & Research
Walker Mfg., 3901 Willis Road, Grass Lake, Michigan 49240

ROSA, B.A., Director Product Engr.
A P Parts Co., 543 Hatzinger Road, Toledo, Ohio 43697

ROSS, DAVID, Res. Engr.
Arvin Ind., 2505 N. Salisbury, W. Lafayette, Ind. 47906

ROWLEY, DOUG, Ch. Engr.
Donaldson Co., Inc., 1400 W. 94th St., Minneapolis, Minn.

SCHMIDT, WAYNE, A., Mgr
Haremont Corp. 250 E. Kehoe Ave., Carol Stream, Illinois 60187

SCHNEICHER, STEVE, Pr. Engr.
Donaldson Co., Inc., 1400 West 94th St., Minneapolis, Minn.

SCHULTZ, DOUG, VP Engr.
Walker Mfg. Co., 1201 Mich. Blvd., Racine, Wisc. 53402

SEYBERT, ANDREW, F., Asst. Prof:
University of Kentucky, Lexington, KY 40506

SHAFFER, FRED, Proj. Engr.
The Flexible Co., 970 Pittsburgh Drive, Delaware, Ohio 43015

SHAUGHNESSY, JIM, Supv. Exh. Engr.
Hayes Albion Corp., 1999 Wildwood Ave., Jackson, Mich 49202

SMITH, MI. A., Prof.
University South Florida, College of Engineering, Tampa, FL 33620

SNECKENBERGER, JOHN E., Assoc. Prof.
West Virginia University, Mechanical Engineering, Morgantown, W.V. 26505

SHIDARICH, FRANK, Mgr.
Donaldson Co., Inc., 1400 W. 94th St., Bloomington, Minn 55431

SPARKS, CECIL R., Director
Southwest Research Inst., P.O. Drawer 28510, San Antonio, Texas 78284

STEPHENSON, DONALD, Sen. Research Engr.
Outboard Marine, P.O. Box 663, Milwaukee, Wisc. 53201

STOCK, ARTHUR W., Chief Engr.
Crown Coach Corp., 2428 E. 12th St., Los Angeles, CA 90646

STURTEVANT, B. Prof.
Caltech, Pasadena, CA 91125

SVOBODA, ED, VP Engr
Hidas International Corp., 5300 W. 73rd St., Bedford Park, Ill 60638

THOMAS, J. W., Vice Pres.
Haremont Corp., 250 E. Kehoe Blvd., Carol Stream, Ill. 60187

VAN DEMARK, RALPH, Ext. Dir.
A.E.S.H.C., 222 Cedar Lane, Teaneck, N.J. 07665

WHITNEY, DON R., Exec. Engr.
General Motors, G.M. Tech Center, Warren, Mich 48090

WRIGHT, PETER, Pres.
Gidon Ind., Inc., 22 Iron Street, Rexdale, Ontario

YAMADA, MAKOTO, Staff Eng.
Toyota Motor Co., 1099 Wall Street West, Lyndhurst, N.J. 07071

United States
Environmental Protection
Agency

Official Business
Penalty for Private Use
\$300

Fourth Class Mail
Postage and Fees Paid
EPA
Permit No. G-30

Washington DC 20460
AW-490

BEST AVAILABLE COPY