



*N-96-01*  
EPA-ONAC LIBRARY COPY..

550/9-74-012

*II-A-20*

# **NOISE IN RAIL TRANSIT CARS: INCREMENTAL COSTS OF QUIETER CARS**

**JUNE 1974**

**U.S. Environmental Protection Agency  
Washington, D.C. 20460**

Document is available to the public through the National Technical Information Service, Springfield, Virginia 22151

Document is available in limited quantities through the Environmental Protection Agency, Office of Noise Abatement and Control, Arlington, Virginia 20460

550/9-74-012

**NOISE IN RAIL TRANSIT CARS:  
INCREMENTAL COSTS OF QUIETER CARS**

**JUNE 1974**

**Prepared For:**

**U.S. Environmental Protection Agency  
Office of Noise Abatement and Control**

**Under Contract No. 68-01-1539**

This report has been approved for general availability. The contents of this report reflect the views of the contractor, who is responsible for the facts and the accuracy of the data presented herein, and do not necessarily reflect the official views or policy of EPA. This report does not constitute a standard, specification, or regulation.

## FOREWORD

The Environmental Protection Agency is publishing a series of reports prepared by contractors describing the technology, cost, and economic impact of controlling the noise emissions from commercial products. It is hoped that these reports will provide information that will be useful to organizations or groups interested in developing or implementing noise regulations. This report was prepared by Bolt, Beranek, and Newman under EPA Contract 68-01-1539.

## TABLE OF CONTENTS

	Page
INTRODUCTION .....	1
INDUSTRY OVERVIEW .....	3
Transit Systems and Car Operations .....	3
Car Builders and the Procurement Process .....	6
NOISE IN TRANSIT CARS .....	9
Where Noise Originates .....	9
How Noise Reaches Passengers .....	11
The Noise Environment in Cars .....	13
NOISE REDUCTION AND ITS COSTS .....	19
Car Design Modifications for Noise Reduction .....	19
Costs and Benefits .....	20
Incremental Costs of Quieter Cars .....	22
REFERENCES .....	R-1
APPENDIX A: IN-CAR NOISE SPECTRA .....	A-1
APPENDIX B: LIST OF TRANSIT SYSTEMS PERSONNEL .....	B-1

## LIST OF FIGURES

		page
Figure 1.	Schematic section of transit car in tunnel ..	9
2.	Schematic diagram of paths for sound transmission into car interior .....	11
3.	Steady noise levels in transit cars on tangent track of good quality above ground ..	14
4.	Steady noise levels in transit cars in subway tunnels .....	15
5.	Incremental costs of noise reduction .....	22
6.	Net discounted cost increase (for 8% annual interest rate, 25 year life) associated with noise reduction .....	26
A.1.	Noise levels in TTC car 5414 on tangent track .....	29
A.2.	Noise levels in TTC car 5414, on curve .....	30
A.3.	Noise in TTC car 5414, at 30 mph on main line .....	31
A.4.	Noise levels in CTA cars 2251, 2252 (Budd Co.) on welded and ground rail, on grade, ties on ballast .....	32
A.5.	Noise levels in several European subway cars.	33
A.6.	Noise levels in several subway cars .....	34
A.7.	Noise levels in several North American subway cars at 30 mph .....	35
A.8.	Noise levels in two transit vehicles at 40 and 45 mph.....	36

## NOISE IN RAIL TRANSIT CARS: INCREMENTAL COSTS OF QUIETER CARS

### INTRODUCTION

Literally thousands of residents of major urban areas of the United States spend major fractions of an hour of each working day riding rapid transit systems to and from work. Many rail transit systems, particularly some of the older subways, are notoriously noisy. In some of these, in fact, a passenger might be subjected to noise exposures that exceed the limits specified in the Walsh-Healy Public Contracts Act and in other occupational and safety legislation. Clearly, reduction of the noise that passengers of rapid transit systems experience deserves more than casual consideration.

The noise exposure - i.e., the auditory discomfort and/or hearing damage a person may suffer - depends not only on the intensity of the noise, but also on its duration. A very intense noise that lasts for only a second tends to contribute less to the noise exposure than a much lesser noise lasting ten minutes. Since transit passengers typically spend much more time in cars than on station platforms, it appears that the noise exposure of such passengers depends primarily on the noise environment in cars, even though the noise levels in stations may also be quite high.

It is clear that the noise within a rail transit car depends not only on the constructional and operating characteristics of the car, but also on those of the right of way. Noise reduction thus may be achieved by modifying the car or the right of way. Although right of way maintenance and modifications constitute noise reduction means that can be very effective, rights of way tend to be strictly under the purview of the transit authorities and major modifications or upgrading in maintenance tend to be

extremely costly. On the other hand, noise control measures may be implemented relatively readily and inexpensively in new transit cars, which may be designed by car builders so as to meet noise specifications. Although it is desirable to achieve significant noise reduction in cars currently in service, retrofitting is likely to be quite costly and is beyond the scope of this study. Accordingly, it is the purpose of the present report to characterize the noise climate in transit cars that are currently in operation, to describe modifications that may be included in newly-designed cars for noise reduction purposes, and to estimate the associated costs.

The information summarized in this report was gleaned from the open literature and from private reports and was derived in part from interviews with key personnel at transit systems and transit car builders.



## INDUSTRY OVERVIEW

### Transit Systems and Car Operations

There are eight major rail rapid transit systems in the continental United States. Their salient characteristics pertinent to the present discussion are summarized in Table I.

Of particular interest is the large number of operational cars and the capital investment they represent; new cars currently typically cost between \$250,000 and \$300,000. Because of this large capital cost, transit authorities tend to operate cars as long as possible, replacing cars and components only when they become totally inoperative. Although the design life of cars has been of the order of 25 years, some have been kept in service almost twice that long. Thus, there are in use today many antiquated cars, which tend to be much noisier than newer ones - particularly since the older cars are not air conditioned and run with windows open in warm weather.

Rapid transit systems tend to place all available cars into revenue service during the rush hours. Inspections and repairs are undertaken during the off-hours as far as possible. Routine inspections of cars are made very frequently, often daily, before each service run. More thorough inspections are undertaken on a rotating schedule basis, perhaps monthly.

Also of considerable interest is the significant underground track mileage in the transit systems listed in Table I. As discussed later, the noise within rapid transit cars operating in tunnels is much greater than that within the same cars operating above ground - and some noise control modifications have widely different effects on in-car noise above and below ground.

TABLE I. OVERVIEW OF U.S. RAPID TRANSIT SYSTEMS

RAPID TRANSIT SYSTEM	APPROXIMATE ROUTE MILEAGE*		RAIL TRANSIT CARS CURRENTLY** OPERATIONAL			Above Ground			Below Ground		
						Average Distance Between Stations (mi)	Average Speed** (mph)	Maximum Speed (mph)	Average Distance Between Stations (mi)	Average Speed** (mph)	Maximum Speed (mph)
	Total	Underground	Number	Builder	Year Built						
Boston MBTA (Mass. Bay Transit Authority)	23	9	38	Pullman	1923	0.65	23	50	0.5	18	45
			20	Pullman	1941						
			75	Pullman	1945						
			25	Pullman	1946						
			150	Pullman	1948						
			50	Pullman	1951						
			40	St. Louis	1952						
			100	Pullman	1957						
			25	Pullman	1959						
			92	Pullman	1963						
		76	Pullman	1970							
		691	**As of 1973								
Chicago (Chicago Transit Authority)	89	10	80	Cincinnati	1922-1925	0.66	25†	55	0.66	25†	55
			2	Pullman	1947						
			2	St. Louis	1948						
			200	St. Louis	1950-1951						
			306	St. Louis	1954-1956						
			210	St. Louis	1957-1959						
			50	St. Louis	1959-1960						
			180	Pullman	1964						
			150	Budd	1969-1970						
					1180						
Cleveland CTS (Cleveland Transit System)	19	0.3	87	St. Louis	1954-1958	1.1	32	55	-	-	-
			20	Pullman	1967						
			10	Pullman	1970						
					117						

\*Rail rapid transit parts of systems only.

\*\*Route/travel time.

†Overall average, for above and below ground.

2025 RELEASE UNDER E.O. 14176

TABLE I. (Cont.)

RAPID TRANSIT SYSTEM	APPROXIMATE ROUTE MILEAGE*		RAIL TRANSIT CARS CURRENTLY** OPERATIONAL			Above Ground			Below Ground		
	Total	Underground	Number	Builder	Year Built	Average Distance Between Stations (mi)	Average Speed*** (mph)	Maximum Speed (mph)	Average Distance Between Stations (mi)	Average Speed*** (mph)	Maximum Speed (mph)
New York NYCTA (New York City Transit Authority)	240	137	750	A.C.P.	1946-1947	0.5	20	45	0.5	20	45
			10	Budd	1947						
			200	A.C.P.	1953						
			1100	St. Louis	1954-1956						
			110	A.C.P.	1958						
			230	St. Louis	1959						
			100	A.C.P.	1959						
			556	St. Louis	1960-1961						
			964	St. Louis	1962						
			600	Budd	1963						
800	St. Louis	1965-1966									
640	St. Louis	1968-1970									
		6060		**As of 1971							
New York-New Jersey PATH (Port Authority Trans Hudson)	13	8	47	St. Louis	1956-1957	3.2	8(45) <sup>§</sup>	55	0.8	8	40
			206	St. Louis	1964-1967						
			46	Hawker-Siddley	1972-1973						
			299		**As of 1973						
Philadelphia SEPTA (Southeastern Penna. Transit Authority)	35	9	300	Brill	About 1935	0.5	25	60	0.5	25	60
			273	Budd	About 1960						
			573		**As of 1973						
Philadelphia-Camden PATCO (Port Authority Transit Corp.)	14	2.5	75	Budd	1958	1.6	39	75	0.3	25	40
			75		**As of 1973						
San Francisco BARTD (Bay Area Rapid Transit District)	75	25	250	Rohr	1971-1973	3.7	42	80	1.0 <sup>¶</sup>	40	40-50 <sup>¶</sup>
			100	Rohr	1973						
			350		**As of 1973						

\*Rail rapid transit parts of systems only.

\*\*Route/travel time.

†Overall average, for above and below ground.

§8 mph between 2 stations 1/2 mi apart; 45 mph between 2 stations 2.5 mi apart

¶Varies greatly (2 blocks to 2 miles).

Finally, since the noise in transit cars increases with increasing vehicle speed (as also discussed later in detail), the speeds listed in Table I are of some importance in assessing the noise and the noise control problems.

#### Car Builders and the Procurement Process

In the past 15 years, ACF Industries and St. Louis Car Co. have ceased all passenger car production and Budd has terminated its production of self-propelled cars, leaving Pullman-Standard as the only remaining old-line car builder.

However, new companies have entered the transit car building field in the past few years. Rohr Corp. supplied the cars for the new BARTD system, the Boeing Vertol Co. has developed and built a pair of state-of-the-art cars (SOAC) now undergoing testing under the Urban Mass Transit Administration's Rapid Rail Systems and Vehicles Programs, LTV won a contract to supply vehicles for the new Dallas airport system, and General Electric, who used to supply only transit car components, has begun to bid as a prime car supplier.

Transit systems wishing to purchase new cars generally prepare detailed specifications, which are submitted to potential suppliers for bidding.\* Car builders generally do most of their design work in the course of preparing bids. In effect, a bid typically indicates little more than the proposed price for the cars to be supplied; the successful bidder usually is the one who can meet the prescribed specifications and schedules reliably at the *lowest cost*.

---

\*Except for some of the most recent ones, these specifications did not include any quantitative noise performance requirements; some of the very newest ones, on the other hand, specify rather stringent noise performance requirements, acceptance tests, and payment penalties for not meeting these requirements.

Each car proposed in response to a bid request is in essence a new design aimed at meeting the specific requirements of the procurement. Since the designer can take noise control techniques and components into account during the early design stages, one may expect that many of these noise control considerations can be implemented at relatively low cost. However, except for some very rare bold innovations, most new car designs draw heavily on established technology, so that improved (and quieter) designs tend more to evolve slowly (in a rather conservative industry) than to appear overnight.

Rapid transit cars constitute a relatively complex assemblage of systems and components. Builders typically build only the car structure and body shell - they procure from other suppliers, integrate, and assemble all other parts, including such heavy items as trucks, wheels, axles and propulsion motors, such major sub-systems as controls, communication, and HVAC equipment, and such smaller items as seats, doors, door operators, public address systems, and lighting.

## NOISE IN TRANSIT CARS

### Where Noise Originates

The primary sources of steady noise\* in rapid transit cars and the relation of these sources to passengers may be visualized with the aid of Fig. 1, which shows a schematic section through a transit car.

These sources, in typical order of importance, are:

1. Wheel/rail interaction
2. Propulsion (traction) system
3. Auxiliary (undercar) equipment
4. Air conditioning and distribution systems

The steady "roar" noise due to interaction between wheels and rails typically constitutes the dominant noise component in modern rapid transit cars running on welded tangent track. For cars running on jointed track, an impact noise associated with passage of the wheels over joints in the track is added to the roar noise. Not much is known at present about the basic roar-noise-producing mechanism, but it is thought to be associated with wheel vibrations induced by small irregularities on the rail interacting with the wheel tread, which also may contain small surface irregularities. (It is well known that reduction of the irregularities in the track - e.g., by grinding - reduces the

---

\*By "steady" noise is meant a noise that is of long enough duration to make an appreciable contribution to the time-average acoustic energy, computed for a trip or portion of a trip lasting at least several minutes. Noise of short duration, such as the screech produced by car wheels traversing tight curves, contributes relatively little to the noise exposure of passengers, even though this noise may be rather intense. Thus, short-duration noise is excluded from consideration here.

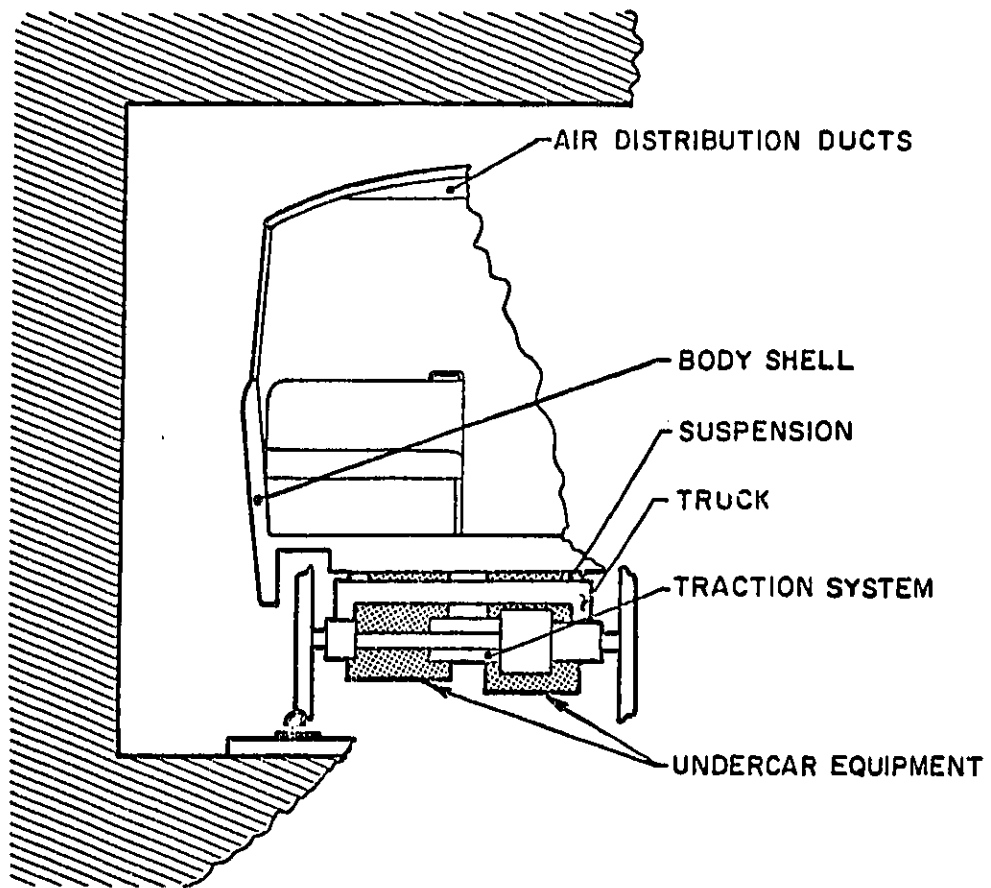

FIG. 1. SCHEMATIC SECTION OF TRANSIT CAR IN TUNNEL

roar noise.) The wheel vibrations radiate "airborne" sound (much like a loudspeaker membrane), but also are transmitted to the vehicle shell via structural paths, leading to sound radiation from the shell. The direct airborne radiation component generally is by far the more significant.

The propulsion equipment typically includes one or more traction motors per truck, reduction gearing, and fans or blowers for cooling the motors. Each of these components tend to produce both airborne noise and structural vibrations.

Auxiliary equipment, which generally is mounted under the car, may include air conditioning compressors and condensers (with associated fans, pumps, motors), air compressors and other pneumatic system components, hydraulic systems, motor-alternator sets, and electrical and electronic systems (some of which may include cooling fans). Again, each of these items tends to produce both noise and vibrations.

Those portions of the air conditioning and distribution systems which are not mounted under the car may also contribute to the noise environment in the passenger space. For example, noise is likely to be produced by air circulation fans, by air flow in ducts, and by air emerging through grillages and perforations. For reasonably well designed equipment, air conditioning noise tends not to be an important factor.

#### How Noise Reaches Passengers

Of all the aforementioned noise sources, only those associated with the air distribution system communicate directly with the passenger compartment. For all of the other sources one may expect the noise to reach the passengers via a multitude of paths. As indicated schematically in Fig. 2, these may involve:



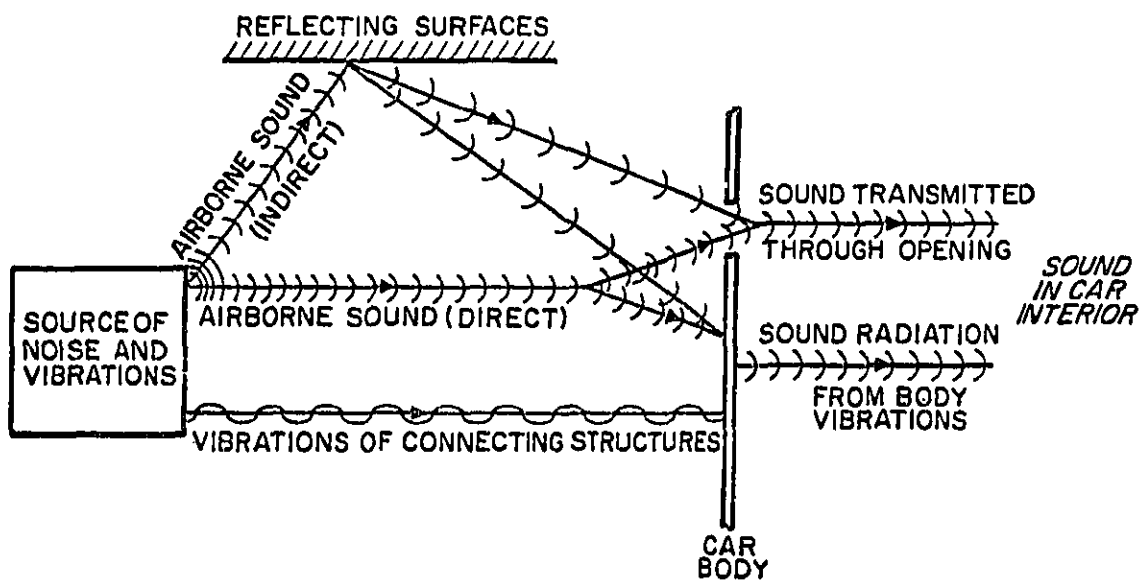

FIG. 2. SCHEMATIC DIAGRAM OF PATHS FOR SOUND TRANSMISSION INTO CAR INTERIOR

1. Transmission of airborne sound from the source to the vehicle body, with sound entering the passenger compartment
  - (a) via openings (e.g., air intakes or exhaust vents, gaps in door seals, open windows), or
  - (b) by setting the body shell into vibration, causing it to radiate sound; and
2. Transmission of vibrations to the body shell via structural paths (e.g., including bearings, mountings, fastenings), resulting in airborne noise radiation into the passenger compartment.

Transmission of (airborne) sound from sources outside the car to the vehicle body may take place along relatively direct "line of sight" paths, and along more circuitous paths involving reflections from the trackbed, the ground, and from tunnel surfaces. For vehicles located in the open, one may expect much of the airborne noise to reach the vehicle from its underside; for vehicles in tunnels, on the other hand, one may expect noise to reach it essentially from all directions. In typical tunnels with little acoustic absorption, multiple reflections tend to make the sound field around vehicles relatively uniform; since no sound can escape to the side, these sound fields also tend to be relatively intense.

#### The Noise Environment in Cars

Since, as evident from the foregoing discussion, the noise in a car depends to some extent on whether the car is in a tunnel or in the open, it is reasonable to treat these two cases separately. In addition, the two most important ones of the previously listed noise sources depend very significantly on the speed of the vehicle, so that car speed may be expected to be an important parameter affecting the in-car noise.

The available data\* on the steady noise inside rapid transit cars is summarized in Figs. 3 and 4, in terms of (overall) A-weighted noise levels, plotted as functions of speed. Corresponding frequency spectra, as far as available, are collected in Appendix A. Presentation of the information here in terms of A-weighted levels has been chosen because these levels have become widely accepted as a basis both for judging noise annoyance and for establishing hearing conservation criteria.

Figure 3 pertains to transit cars travelling on tangent (straight) track, on the surface of the ground (not on elevated structures), whereas Fig. 4 pertains to cars on similar track in tunnels. The data in both figures corresponds to track that contains no unusual roughness or irregularities.

The higher-speed data of Fig. 3 may be seen to fall into three bands - two of which, if continued toward lower speeds, do not encompass the lower speed data very well. This state of affairs also is evident in Fig. 4 and has a reasonable explanation. At zero speeds, the noise in a car is due only to air-handling and auxiliary equipment; contributions from the propulsion system and from dynamic wheel/rail interaction obviously are absent. With increasing speed, these contributions increase until they eventually predominate. Thus, the low-speed and higher-speed regions of these two figures essentially correspond to dominance

---

\*Data appearing in the literature without corresponding speed information has not been included. Neither has such data from which A-weighted overall levels cannot be deduced reliably.

The presence of passengers in cars changes their acoustical characteristics somewhat, and therefore also affects the noise environment in cars to some extent. However, these effects are relatively minor and generally well within the spread of the data summarized here.

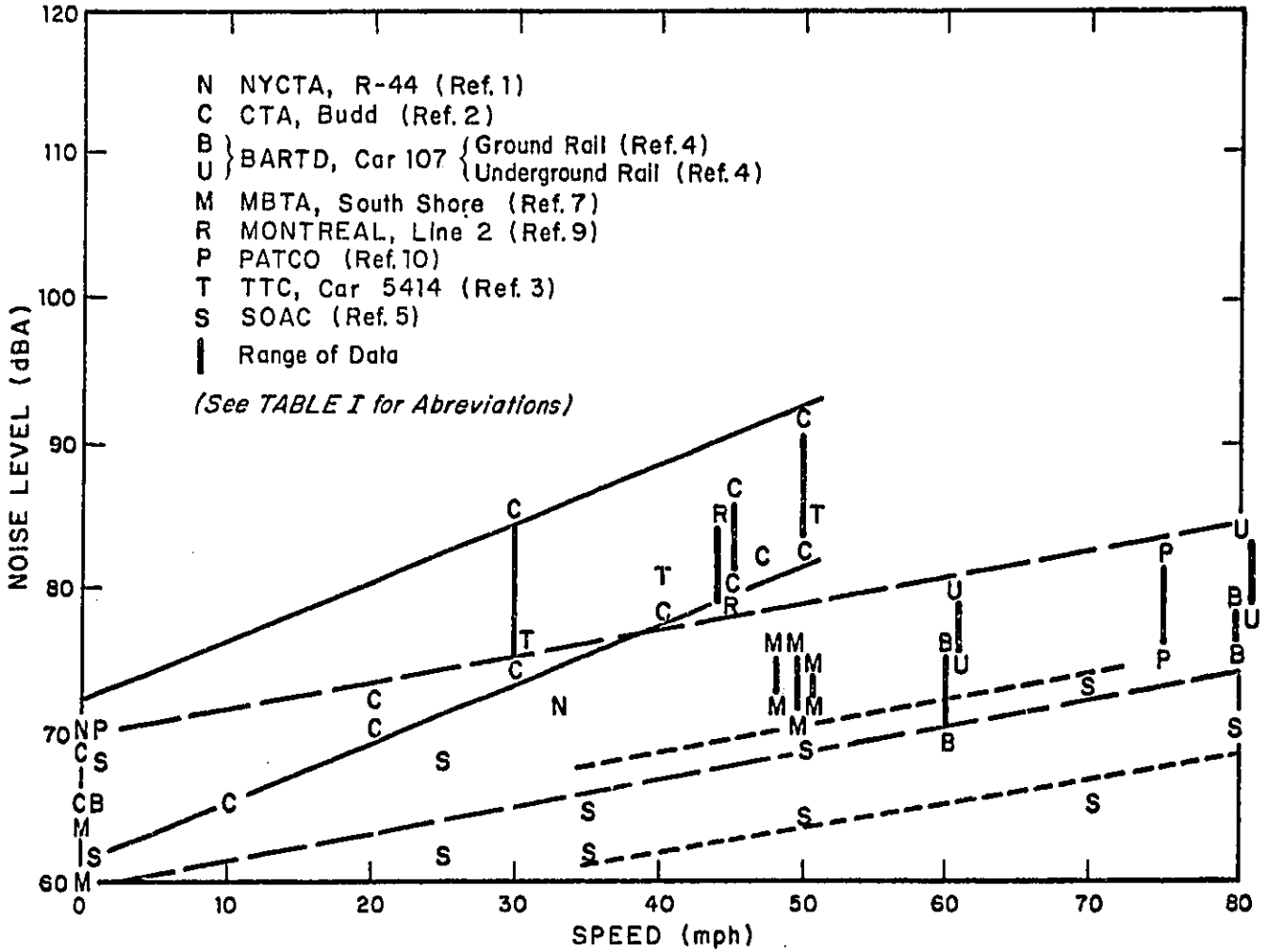

FIG. 3. STEADY NOISE LEVELS IN TRANSIT CARS ON TANGENT TRACK OF GOOD QUALITY ABOVE GROUND

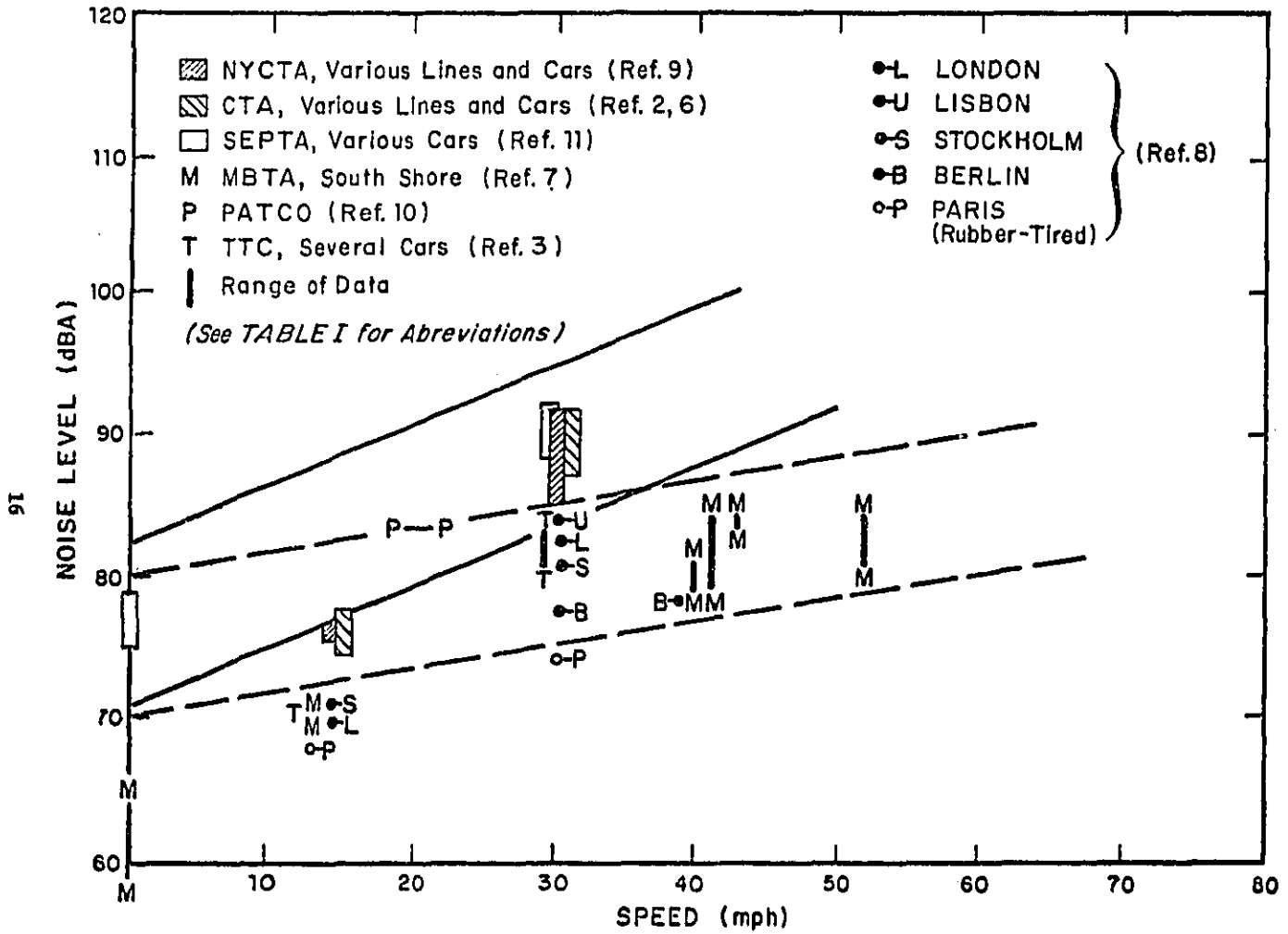

FIG. 4. STEADY NOISE LEVELS IN TRANSIT CARS IN SUBWAY TUNNELS

of different noise sources. (The fact that one band of Fig. 3 also includes the lower-speed data probably is fortuitous.) Because of the lower noise levels at low speeds, and because transit systems tend to operate their vehicles at the greatest possible speeds consistent with safety and acceleration/deceleration limitations, the lower-speed information is of limited interest. Consequently, the later discussion of noise control costs focuses on the higher-speed region.

The differences in the noise levels associated with the various bands of Fig. 3 may be ascribed to differences in the car. The data in the highest band (enclosed by solid lines, and increasing on the average by about 4 dBA per 10 mph increase in speed) corresponds to cars of somewhat older designs than the data in the middle band (enclosed by long dashed lines, and increasing on the average by about 2 dBA per 10 mph increase in speed). The lowest band (short dashed lines, also increasing at 2 dBA per 10 mph) corresponds to a single very new demonstration vehicle.

Although the data pertaining to in-car noise in tunnels does not suffice for the drawing of trend-indicating bands in Fig. 4 like those of Fig. 3, bands are indicated in Fig. 4. These have been established simply by shifting the upper two bands of Fig. 3 upward (both by the same amount), so that they enclose most of the significant higher-speed data. This 10 dBA shift indicates that the noise level in a given vehicle at a given speed is 10 dBA higher on the average when the vehicle is in a tunnel than when it is on the surface.

From Fig. 3 one may determine that the noise level  $L$  in the most quiet transit cars currently in service, when operating at a speed  $V$  above ground, may be estimated from

$$L(\text{dBA}) = 65 + 0.18 V(\text{mph})$$

within  $\pm 5$  dBA. In view of Fig. 4, one finds that one may estimate the noise level in such cars in tunnels (for speeds above 20 mph) by adding 10 dBA to the above-ground noise level obtained from the foregoing relation.

One may also note that at any particular speed above 35 mph the state-of-the-art car is about 7 dBA quieter on the average than currently operating cars.

## NOISE REDUCTION AND ITS COSTS

### Car Design Modifications for Noise Reduction

The most fruitful approach toward the reduction of noise generally consists of modification of the noise sources so as to reduce the noise generation. Application of this approach to transit cars requires modification of the wheel/rail interaction and possibly also of the propulsion and under-car equipment.

The only practical means presently available for reducing wheel/rail roar noise at its source consists of replacing the standard steel wheels in present use by "resilient" wheels. Several such wheel designs are available and have been tested; all incorporate rubber elements between the steel rim running surfaces and the central wheel discs, so as to achieve some vibration isolation between the rim and central disc.

Reductions in the noise produced by the propulsion and auxiliary equipment sources usually may be obtained by choosing quieter components (e.g., helical instead of spur gears, slow centrifugal blowers instead of high-speed axial flow fans) and by taking appropriate care in system design (to avoid turbulent fluid flows, reduce mechanical vibrations, avoid impacts, rattles, buzzing).

One may also reduce the noise reaching the passengers by obstructing the dominant propagation paths. Thus, one may place acoustical enclosures around noisy equipment components, and possibly even around the wheels (although wheel enclosures are likely to be impractical). One may also increase the attenuation provided by the body shell by sealing all openings as well as possible, providing mufflers for all openings that cannot be sealed, and using shell structures that permit less sound transmission. Such structures, for example, might be of a double-wall



or "shell within a shell" type. Similarly, one may impede the propagation of vibrations (which lead to sound radiation in the passenger space, as previously discussed), e.g., by use of vibration isolation in the form of rubber "shock mounts", elastomeric bushings, or air springs.

Finally, one may reduce the intensity of the sound fields generated in the passenger space by the various sources (and paths) somewhat by increasing the acoustic absorption in the passenger compartments, for example by installing acoustical ceiling treatment, carpets and/or upholstery.

#### Costs and Benefits

Table II lists the various feasible car modifications that may be expected to result in reductions of in-car noise, together with the expected magnitudes of these reductions, and the associated estimated weight penalties and costs. For modifications that affect noise in vehicles on grade differently from that in vehicles in tunnels, two different values are indicated. The initial costs of these noise control modifications listed in the table represent the associated increase in cost of *new* cars; corresponding retrofitting of cars in current use is likely to be prohibitively costly and is not considered here. The "Remarks" column contains primarily notes concerning technical aspects of the modifications.

Inspection of Table II leads one to the following conclusions:

- (1) Use of a floated interior shell is the one single modification capable of providing the greatest noise reduction. However, this modification involves considerable cost and weight penalties.

TABLE II. IN-CAR NOISE REDUCTIONS AND COSTS ASSOCIATED WITH TRANSIT CAR DESIGN MODIFICATIONS

MODIFICATION	Decrease*** in Steady In-car Noise Above 30 mph (dBA)	Estimated Average Incremental Costs per car (\$1000)*		Weight Penalty per car** (1000 lb)	REMARKS
		Initial	Operating		
<u>Resilient Wheels</u>	5	3.2 (Approx. \$400/wheel)	-0.3/year	N	Operating cost reduction due to possibility of replacement of worn rims instead of entire wheels.
<u>Quieter Components</u>					
<u>Propulsion</u>					
Motor and cooling fan	2	N	N	N	Modification of fan and cooling air passages. Higher quality gears, gear unit oil cooling.
Gearing	3	10	N	0.1	
<u>Undercar Auxiliaries</u>					
Electrical	N,E	N	N	N	} Primary noise due to air cooling, if any.
Electronic	N,E	N	N	N	
Motor-alternators	S,E	N	N	N	
Hydraulic	N,E	N	N	N	Noise due to pumps, valves, motors. Use rotary instead of reciprocating equipment.
Pneumatic	S,E	N	N	N	Primary noise due to compressors, valves. Use rotary instead of reciprocating equipment.
Air conditioning	S	N	N	N	Primary noise due to compressors, condenser cooling air fans.
<u>Acoustical Enclosures for above components</u>	N,E	0.5	N	0.5	Enclosures include provision for cooling, including muffling of air passages for air cooling.
<u>Vibration Isolation of above components</u>	2	N	N	N	
<u>Improved Vibration Isolation between Trucks and Body</u>	2	1.0	N	N	Reduces transmission of vibrations originating from wheel/rail interaction and propulsion components.
<u>Improved Acoustical Performance of Body</u>					
<u>Double-pane windows or acoustical glass</u>	1 on grade, 3 in tunnel	1.2 (\$75/window)	0.2/year(R)	1.5	Double-pane windows imply need for added saah and structural complexity.
Secondary (floated) floor	3 on grade, 2 in tunnel	2	0.2/year(R)	1.5	
Tighter door seals	1	1	0.2/year(R)	N	Require development to be practical; necessitate more frequency replacement to maintain seal.
Air duct muffling	2	1	N	N	Cleanability requirements usually limit design.
Floated (isolated) interior shell	6 on grade, 10 in tunnel	25	0.2/year(R)	3.0	Includes appropriate windows and door seals.
<u>Added Absorption Inside Car</u>	2	1	N	0.2	Space limitations, cleaning requirements and vandal-proofing limit design and usable materials.
<u>Quieted Air Distribution System</u>	5	0.5	N	0.2	Space limitations limit design.

N = negligible

E = modifications affect exterior noise primarily

S = source contributed significantly only to noise in stationary or slowly moving cars

R = repairs, replacement, and maintenance

\*Typical car cost \$250,000 to 300,000

\*\*Typical car weighs 60,000 to 100,000 lb. Cost of weight penalty is \$1.50 to \$2.00 per pound.

\*\*\*Amounts of decrease indicated correspond to implementation of only one modification at a time. Decreases due to multiple modifications are not additive in general.

- (2) Many other modifications, which effect limited noise reductions, may be implemented at little cost.
- (3) Many modifications affect only the low-speed in-car noise, and not the high-speed noise, which is of primary interest here.

#### Incremental Costs of Quieter Cars

The decreases in the high-speed in-car noise expected to be obtained by use of virtually all technically sensible combinations of noise control modifications are indicated in Table III, together with the associated incremental costs.

For purposes of preparing this table, it was assumed that anyone desiring quieter cars at minimum cost would install quieter motor and cooling fans, at the same time improving the vibration isolation of the noisy propulsion and undercar components, since these two modifications are estimated to reduce the noise by 3 dBA, at essentially zero incremental cost. In addition, it was assumed that of the four approaches involving minor design improvements and/or development - namely: (1) improved vibration isolation between trucks and body, (2) improved air duct muffling, (3) increased acoustical absorption inside car, and (4) tighter door seals - one would always implement either all or none.

Figure 5 shows the noise reductions obtained with the various combinations of noise control modifications, as a function of the initial incremental costs they add to a car. This figure permits one to select that combination which gives the greatest amount of noise reduction for a given incremental initial cost, or to determine the minimum cost associated with a given amount of noise reduction. In addition, Fig. 5 also permits one to

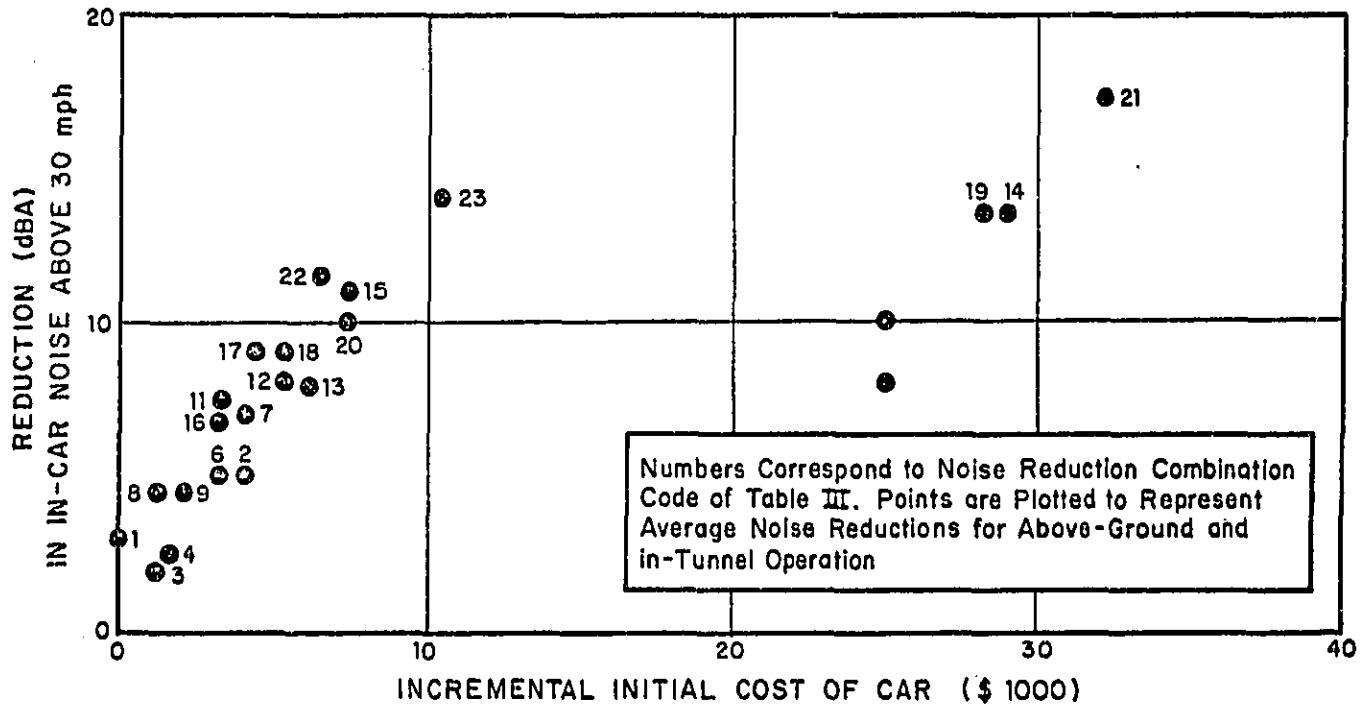

FIG. 5. INCREMENTAL COSTS OF NOISE REDUCTION

eliminate from consideration some combinations that are clearly less cost-effective than others; for example, since combinations 17 and 18 produce the same amount of noise reduction, but 17 is less costly, one would be inclined not to consider 18 further.

However, in order to consider the total costs of noise-control design modifications more meaningfully, one must consider the operating costs in addition to the initial costs on which Fig. 5 is based. One may reduce initial and operating costs to a single index by discounting the future incremental costs to the present day at an appropriate interest rate and adding this discounted cost to the increase in initial cost. The result is the net discounted cost increase. Corresponding values are shown in Table III, based on a car service life of 25 years and on an assumed annual interest rate of 8% (which is a representative value for public projects).

Figure 6 is analogous to Fig. 5, but is based on the aforementioned net discounted cost increase, instead of on the incremental initial cost. The same remarks made above in relation to Fig. 5 apply also to Fig. 6.

Table IV summarizes the minimum costs associated with achieving various levels of in-car noise reduction by car design modifications. It is a coincidental effect of the various combinations of initial and operating costs listed in Table III (as well as of the car life times and interest rates used in the discounted value computations) that the noise control modifications which are most desirable on the initial cost basis are also most desirable on the net discounted value basis.

TABLE III. NOISE REDUCTIONS DUE TO COMBINATIONS OF MODIFICATIONS, AND ASSOCIATED COSTS

Combination Code	Component Isolation + Quieter Fans	Body Isolation + Muffling + Absorption + Door Seals	Improved Windows	Floated Floor	Floated Shell	Resilient Wheels	Noise Decrease (dBA)**	Increase in Initial Cost (K\$)	Increase in Operating Cost (K\$/Year)	Net Discounted Cost Increase* (K\$)
1	x						3	-	-	-
2		x					5	4	0.2	14.7
3			x				1-3	1.2	0.2	3.3
4				x			3-2	2	0.2	4.1
5					x		6-10	25	0.2	27.1
6						x	5	3.2	-0.3	*0
7	x	x					7	4	0.2	6.1
8	x		x				4-5	1.2	0.2	3.3
9	x			x			5-4	2	0.2	4.1
10	x				x		8-12	25	0.2	27.1
11	x					x	7.5	3.2	-0.3	*0
12	x	x	x				7.5-9	5.2	0.4	9.5
13	x	x		x			8	6	0.4	10.3
14	x	x			x		12-15	29	0.4	33.3
15	x	x				x	11	7.2	-0.1	7.1
16	x		x	x			6.5-7	3.2	0.4	7.5
17	x		x			x	8.5-9.5	4.4	-0.1	3.3
18	x			x		x	9	5.2	-0.1	4.3
19	x				x	x	11.5-15.5	28.2	-0.1	27.1
20	x	x	x	x			10	7.2	0.6	13.6
21	x	x			x	x	16-8.5	32.2	0.1	33.3
22	x		x	x		x	11-12	6.4	0.1	7.5
23	x	x	x	x		x	14	10.4	0.3	13.6

\*For 8% annual interest rate, 25 year life time

\*\*Where two numbers are given, the first pertains to above-ground and the second to in-tunnel operation.

TABLE IV  
 MINIMUM COSTS ASSOCIATED WITH NOISE REDUCTION MODIFICATIONS

In-Car Noise Reduction Above 30 mph	Incremental Costs (\$1000)	
	Initial*	Net Discounted*
5 dBA	3.2 [11]	≈0 [11]
10 dBA	7.2 [15]	7.1 [15]
15 dBA	32.2 [21]	33.3 [21]

\*Numbers in brackets refer to best combination of noise control design modifications listed in Table III.

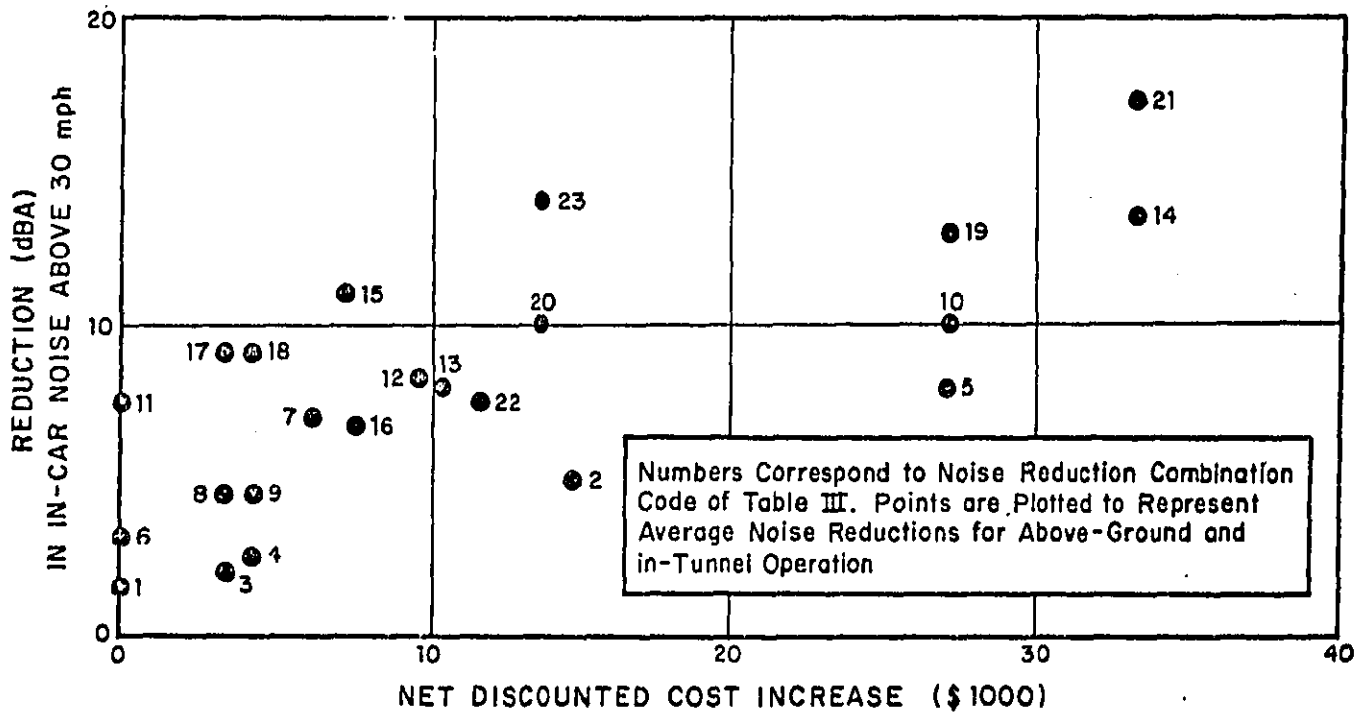

FIG. 6. NET DISCOUNTED COST INCREASE (FOR 8% ANNUAL INTEREST RATE, 25 YEAR LIFE) ASSOCIATED WITH NOISE REDUCTION



#### REFERENCES

1. A. Paolillo, Memorandum to D.T. Scannell re "Noise Measurements, R-44 Contract Cars," 21 August 1972.
2. W. Patterson, "Results of Field Tests on CTA Train, Conducted 6 September 1972".
3. Toronto Transit Commission, "Interim Report on Penn Resilient Wheels," October 31, 1969. (Test run between 27 August and 4 September 1969.)
4. G.P. Wilson, "BARDT Prototype Car 107 Noise Tests with Standard, Damped and Resilient Wheels: Ballast and Tie Tangent Track and Short Radius Subway Curves," Final Report, June 21, 1972.
5. F.N. Hiuser, "State-of-the-Art Car: Ready for Revenue Testing," *Railway Age*, January 8, 1973.
6. C. Hanson, E.E. Ungar, Measurements taken on 11 June 1973 on CTA Douglas Service.
7. E.J. Rickley, R.W. Quinn, "MBTA Rapid Transit System (Red Line) Wayside and In-Car Noise and Vibration Level Measurements," Report DOT-TSC-OST-72-31, August 1972.
8. E.W. Davis, "Comparison of Noise and Vibration Levels in Rapid Transit Vehicle Systems," National Capital Transportation Agency. Operations Research Inc. Technical Report 216. April 1964.
9. C.M. Harris, B.H. Aitken, "Noise in Subway Cars," *Sound and Vibration*, 5, No. 2, February 1971, pp. 12-14.
10. E.E. Ungar, Measurements taken on 12 July 1973.
11. J.W. Vigrass, Memorandum to R.B. Johnston, on "Resilient Wheels," 2 July 1973.

APPENDIX A  
IN-CAR NOISE SPECTRA

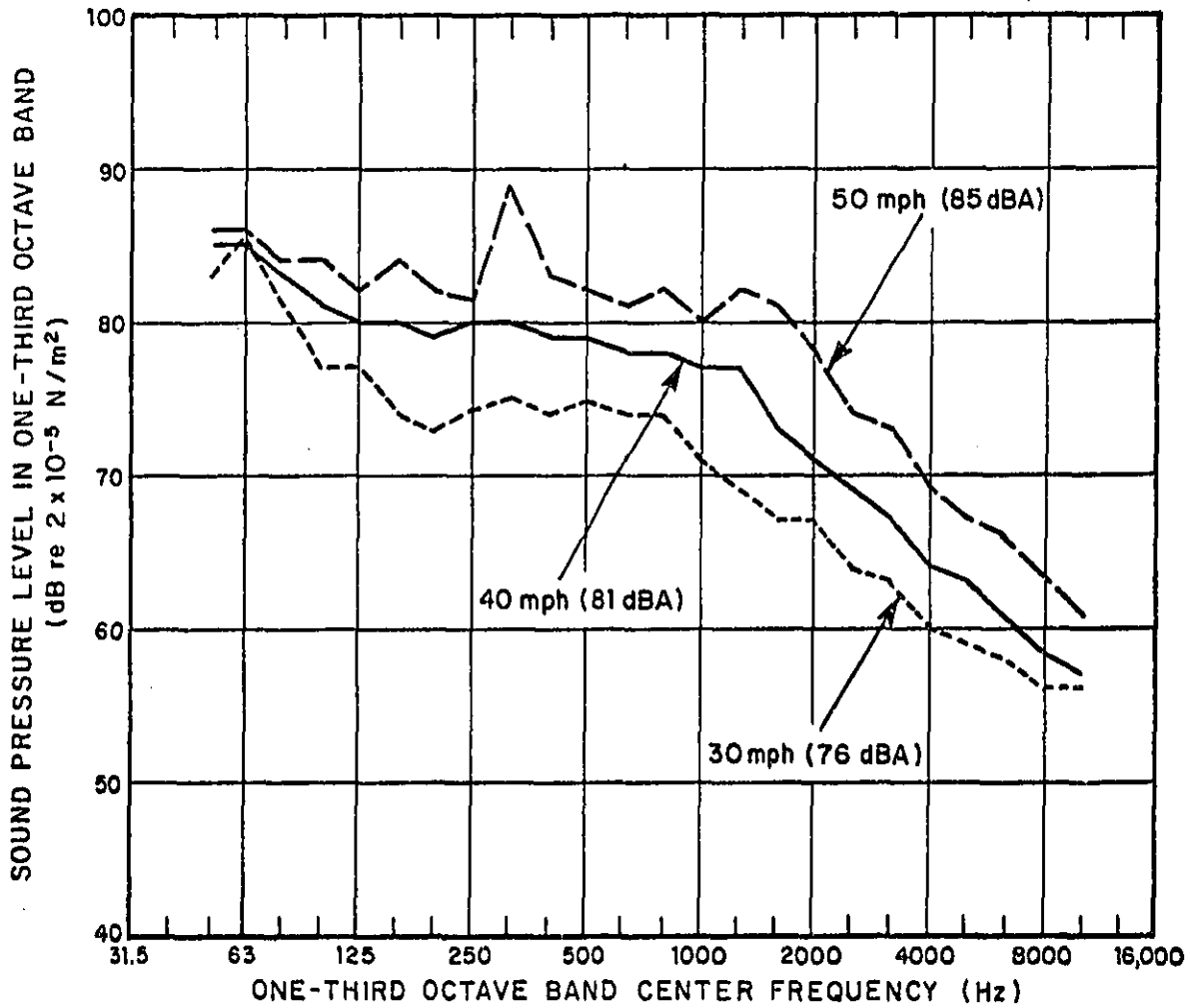

FIG. A.1. NOISE LEVELS IN TWC CAR 5414 ON TANGENT TRACK

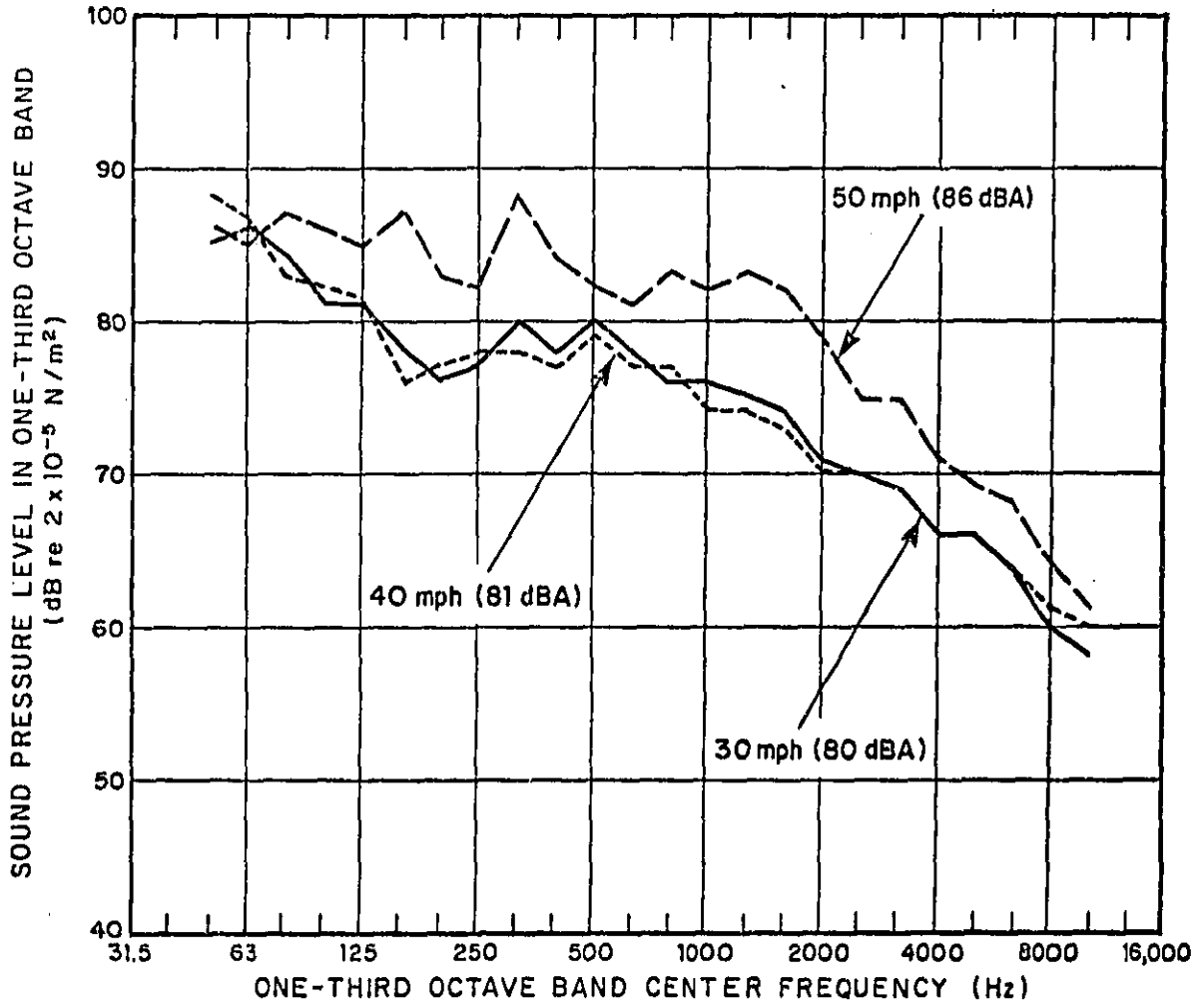

FIG. A.2. NOISE LEVELS IN TTC CAR 5414, ON CURVE

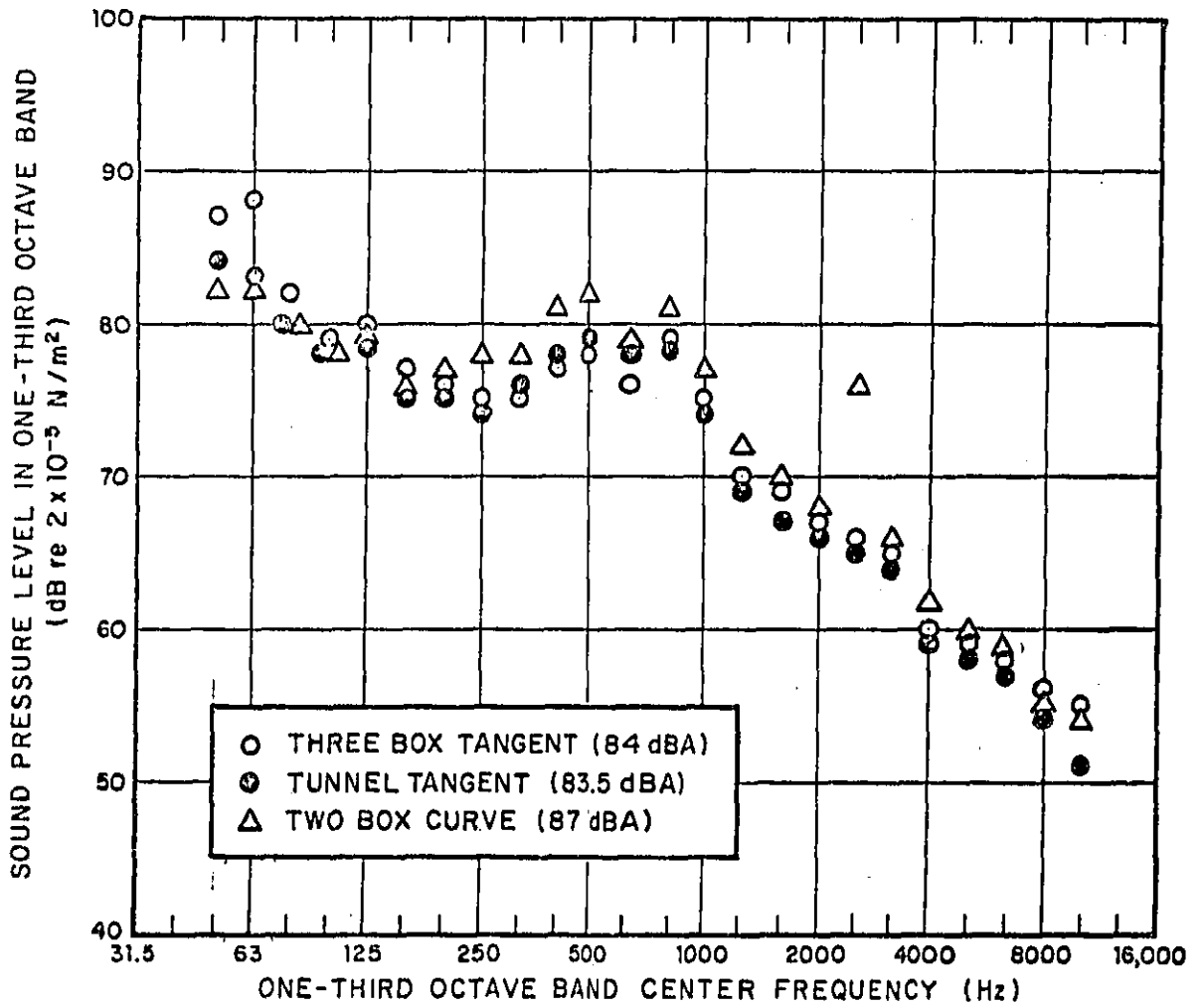

FIG. A.3. NOISE IN TTC CAR 5414, AT 30 MPH ON MAIN LINE

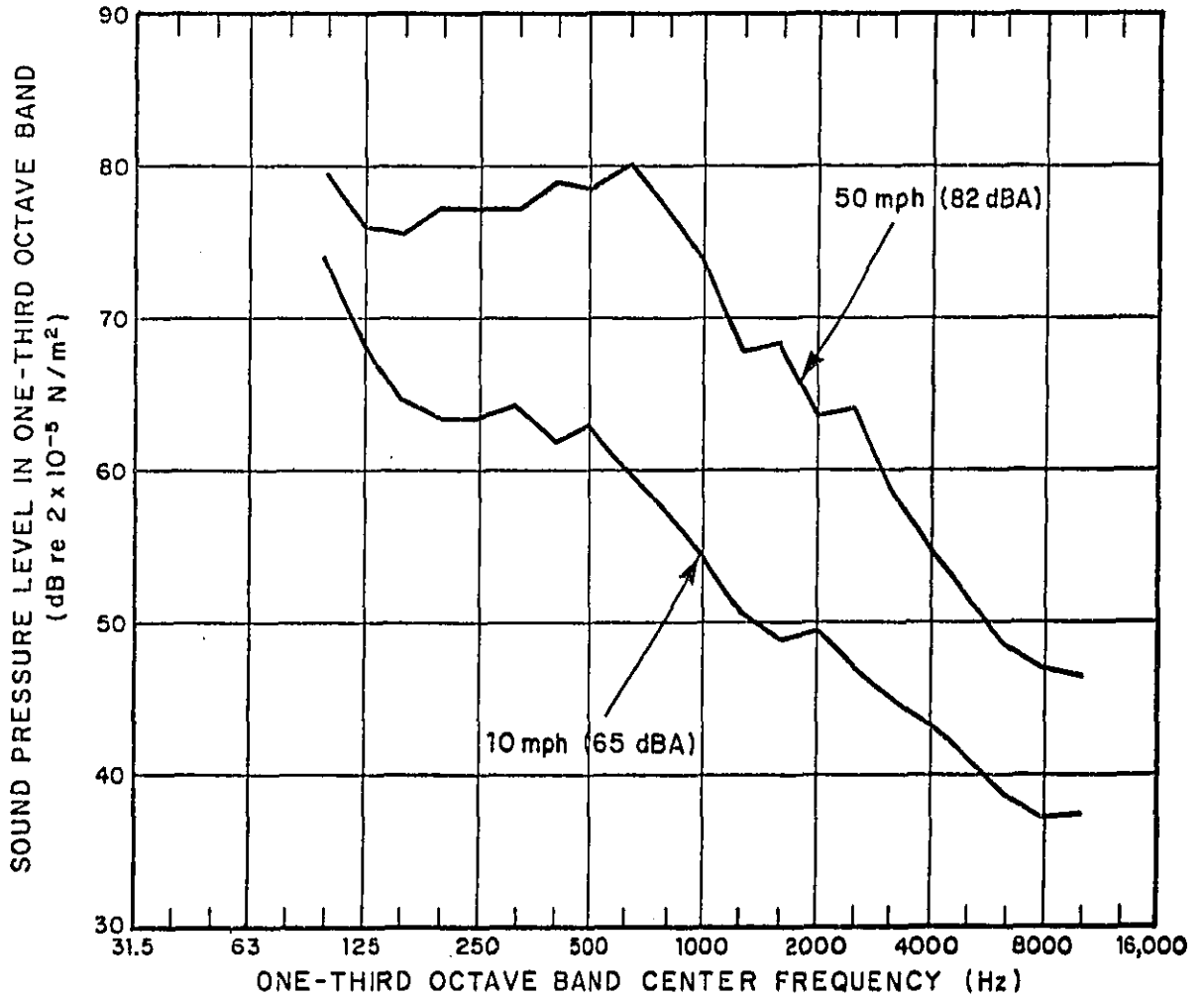

FIG. A.4. NOISE LEVELS IN CTA CARS 2251, 2252 (BUDD CO.) ON WELDED AND GROUND RAIL, ON GRADE, TIES ON BALLAST

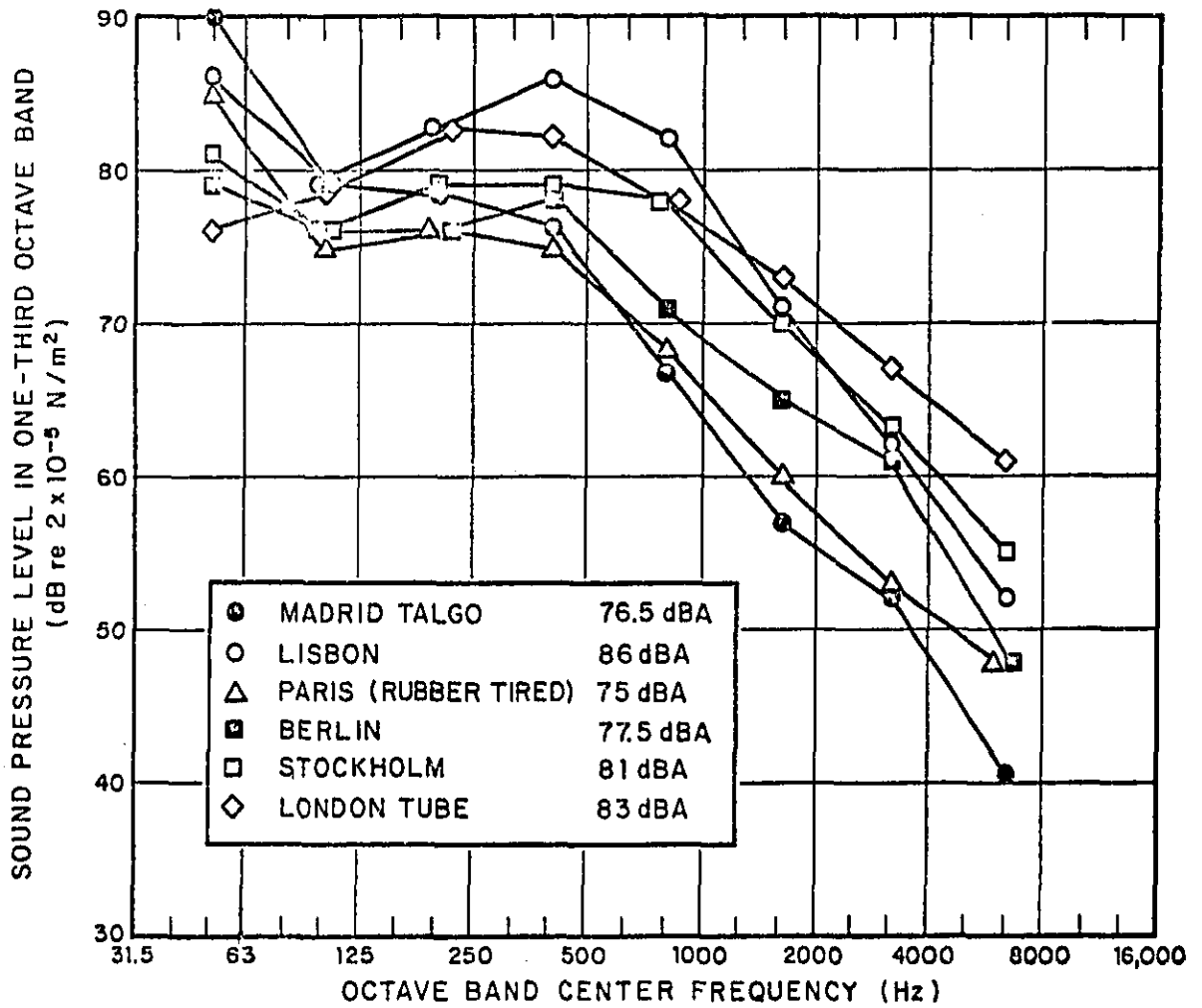

FIG. A.5. NOISE LEVELS IN SEVERAL EUROPEAN SUBWAY CARS

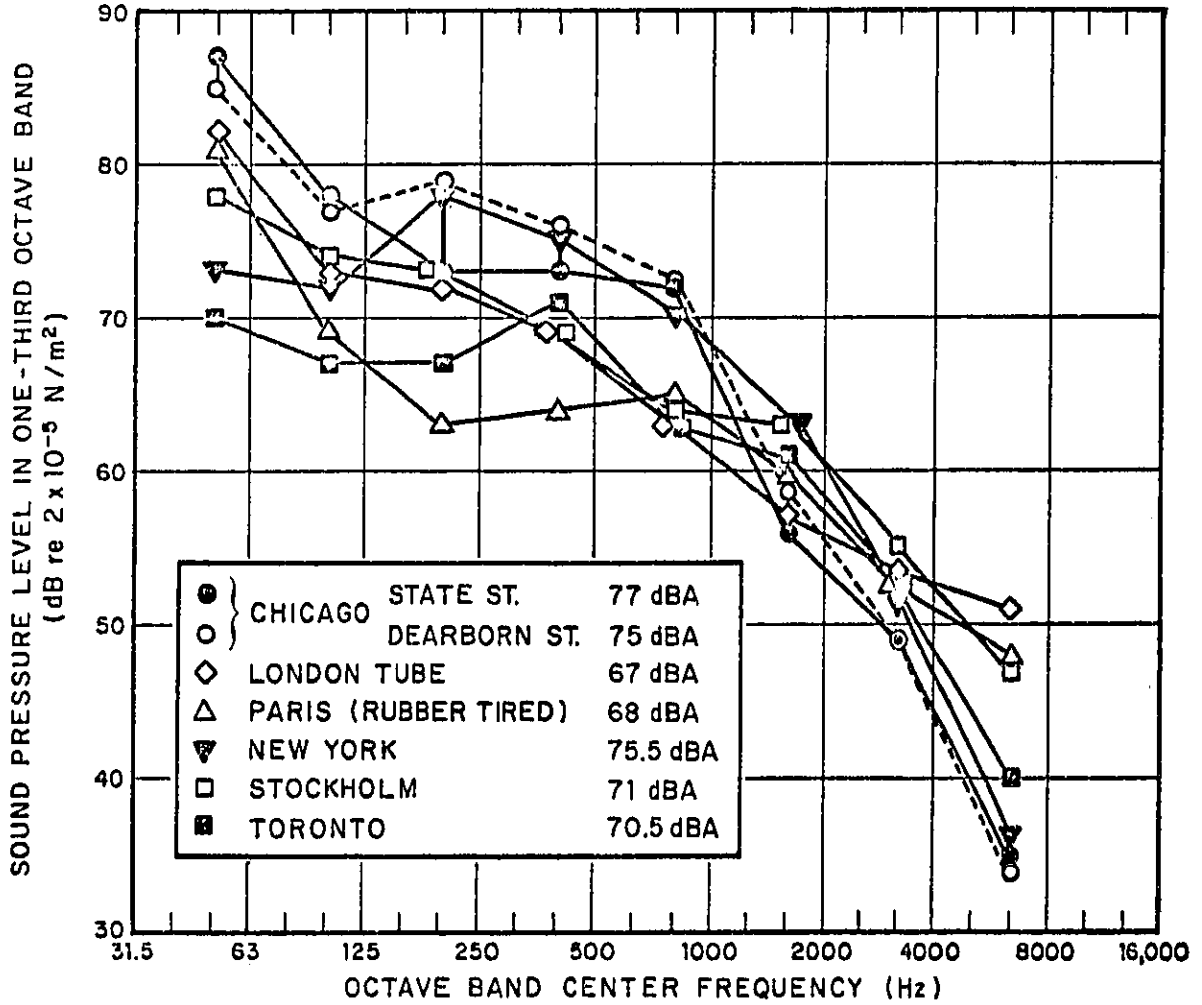

FIG. A.6. NOISE LEVELS IN SEVERAL SUBWAY CARS



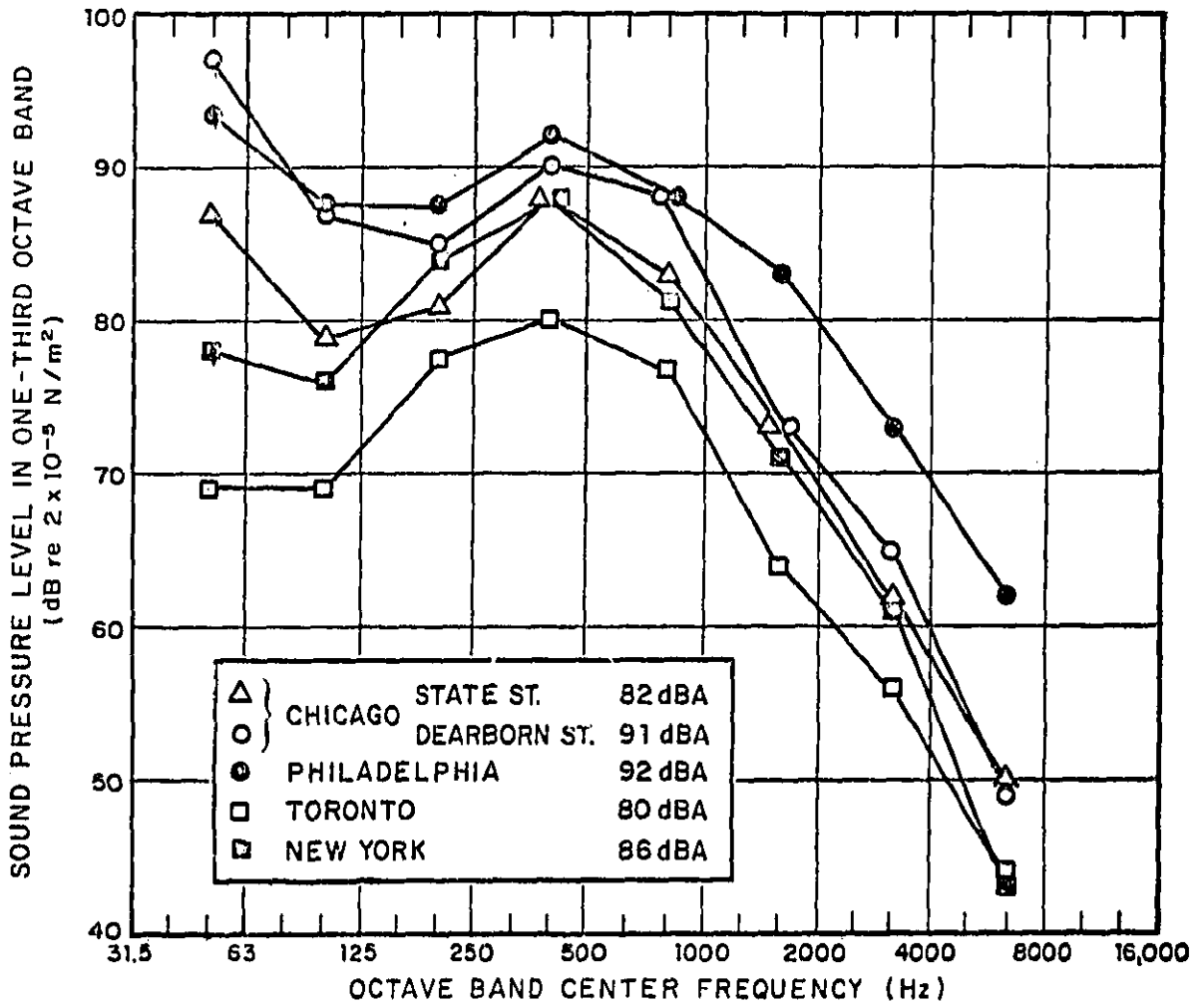

FIG. A.7. NOISE LEVELS IN SEVERAL NORTH AMERICAN SUBWAY CARS AT 30 mph

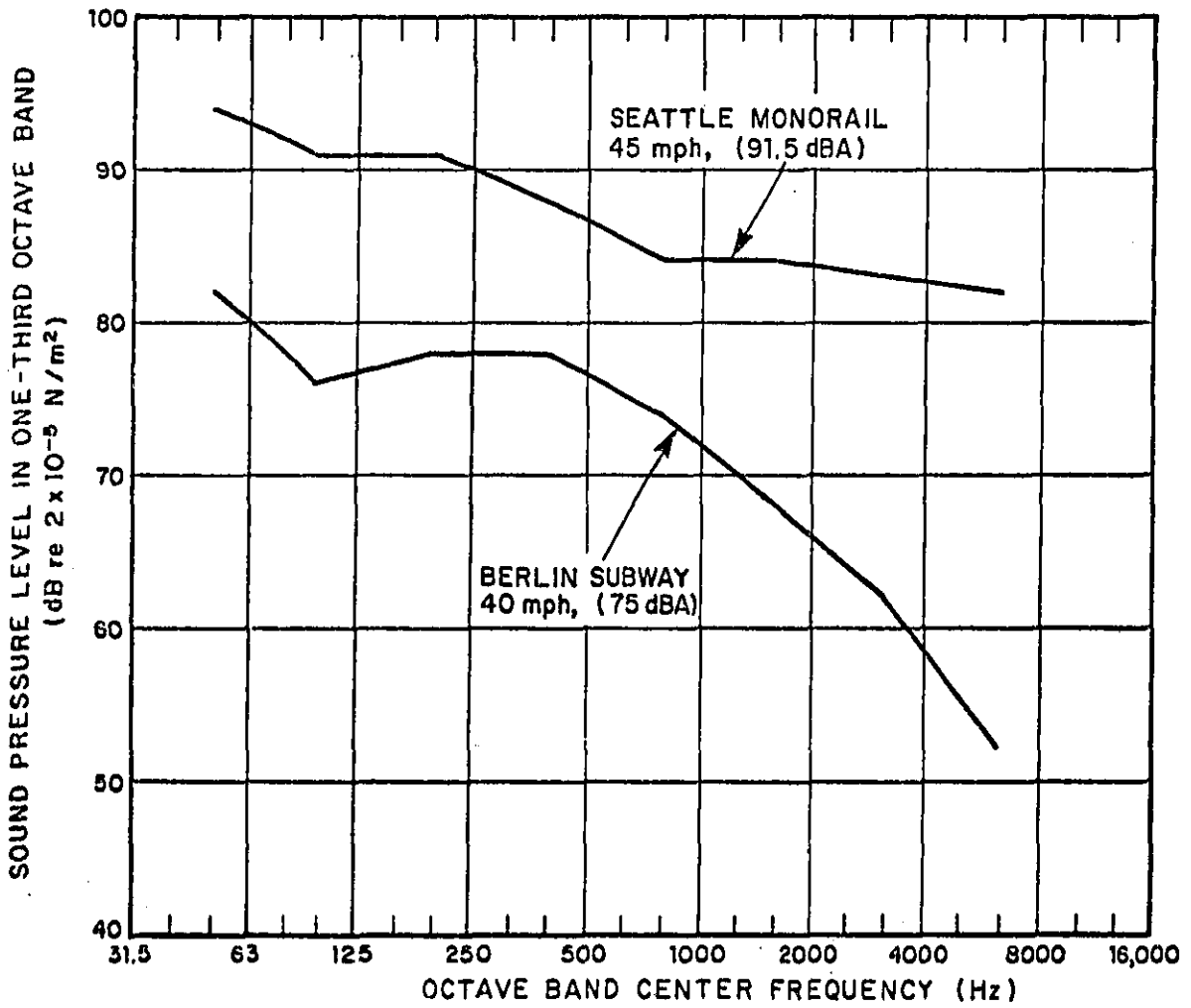

FIG. A.8. NOISE LEVELS IN TWO TRANSIT VEHICLES AT 40 AND 45 mph

APPENDIX B  
LIST OF TRANSIT SYSTEMS PERSONNEL

LIST OF TRANSIT SYSTEMS PERSONNEL CONTACTED

<u>System</u>	<u>Office Address and Telephone</u>	<u>Individuals Contacted</u>
Chicago Transit Authority (CTA)	Merchandise Mart Plaza, Rm. 7-144 Chicago, Illinois 60654 (312) 664-7200	Frank J. Cihak, Chief Equipment Engineer Equipment Research/Development Department (Ext. 516) Glenn M. Anderson, Senior Equipment Engineer, Rapid Transit Section Equipment Research/Development Department
Cleveland Transit System (CTS)	1404 East Ninth Street Cleveland, Ohio 44114 (216) 781-5100	Michael (Tim) Browne, Research Specialist Research and Planning (Ext. 385)
Massachusetts Bay Transit Authority (MBTA)	500 Arborway Jamaica Plain, Boston, Mass. 02130 (617) 722-6162	John J. Williams Planning and Development
New York City Transit Authority (NYCTA)	370 Jay Street Brooklyn, New York 11201 (212)	Anthony Paolillo Environmental Staff Division
Port Authority Transit Corporation (PATCO)	Lindenwold Yard, Lindenwold, New Jersey (609) 963-8300	J.W. (Bill) Vigrass Maintenance Superintendent (Ext. 35)
Port Authority Trans Hudson (PATH)	Rm. 65E, 1 World Trade Center New York, N. Y. 10047 (212) 466-3524	Nat Streitman, staff of Edward Farrelly, Assistant Chief, Rail Planning Division
Southeastern Pennsylvania Transit Authority (SEPTA)	200 West Wyoming Avenue Philadelphia, Penna. 19140 (215) 329-4000	B.J. Krant, Manager Administration
Bay Area Rapid Transit District (BARTD)	800 Madison Street Oakland, Calif. (415) 788-2278	Public Relations Department

BIBLIOGRAPHIC DATA SHEET		1. Report No. 550/9-74-012	2.	3. Recipient's Accession No.	
4. Title and Subtitle Noise in Rail Transit Cars Incremental Costs of Quieter Cars				5. Report Date June 1974	
7. Author(s) E.E. Ungar				6.	
9. Performing Organization Name and Address Bolt Beranek and Newman				8. Performing Organization Rep. No.	
12. Sponsoring Organization Name and Address Environmental Protection Agency Office of Noise Abatement & Control				10. Project/Task/Work Unit No.	
				11. Contract/Grant No. EPA No. 68-01-1539	
15. Supplementary Notes				13. Type of Report & Period Covered Final	
				14.	
16. Abstracts U.S. rail rapid transit systems, car operations, and the car building industry are described in relation to the procurement of quieter cars. The noise environment of passengers in rapid transit cars is discussed and the major noise sources and paths of noise transmission into cars are delineated. For essentially all combinations of car noise-control modifications deemed technically and economically feasible for implementation in new vehicles, estimates are presented of the associated noise reductions, initial costs, and operating costs. It is concluded that significant reductions in in-car noise under typical operating conditions can be achieved at incremental costs that are small percentages of the total car costs.					
17. Key Words and Document Analysis. 17a. Descriptors Transit systems Car Operations Car Builders Car design and modifications Noise in transit cars Costs and benefits of noise reduction					
17b. Identifiers/Open-Ended Terms					
17c. COSATI Field/Group					
18. Availability Statement Available at NTIS				19. Security Class (This Report) UNCLASSIFIED X	
				20. Security Class (This Page) UNCLASSIFIED X	
				21. No. of Pages	
				22. Price	